

Fuel Summary Report: Shippingport Light Water Breeder Reactor

*G. L. Olson
R. K. McCardell
D. B. Illum*

September 2002



*Idaho National Engineering and Environmental Laboratory
Bechtel BWXT Idaho, LLC*

NOTICE

This document has been prepared using the best available source of information. Every reasonable attempt has been made to ensure that the data have been correctly extracted and summarized from source documents. However, this document may contain incomplete and inaccurate information for reasons that include, without limitation:

1. The original source documents contained errors
2. Source documents could not be located that contained appropriate data and information
3. Source documents contained conflicting information, and engineering judgment has been used to select the data and information presented in this document
4. Additional data may exist but are yet to be located.

Document users need to ensure that this information is adequate for its intended use. Bechtel BWXT Idaho, LLC makes no representation or warranty, expressed or implied, as to the completeness, accuracy, or usability of the data or information contained in this report.

Fuel Summary Report: Shippingport Light Water Breeder Reactor

**G. L. Olson
R. K. McCardell
D. B. Illum**

September 2002

**Idaho National Engineering and Environmental Laboratory
Idaho Falls, Idaho 83415**

**Prepared for the
U.S. Department of Energy
Assistant Secretary for Environmental Management
Under DOE Idaho Operations Office
Contract DE-AC07-99ID13727**

ABSTRACT

The Shippingport Light Water Breeder Reactor (LWBR) was developed by Bettis Atomic Power Laboratory to demonstrate the potential of a water-cooled, thorium oxide fuel cycle breeder reactor. The LWBR core operated from 1977–82 without major incident. The fuel and fuel components suffered minimal damage during operation, and the reactor testing was deemed successful. Extensive destructive and nondestructive postirradiation examinations confirmed that the fuel was in good condition with minimal amounts of cladding deformities and fuel pellet cracks. Fuel was placed in wet storage upon arrival at the Expanded Core Facility, then dried and sent to the Idaho Nuclear Technology and Engineering Center for underground dry storage. It is likely that the fuel remains in good condition at its current underground dry storage location at the Idaho Nuclear Technology and Engineering Center. Reports show no indication of damage to the core associated with shipping, loading, or storage.

SUMMARY

The Shippingport Light Water Breeder Reactor (LWBR) was developed by Pittsburgh Naval Reactors Office and operated at Shippingport Atomic Power Station in Pennsylvania from 1977 to 1982. This test reactor was developed to prove the concept of a pressurized water breeder reactor. The reactor core consisted of 12 hexagonal seed modules, each of which was surrounded by a stationary blanket module. The 12 seed-blanket clusters (24 modules combined) were surrounded by 15 reflector modules, which contained rods with thoria pellets. Instead of using poison control rods, the core was designed with a movable seed, which was raised and lowered to control neutron absorption. The fuel consisted of binary ceramic pellets with 1 to 5% uranium in a thoria matrix. The uranium was more than 98% enriched with U-233, which was the only uranium isotope believed to be a feasible breeder in a light water reactor. To minimize neutron poisoning associated with hafnium and other impurities, the fuel rod cladding and some of the key structural components were made of a high-purity, high-performance zircaloy alloy.

Over the course of 5 years, the LWBR operated for about 29,000 effective full power hours. After the reactor was shut down, the modules were removed from the core, partially disassembled, and shipped to the Expanded Core Facility (ECF) at the Naval Reactor Facility at the Idaho National Engineering and Environmental Laboratory (INEEL). At ECF, the modules were placed in containers (liners), and the liners were submerged into positions within storage racks in the ECF water pits. Twelve of the 39 modules were remotely disassembled underwater to free the core components and fuel rods to facilitate postirradiation testing. Two of the 12 modules had their shells removed, and all 12 had their baseplates cut off. A sample of about 1000 rods were removed from the 12 modules for nondestructive and destructive evaluation. All of these rods were examined with a specially designed fuel assay gauge to obtain total fissile content, and 17 of the rods were dissolved and assayed to obtain the isotopic contents. At the conclusion of the testing, the intact loose rods were loaded into liners that were designed to hold seed, blanket, and reflector rods. The disassembled modules were clamped before being placed back into their liners.

In all, there are 47 liners of LWBR fuel addressed in this report: 12 liners contain seed modules, 12 contain blanket modules, 15 contain reflector modules, 7 contain the loose rods, and 1 contains leftover rods and rod sections from the LWBR research and development program. There is also an unirradiated LWBR seed module, not addressed in this report. The 47 liners were shipped from ECF to the Idaho Nuclear and Technology Engineering Center at the INEEL, where they were placed in dry underground storage.

ACKNOWLEDGMENTS

Special appreciation goes to Dr. Don Graczyk at Argonne National Laboratory-East, who made the destructive evaluation data available for our use, and to Steve McKinney formerly at LMITCO, who evaluated and summarized that data.

CONTENTS

ABSTRACT	iii
SUMMARY	iv
ACKNOWLEDGMENTS.....	v
ACRONYMS AND ABBREVIATIONS	xii
1. INTRODUCTION	1-1
2. REACTOR INFORMATION.....	2-1
2.1 Reactor.....	2-1
2.1.1 Location and Ownership	2-1
2.1.2 Reactor Type/Design.....	2-1
2.2 Reactor Parameters.....	2-5
2.2.1 Reactor Physical Dimensions.....	2-5
2.2.2 Core Grid Locations.....	2-5
2.2.3 Maximum Design Parameters.....	2-5
3. FUEL INFORMATION.....	3-1
3.1 Module Information	3-1
3.2 Fuel Information.....	3-3
3.2.1 Pellets.....	3-14
3.2.2 Rods	3-20
3.2.3 Beginning-of-Life Fissile Loading.....	3-25
3.3 Cladding	3-25
3.3.1 General Description of Cladding Types.....	3-25
3.3.2 Form.....	3-25
3.3.3 Composition.....	3-37
3.3.4 Thickness	3-37
4. OPERATING HISTORY	4-1
5. FUEL EVALUATION	5-1
5.1 End-of-Life Nondestructive and Destructive Examinations.....	5-1
5.1.1 Nondestructive Examinations	5-1
5.1.2 Destructive Examination.....	5-26
5.2 Fuel Burnup.....	5-33

5.3	Iodine and Cesium Analysis of the Fuel Cladding	5-34
6.	SHIPPING AND STORAGE	6-1
6.1	Shipment from Shippingport to Expanded Core Facility	6-1
6.2	Handling, Disassembly of Selected Modules, and Storage at Expanded Core Facility	6-10
6.2.1	Water Removal at Expanded Core Facility.....	6-13
6.2.2	Shipment from Expanded Core Facility to INTEC.....	6-13
6.3	Storage at INTEC	6-17
6.4	Condition of SNF	6-31
6.5	Thermal Output	6-31
6.6	Liquid Content of Canister	6-31
7.	REFERENCES	7-1
	Appendix A—End-of-Life Fissile Data from the Production Irradiated Fuel Assay Gauge	A-1
	Appendix B—Results from ANL-E Destructive Examinations.....	B-1
	Appendix C—Scrap Storage Liner.....	C-1
	Appendix D—Rods in the Type C Storage Liners.....	D-1

FIGURES

2-1.	Conversion of Thorium-232 to uranium by neutron absorption and radioactive decay in a Light Water Breeder Reactor	2-2
2-2.	Light Water Breeder Reactor core in Shippingport Reactor Vessel	2-3
2-3.	Light Water Breeder Reactor cross-section module identification	2-4
3-1.	Movable fuel control.....	3-2
3-2.	Light Water Breeder Reactor Type IV Reflector Module rod and cell identification	3-4
3-3.	Type V Reflector Module.....	3-5
3-4.	Cross-sectional dimensions of the Light Water Breeder Reactor modules.....	3-6
3-5.	Axial schematic of a Type I Module.....	3-7
3-6.	Light Water Breeder Reactor movable seed module rod arrangement and cell identification	3-8
3-7.	Light Water Breeder Reactor Type I blanket module rod configuration and cell identification	3-9

3-8.	Axial schematic of the seed surrounded by a power-flattening blanket module	3-10
3-9.	Type II blanket module rod and cell identification.....	3-11
3-10.	Type III blanket module rod and cell identification	3-12
3-11.	Light Water Breeder Reactor seed fuel rods.....	3-22
3-12.	Light Water Breeder Reactor blanket fuel rods	3-24
3-13.	Light Water Breeder Reactor reflector fuel rods	3-26
4-1.	Light Water Breeder Reactor operational history, 1977	4-2
5-1.	Diagram of Light Water Breeder Reactor core, showing locations of Proof-of-Breeding modules and boundaries of Sixth-Core Sectors	5-2
5-2.	Location of proof-of-breeding rods in Seed Module I-1.....	5-12
5-3.	Location of proof-of-breeding rods in Seed Module II-3	5-13
5-4.	Location of proof-of-breeding rods in Seed Module III-1	5-14
5-5.	Location of proof-of-breeding rods in Seed Module III-2.....	5-15
5-6.	Location of proof-of-breeding rods in Blanket Module I-3	5-16
5-7.	Location of proof-of-breeding rods in Blanket Module II-2.....	5-17
5-8.	Location of proof-of-breeding rods in Blanket Module III-2	5-18
5-9.	Location of proof-of-breeding rods in Blanket Module III-6	5-19
5-10.	Location of proof-of-breeding rods in Reflector Module IV-4.....	5-20
5-11.	Location of proof-of-breeding (POB) rods in Reflector Module IV-9	5-21
5-12.	Location of proof-of-breeding rods in Reflector Module IV-3.....	5-22
5-13.	Location of proof-of-breeding rods in Reflector Module V-4.....	5-23
5-14.	Rod examination (REX) fuel rod locations.....	5-25
6-1.	Light Water Breeder Reactor seed module as received at the Expanded Core Facility.....	6-2
6-2.	Light Water Breeder Reactor blanket module as received at Expanded Core Facility.....	6-3
6-3.	Light Water Breeder Reactor reflector module as received at Expanded Core Facility	6-4
6-4.	Module holder for seed modules.....	6-5
6-5.	Module holder for blanket modules.....	6-6

6-6. Module holder for reflector modules	6-7
6-7. M-130 shipping container as modified for Light Water Breeder Reactor fuel shipments	6-8
6-8. M-130 irradiated fuel shipping system	6-9
6-9. Light Water Breeder Reactor fuel module grapple shown with seed module	6-11
6-10. Area of the Expanded Core Facility water pits used for Light Water Breeder Reactor program.....	6-12
6-11. LWBR Seed Stabilization Clamp	6-14
6-12. Light Water Breeder Reactor storage liner blowdown schematic	6-15
6-13. Light Water Breeder Reactor storage liner air circulation schematic	6-16
6-14. Typical Light Water Breeder Reactor fuel module storage liner.....	6-18
6-15. Section views of the dry well design for both unirradiated and irradiated Light Water Breeder Reactor fuel storage dry wells.....	6-19
6-16. Plat plan of the Light Water Breeder Reactor fuel storage facility.....	6-20
6-17. Occupied liner cells (in black) for reflector rod storage Liner 15681.....	6-24
6-18. Occupied liner cells (in black) for blanket rod storage Liner 15682	6-25
6-19. Occupied liner cells (in black) for reflector rod storage Liner 15683.....	6-26
6-20. Occupied liner cells (in black) for blanket rod storage Liner 15684	6-27
6-21. Occupied liner cells (in black) for blanket rod storage Liner 15685	6-28
6-22. Occupied liner cells (in black) for seed rod storage Liner 15686.....	6-29
6-23. Occupied liner cells (in black) for blanket rod storage Liner 15687	6-30
6-24. Decay heat as a function of cooling time for the hottest fully rodded seed, blanket, and reflector modules	6-34

TABLES

2-1. Average as-built Light Water Breeder Reactor fuel lattice characteristics.....	2-6
2-2. Peak local linear power rating burnup and fluence for each of Light Water Breeder Reactor fuel regions.....	2-7
3-1. Number of fuel rods by module and total number of fuel rods in Light Water Breeder Reactor core	3-6

3-2.	Masses of uranium isotopes in the seed modules and in the power flattening and standard portions of the blanket modules at beginning of life	3-13
3-3.	Neutron Poison Equivalence.....	3-15
3-4.	Average as-built Light Water Breeder Reactor pellet characteristics	3-16
3-5.	Light Water Breeder Reactor fuel pellet dimension	3-17
3-6.	Average as-built pellet density and void fraction	3-18
3-7.	Production specifications for pellets.....	3-18
3-8.	Grain size of Light Water Breeder Reactor fuel at end-of-life	3-19
3-9.	Light Water Breeder Reactor fuel rod dimensions	3-21
3-10.	Average as-built Light Water Breeder Reactor loading by module type.....	3-27
3-11.	Seed and blanket module initial thorium and uranium loadings.....	3-28
3-12.	Light Water Breeder Reactor fuel rod cladding material properties.....	3-29
3-13.	Requirements for Light Water Breeder Reactor tubing	3-30
3-14.	Ingot requirements for Light Water Breeder Reactor Zircaloy-4 tubing	3-38
4-1.	Summary of Light Water Breeder Reactor station performance	4-8
4-2.	Summary of Light Water Breeder Reactor operating conditions.....	4-9
4-3.	Timeline of events for the Light Water Breeder Reactor.....	4-10
5-1.	Modeled and measured end-of-life (EOL) isotopic content of Light Water Breeder Reactor fuel rods	5-3
5-2.	Summary of nondestructive examinations.....	5-6
5-3.	Fuel rod crud characterization	5-11
5-4.	Calibration rod isotopic loadings.....	5-24
5-5.	Destructive examinations.....	5-27
5-6.	Operating characteristics of the 12 Light Water Breeder Reactor destructive examination fuel rods at end-of-life	5-29
5-7.	Light Water Breeder Reactor fuel rod fission gas release at end-of-life.....	5-30
5-8.	Fission gases (Kr + Xe) released during processing of Light Water Breeder Reactor rods	5-31

5-9. Isotopic results from Argonne National Laboratory-East destructive examination of 17 Light Water Breeder Reactor rods.	5-32
5-10. Comparison of measured and calculated fuel depletion and burnup	5-34
5-11. Concentration of I-129 in Light Water Breeder Reactor fuel rod cladding and fuel pellets.....	5-35
5-12. Concentration of Cs-137 in Light Water Breeder Reactor fuel rod cladding and fuel pellets.....	5-35
6-1. Types and contents of Light Water Breeder Reactor storage liners.....	6-21
6-2. Number and type of fuel rods in each liner.....	6-23
6-3. Data from Part C fuel receipt criteria.....	6-32
6-4. Estimated decay heat values for Light Water Breeder Reactor core modules in the year 2005 ...	6-35

ACRONYMS AND ABBREVIATIONS

ANL-E	Argonne National Laboratory-East
ANL-W	Argonne National Laboratory-West
APS	Atomic Power Station
AWBA	Advanced Water Breeder Applications
DOE	U.S. Department of Energy
ECF	Expended Core Facility
EFPH	effective full power hours
EOL	end-of-life
INEEL	Idaho National Engineering and Environmental Laboratory
INTEC	Idaho Nuclear Technology and Engineering Center
LWBR	Light Water Breeder Reactor
NPE	neutron poison equivalence
NRF	Naval Reactor Facility
PIFAG	Production Irradiated Fuel Assay Gauge
REX	Rod Examination

Fuel Summary Report: Shippingport Light Water Breeder Reactor

1. INTRODUCTION

The Shippingport Light Water Breeder Reactor (LWBR) was a water-cooled, U-233/Th-232 cycle breeder reactor developed by the Pittsburgh Naval Reactors to improve use of the nation's nuclear fuel resources in light water reactors. The LWBR was operated at Shippingport Atomic Power Station (APS), which was a U.S. Department of Energy (DOE) (formerly Atomic Energy Commission)-owned reactor plant. Shippingport APS was the first large-scale, central-station nuclear power plant in the United States and the first plant of such size in the world operated solely to produce electric power.

This report compiles and summarizes information about the LWBR core and its present configuration. Information presented here was derived or extracted from technical reports, shipping documentation, laboratory results, letters, and other documentation. This report is intended to provide an overview of the existing data and point to reference sources to obtain additional detail. The report is not intended for direct use in design applications. For design applications, the original source documentation must be used.

Shippingport's program was started in 1953 to confirm the practical application of nuclear power for large-scale electric power generation. Subsequent to development and successful operation of the pressurized water reactor, the Atomic Energy Commission in 1965 undertook a research and development program to design and build an LWBR core for operation in the Shippingport Station. In 1976, with fabrication of the Shippingport LWBR core nearing completion, the Energy Research and Development Administration, now DOE, established the Advanced Water Breeder Applications (AWBA) program to develop and disseminate technical information that would assist the U.S. industry in evaluating the LWBR concept for commercial-scale applications. The AWBA program was conducted under the technical direction of the Office of the Deputy Assistant Secretary for Naval Reactors of DOE (Beaudoin 1987, WAPD-TM-1315, p. iii).

The Shippingport LWBR operated from 1977 to 1982 at the APS. During the 5 years of operation, the LWBR generated more than 29,000 effective full power hours (EFPH) of energy.

After final shutdown, the 39 core modules of the LWBR were shipped to the Expended Core Facility (ECF) at the Naval Reactors Facility (NRF) at the Idaho National Engineering and Environmental Laboratory (INEEL). At ECF, 12 of the 39 modules were dismantled, and about 1000 rods were removed from the modules for proof-of-breeding and fuel performance testing. Some of the removed rods were kept at ECF, some were sent to Argonne National Laboratory-West (ANL-W) in Idaho and some to ANL-East (ANL-E) in Chicago for a variety of physical, chemical, and radiological examinations. All rods and rod sections remaining after the experiments were shipped back to the ECF, where modules and loose rods were repackaged in liners for dry storage. In a series of shipments, the liners were transported from ECF to the Idaho Nuclear Technology and Engineering Center (INTEC), formerly the Idaho Chemical Processing Plant. The 47 liners that contain the fully rodded and partially derodded core modules, the loose rods, and the rod scraps are now stored in underground dry wells at CPP-749.

2. REACTOR INFORMATION

2.1 Reactor

2.1.1 Location and Ownership

The Shippingport LWBR was installed in the Shippingport APS on the south bank of the Ohio River in Shippingport Borough, Beaver County, Pennsylvania, about 30 miles northwest of Pittsburgh.

The LWBR was developed and designed by the Bettis Atomic Power Laboratory, which was operated by Westinghouse Electric Corporation. Design and development occurred under the technical direction of the Division of Naval Reactors of DOE (addendum to Sarber 1983, WAPD-TM-1455, p. 2). The Shippingport LWBR was operated by Duquesne Light Company (Sarber 1983, WAPD-TM-1455, p. 2).

Pressurized water reactors were originally operated at Shippingport; then the LWBR was designed and constructed to fit into the existing reactor core vessel. The LWBR is the only core to operate at Shippingport APS that used highly enriched U-233 oxides and was designed to breed, and is distinguished from the other cores from the same location on that basis.

2.1.2 Reactor Type/Design

The LWBR was designed as a pressurized, light-water moderated and cooled thermal reactor that used the thorium/uranium-233 fuel cycle. Figure 2-1 presents a schematic of the breeding decay series showing Th-232 conversion to uranium. The LWBR core was developed for reactor operation within the constraints of the existing Shippingport reactor. Nuclear design of the LWBR core used a seed-blanket concept similar to that successfully applied to the first two pressurized water reactor cores operated at Shippingport, but with reactivity control provided by core geometry changes (movable fuel) instead of poison rods (Campbell and Giovengo 1987, WAPD-TM-1387, p. 4). Figure 2-2 shows the arrangement of the core components in the Shippingport reactor vessel. Figure 2-3 shows a plan cross section of the LWBR core installed in the Shippingport pressurized water reactor vessel. The interior modules were designed so that they could be used directly in a large (1,000 MW(e)) LWBR core. The design simulated a large LWBR core's interior and permitted net breeding in the entire core (Atherton 1987, WAPD-TM-1600, pp. 15, 22).

The LWBR core was designed to minimize parasitic neutron absorption in core and structural materials. Some of the core design features that contributed to improved neutron economy in the LWBR were:

1. Use of movable fuel to control core reactivity, rather than conventional poison control rods, soluble poison, or burnable poison.
2. Use of peripheral radial and axial thoria reflector blanket regions to reduce neutron leakage from the core.
3. Use of zircaloy with a low hafnium content (<40 ppm) for fuel rod cladding and for all structures in the active fuel region except the fuel rod support grids.
4. Use of stainless steel (AM-350) rather than Inconel for fuel rod support grids (Hecker 1979, WAPD-TM-1326).

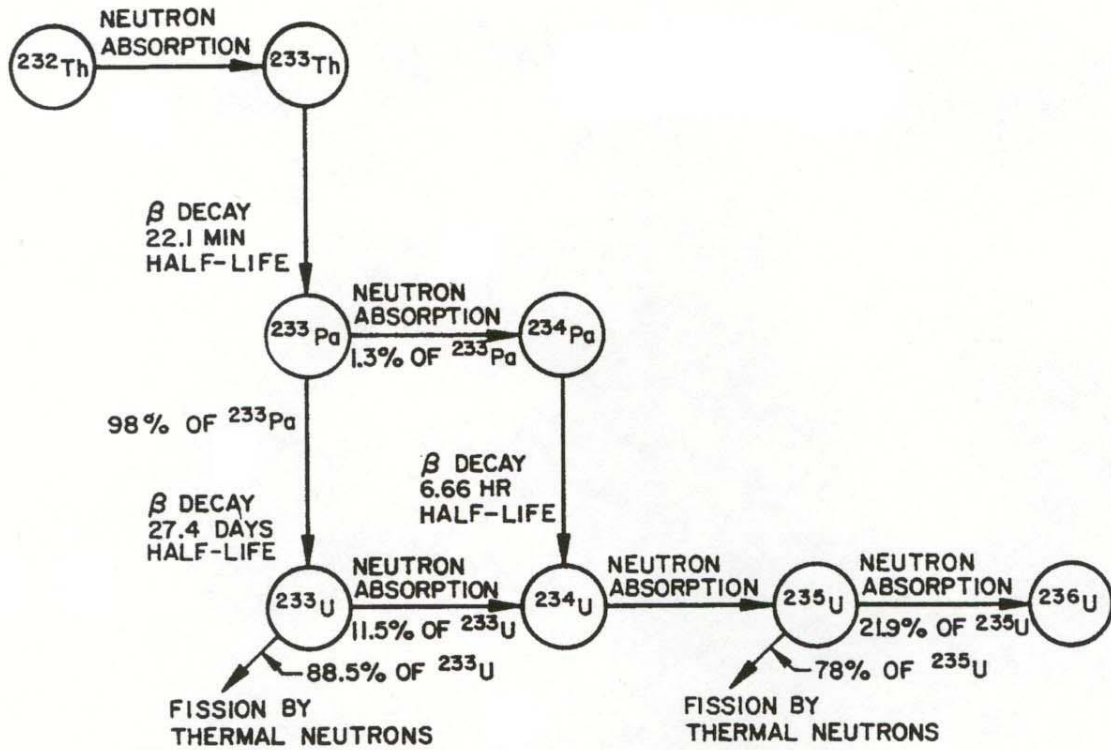

Figure 2-1. Conversion of Thorium-232 to uranium by neutron absorption and radioactive decay in a Light Water Breeder Reactor (Campbell and Giovenco 1987, WAPD-TM-1387).

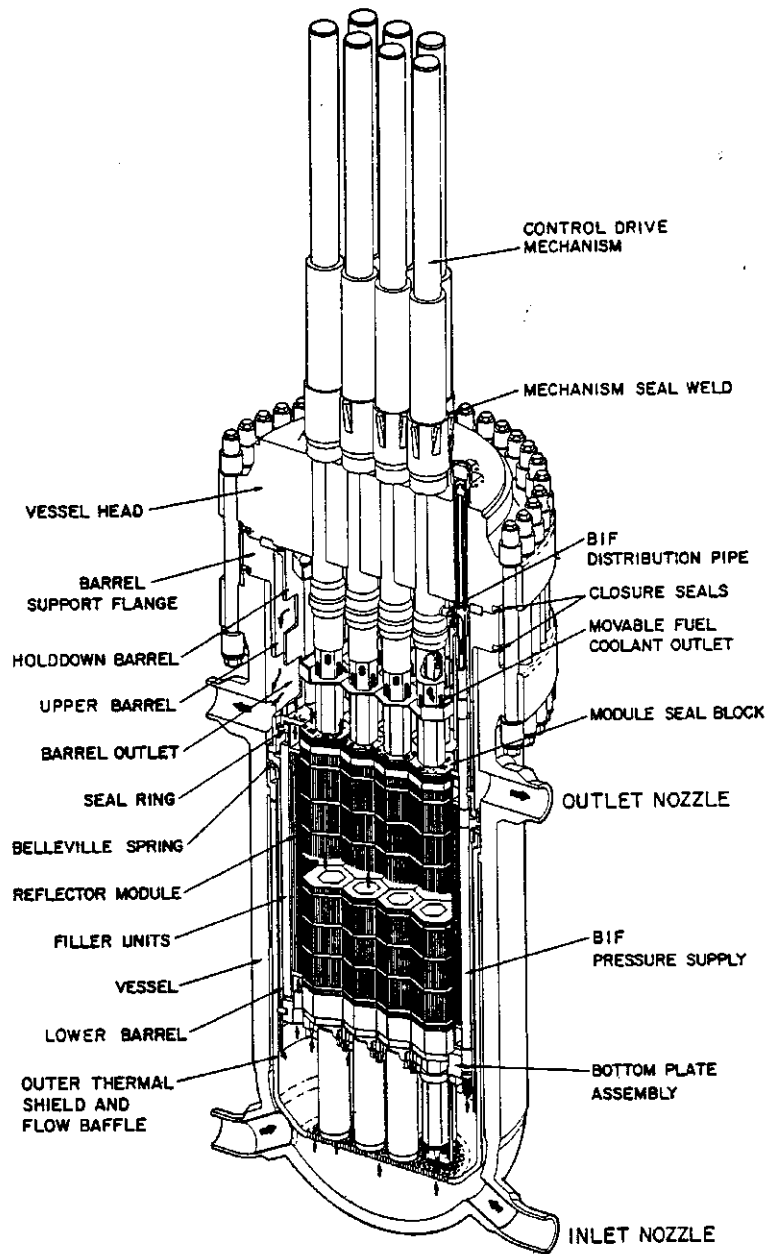

Figure 2-2. Light Water Breeder Reactor core in Shippingport Reactor Vessel (Connors et al. 1979, WAPD-TM-1208).

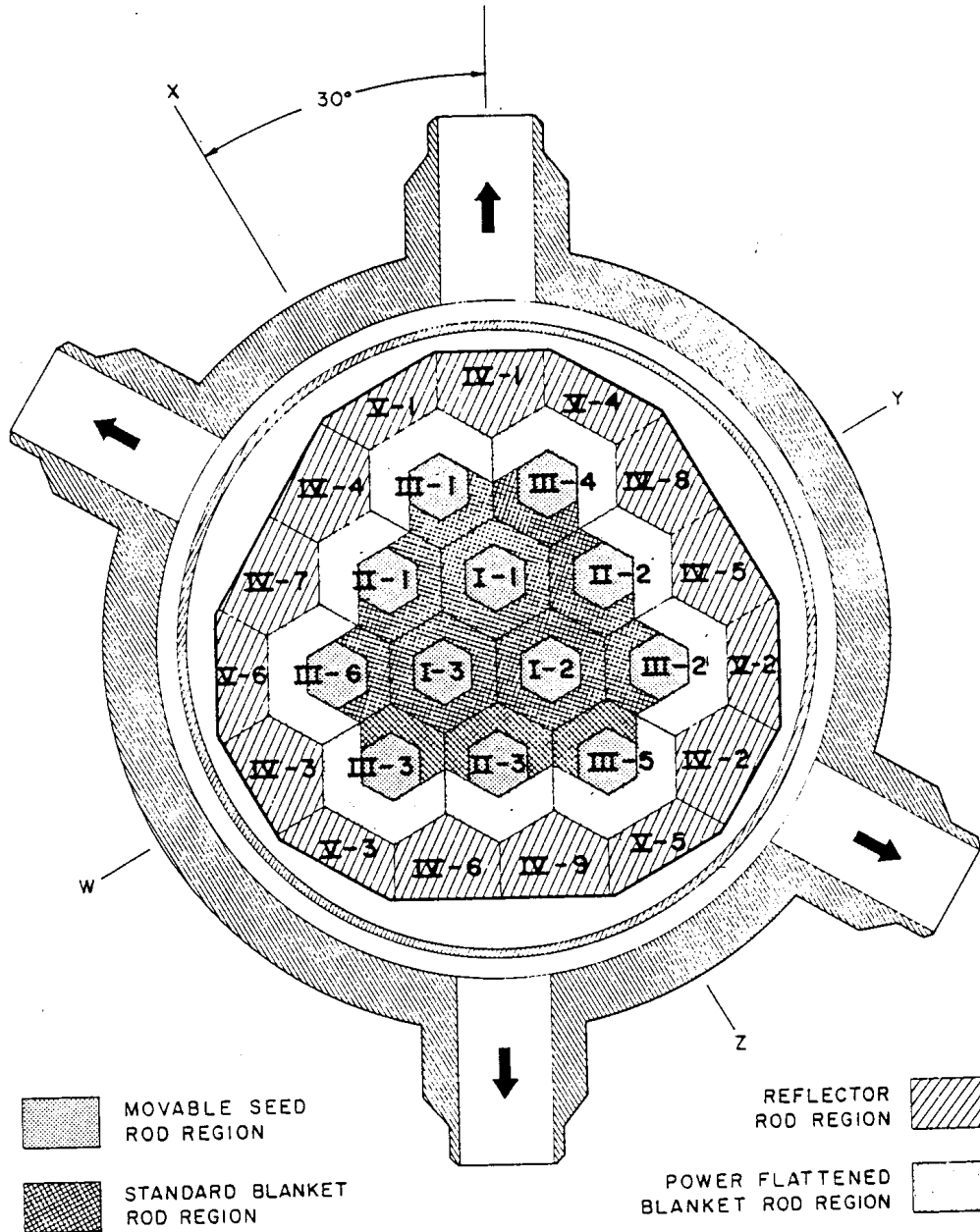

Figure 2-3. Light Water Breeder Reactor cross-section module identification (Sarber 1976, WAPD-TM-1336).

The four primary fuel regions (seed, standard blanket, power-flattening blanket, and reflector blanket) were each optimized to maximize neutron absorption in thorium and to minimize neutron loss (Campbell and Giovenco 1987, WAPD-TM-1387, p. 4). The three central fuel modules of the core are identical and symmetrical and were designed for use in a large central station reactor plant. The three Type I central seed and blanket modules were surrounded by nine Type II or Type III module groups, each consisting of a movable seed and a stationary blanket. The Type II and Type III blanket modules consisted of a standard and a power-flattening component. The power-flattening blankets were slightly thicker and contained slightly more U-233 than the standard blanket regions of the inner modules. Use of this more highly loaded power-flattening blanket region produced a relatively uniform power distribution

within the interior of the core, and thereby better simulating the environment of a typical large core. The power flattening increased the U-233 loading required for the small core used in Shippingport (Freeman 1978, WAPD-TM-1314, p. 4).

The seed with highly enriched UO_2 provided neutrons efficiently. The fertile fuel in the blanket absorbed excess neutrons efficiently and produced fissile fuel. Both the seed and blanket were optimized to maximize neutron production and minimize neutron loss (Hecker and Freeman 1981, WAPD-TM-1409). Reactivity in a seed-blanket reactor is dominated by the seed; thus changes in seed geometry caused reactivity variations. The central movable seed concept for fuel reactivity control eliminated the need for control poisons (Hecker 1979, WAPD-TM-1326, p. 3).

Water entered the vessel through four inlet nozzles at the bottom of the reactor vessel. The water was heated as it flowed upward through the modules, past the fuel elements, and exited the vessel through the outlet nozzles after a single pass through the core (Atherton 1987, WAPD-TM-1600, p.10).

2.2 Reactor Parameters

2.2.1 Reactor Physical Dimensions

The reactor vessel at Shippingport was approximately 33 ft high with an inner diameter of 9 ft and a nominal wall thickness of 8-7/8 in. (Massimino and Williams 1983, WAPD-TM-1342). Within the vessel was a core barrel, a long cylinder that locates fuel assemblies within the vessel. The core barrel was supported in the vessel by a large doughnut-shaped weldment called the support flange that rested on top of the vessel. The support flange also served as the entrance point of various types of core instrumentation and safety injection piping. The support flange was clamped in position by the 50-inch-thick steel closure head using 6-inch diameter studs, which were installed in mating bolting flanges of the closure head and reactor vessel (Massimino and Williams 1983, WAPD-TM-1342, p. 2).

2.2.2 Core Grid Locations

The axial fuel rod support system for the LWBR fuel consisted of hexagonal grids made of precision-stamped AM-350 stainless steel sheet metal components (Atherton 1987, WAPD-TM-1600). The grids were designed to maintain the tight rod-to-rod spacing (about 0.06 in.) necessary to achieve a high fuel-to-water ratio, facilitate the production of neutrons, and achieve fuel economy. There were nine grids in the seed assembly and eight in the blanket assembly (Hecker 1979, WAPD-TM-1326). The grid volume per fuel rod data is given in Table 2-1, and accounts for only the number of grids present over the fuel height and only the fraction per level actually present in the fuel lattice. Remaining grid volumes are contained in metal-water regions exterior to the fuel lattice regions. **Note:** Table 2-1 lists 6, 6.5, or 7.5 for the number of grids in the fuel height. The table shows fewer grids in the fuel height because one grid is entirely above the fuel and half of a grid is below the fuel in each assembly (Hecker 1979, WAPD-TM-1326).

2.2.3 Maximum Design Parameters

Data for peak local linear power rating and fluence for each of the four LWBR fuel regions (seed, power-flattening and standard blanket, and reflector regions) are presented in Table 2-2.

Table 2-1. Average as-built Light Water Breeder Reactor fuel lattice characteristics (Hecker 1979, WAPD-TM-1326, Table II-1).

	<u>Seed</u>	<u>Standard Blanket</u>	<u>Power Flattening Blanket</u>	<u>Reflector Blanket</u>
Rod center - center spacing (in.)	0.3686	0.6304	0.6304	0.9005
Rod outer diameter (in.)	0.3063	0.5717	0.5274	0.8323
Rod surface-surface spacing (in.)	0.0623	0.0587	0.1030	0.0682
Clad thickness (in.)	0.02217	0.02808	0.02642	0.0419
Clad thickness/diameter ratio	0.072	0.049	0.050	0.050
Number of grid levels	9	8	8	6
Number of grids in fuel height	7.5	6.5	6.5	6
Grid fraction/level, in fuel lattice	0.846	0.79	0.79	0.80
Grid volume/fuel rod (in. ³)*	0.130	0.211	0.211	0.422
Metal/water volume ratio†	1.740	2.981	1.764	3.486
Total number of fuel rods	7428	3234	3581	3047
Number of flux-well rods	None	3	4	1
Total fissile loading (kg)	198.6	116.3	186.1	None
Total Th-232 loading (kg)	5206.5	9487.1	8788.3	18574.2

*Volume in fuel rod lattice based on number of grids in fuel height and the grid fraction per level in the fuel lattice.

†Under nominal hot conditions and with grid volume per fuel rod homogenized throughout the fuel regions.

Table 2-2. Peak local linear power rating burnup and fluence for each of Light Water Breeder Reactor fuel regions (Campbell and Giovengo 1987, WAPD-TM-1387, Table 1).

Parameter	Fuel Region			
	Seed	Standard Blanket	Power Flattening Blanket	Reflector
<u>Peak Linear Power (kw/ft)</u>				
Best Estimate	6.7	8.9	8.7	3.6
Design	8.8	11.7	11.5	4.7
<u>Peak Depletion (10^{20} f/cc)</u>				
Best Estimate at 18,000 EFPH	8.3	3.4	3.9	0.5
Best Estimate at 29,047 EFPH	11.4	5.3	5.7	1.0
Design at 18,000 EFPH	9.7	4.3	4.6	0.6
Design at 29,047 EFPH	13.4	6.7	7.0	1.3
<u>Peak Burnup (MWD/MTM)</u>				
Best Estimate at 18,000 EFPH	38,900	15,200	17,000	2,400
Best Estimate at 29,047 EFPH	53,400	23,200	25,200	4,500
Design at 18,000 EFPH	45,300	19,000	20,500	2,800
Design at 29,047 EFPH	62,500	29,600	30,800	5,600
<u>Maximum Rod - Average Depletion (10^{20} f/cc)</u>				
Best Estimate at 18,000 EFPH	4.4	2.0	2.2	0.3
Best Estimate at 29,047 EFPH	6.4	3.0	3.3	0.5
Design at 18,000 EFPH	4.7	2.2	2.5	0.3
Design at 29,047 EFPH	7.0	3.5	3.8	0.6
<u>Maximum Rod - Average Burnup (MWD/MTM)</u>				
Best Estimate at 18,000 EFPH	20,500	8,700	9,800	1,200
Best Estimate at 29,047 EFPH	29,800	13,200	14,700	2,200
Design at 18,000 EFPH	22,100	9,700	10,900	1,300
Design at 29,047 EFPH	32,900	15,500	16,800	2,700
<u>Peak Fluence (10^{20} n/cm², >1 Mev)</u>				
Best Estimate at 18,000 EFPH	66.3	48.4	38.5	17.7
Best Estimate at 29,047 EFPH	96.5	73.8	58.6	27.8
Design at 18,000 EFPH	70.3	53.8	44.0	20.0
Design at 29,047 EFPH	104.7	84.0	69.0	32.1

3. FUEL INFORMATION

The nuclear parameter most important to breeding is the neutron regeneration factor (η), which is the average number of neutrons produced in fission for each neutron absorbed in fissile fuel. To achieve breeding, this ratio must be greater than 2.0. Only three nuclear fuel materials are capable of fissioning on a practical basis for the production of electrical energy (U-235, Pu-239, and U-233). There was evidence from earlier work that the neutron regeneration factors for U-235 and Pu-239 were inadequate for light water reactors, but the η for U-233 suggested U-233 had greater potential for breeding, particularly in a reactor with low water content (achieved by close fuel rod spacing) (Hecker 1989, WAPD-TM-1409, pp. 3-6). Thus, U-233 was used in the LWBR.

The LWBR core had a seed-blanket configuration consisting of 12 movable-fuel seed assemblies each surrounded by a stationary blanket assembly. The seed-blanket assemblies were designated as Types I, II, or III based on the nature of the blanket assemblies surrounding the seeds (see Figure 2-3), and the Type I, II and III assemblies were surrounded by Type IV and V reflector assemblies.

Fabrication was completed between 1976 and 1977, and the LWBR core began operating in the fall of 1977 (DeGeorge and Goldberg 1986, WAPD-TM-1278, p. iii). Approximately 24,000 fuel rods were manufactured from which 17,288 were assembled into the LWBR core (DeGeorge and Goldberg 1986, WAPD-TM-1278, p. I-1).

3.1 Module Information

The LWBR core consisted of an array of seed and blanket modules surrounded by an outer reflector region (see Figure 2-3). The three central (Type I) seed-blanket modules were designed insofar as practical to represent a configuration that could be used in a large central station reactor plant. Core reactivity control was achieved by moving the seed up and down within the stationary blanket assemblies using individual control drive mechanisms.

The seeds were symmetrical hexagons. Surrounding the three central seeds were symmetrical hexagonal Type I blanket modules. The rest of the seeds were surrounded by Type II and Type III blanket modules, which consisted of standard and power-flattening portions (see Figure 2-3).

Changing the axial position of the seed relative to the blankets changed the relative amounts of neutron absorptions in the fissile (U-233) and fertile (Th-232) fuel materials. To shut the reactor down, the seed assemblies were positioned 60 in. below the bottoms of the blanket assemblies as shown in Figure 3-1. To start up the reactor, the seed assemblies were raised, bringing the U-233 bearing parts of the fuel closer together. The control scheme was analogous in concept and operation to that of conventional poison rod control where negative reactivity addition and core shutdown are achieved by lowering the control elements, and positive reactivity addition is achieved by raising the control elements (Sarber 1976, WAPD-TM-1336, p. 6).

There were four regions of the core as shown in Figure 2-3: seed, standard blanket around the core center, power-flattening blanket around the outside of the central core, and the reflector region around the core perimeter. Each module was loaded with hundreds of rods.

Each standard blanket module (Type I) was a symmetrical hexagon with a movable seed module in its center. Each power-flattening blanket module was an asymmetrical hexagon with a movable seed in its center, a standard component toward the core interior, and a power-flattening component toward the outer core. The power-flattening blanket modules were referred to as either Type II or Type III depending on the shape. Type II modules contained hexagonal blankets that had two power-flattening sides; Type III blankets were hexagons with three power-flattening sides. Power-flattening sides were wider than the

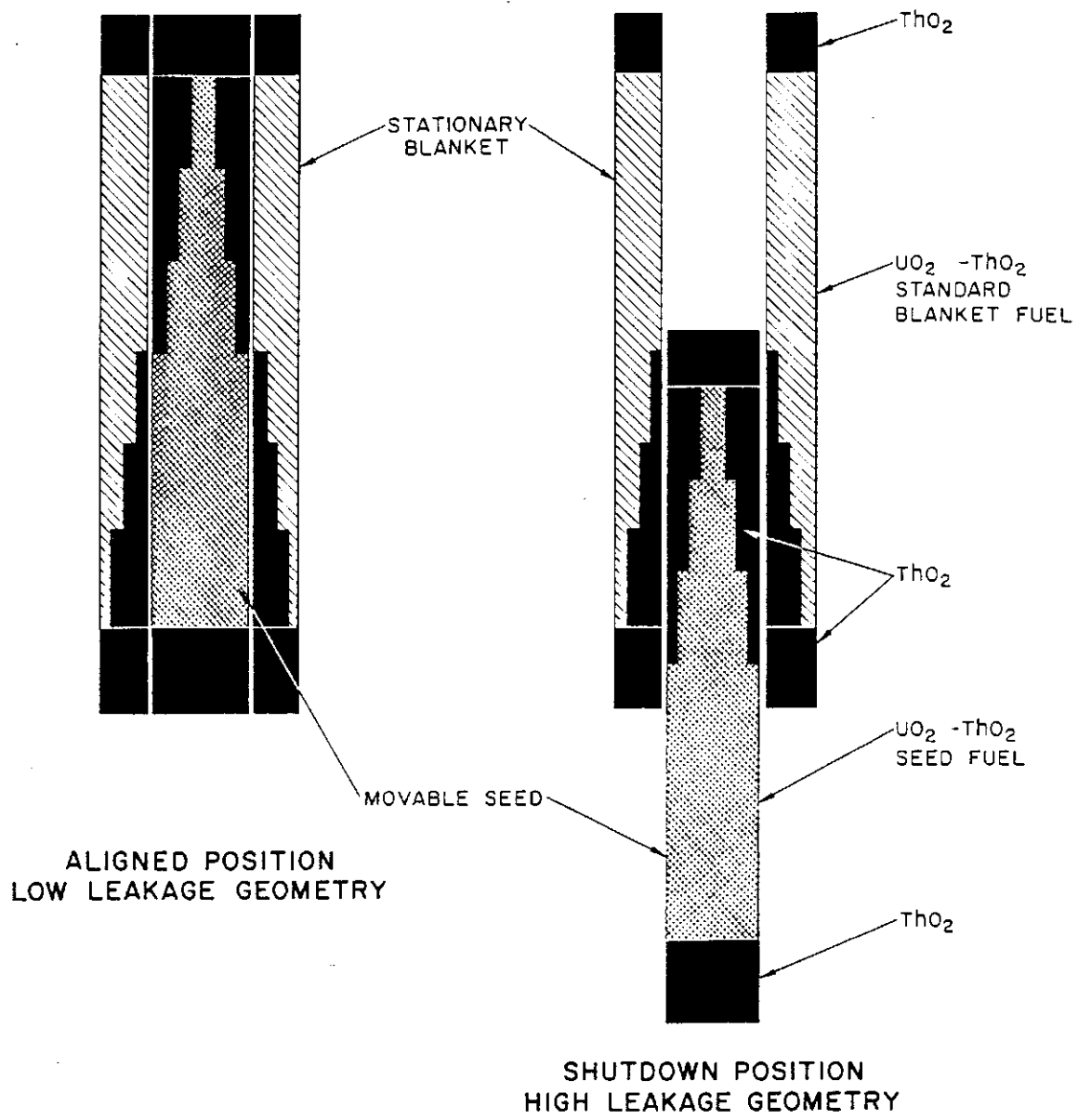

Figure 3-1. Movable fuel control (Sarber 1976, WAPD-TM-1336, Figure II-2).

standard sides, but the rods in the power-flattening blankets were smaller in diameter and higher in U-233 than rods in the standard blankets (Hecker 1979, WAPD-TM-1326). The reflector modules were either five-sided Type IV reflectors (Figure 3-2) or four-sided Type V reflectors (Figure 3-3). Surrounding the reflector modules were 15 stainless steel, nonfuel filler units whose purpose was to limit core flow leakage by filling the space between the reflector modules and the core vessel (Hecker 1979, WAPD-TM-1326, p. 4). Cross-sectional dimensions of the modules are presented in Figure 3-4.

In all, there were 39 modules in the LWBR core (12 seeds, 3 Type I blankets, 3 Type II blankets, 6 Type III blankets, 9 Type IV reflectors, and 6 Type V reflectors), with a total of 17,288 rods. The number of rods in each fully rodded module is listed in Table 3-1. The seed and blanket rods contained stacked ceramic binary ($\text{UO}_2\text{-ThO}_2$) fuel pellets. Binary stack lengths and uranium concentrations varied axially and radially within seed and blanket regions to maximize efficiency. The reflector rods contained no binary fuel, only thorium pellets.

Each fuel module contained a lattice of fuel rods arranged on a triangular pitch. The fuel rods were supported vertically in the fuel modules by the module baseplates and laterally by the grid support system. Figure 3-5 is a schematic axial cross-section of a seed/standard blanket configuration showing the highly enriched fuel in the central seed surrounded by lower-enriched fuel of diminishing binary stack lengths outside. Figure 3-6 depicts how the rods are configured radially within the seed module, and Figure 3-7 depicts the radial configuration of the rods in the standard blanket module. Figure 3-8 is a schematic of the axial cross-section of a seed and power-flattening blanket regions. Figures 3-9 and 3-10 depict the rod arrangement for the Type II and III power-flattening blankets, respectively. The standard portions of the Type II and Type III blanket modules (i.e., the uncolored portions in Figures 3-9 and 3-10) were loaded like the Type I blankets. The tops and bottoms of the fuel rods in the seed and blanket modules were stacked with fertile material in the form of ThO_2 fuel pellets.

To enhance breeding performance, the standard blanket region had a high metal-to-water ratio of 2.98. The power-flattening blanket fuel region had a lower metal-to-water ratio of about 1.76 (see Table 2-1) and a higher UO_2 concentration than the standard blanket. The power-flattening blanket was located on the outer periphery of the nine seed-blanket assemblies surrounding the three center seed-blanket assemblies. As a result, the overall radial core power distribution was flattened (Gorscak, Campbell, and Clayton 1987, WAPD-TM-1605, p. 5).

There were 9, 8, and 6 grid levels per each seed, blanket, and reflector module, respectively. Approximately half the fuel rods in each module were fixed to the top of the module, and the other half were fixed to the bottom of the module (Gorscak, Campbell, and Clayton 1987, WAPD-TM-1605, p. 8).

3.2 Fuel Information

The LWBR core was fueled with Th-232 and U-233, zoned axially and radially to maximize neutron economy (Hecker 1979, WAPD-TM-1326, p. 6+). The combination of radial and axial fuel zones served the dual purpose of achieving an acceptable peak-to-average power ratio and providing adequate movable fuel reactivity worths. Seed and blanket assemblies contained both fissile U-233 and fertile Th-232 at beginning of life, while the reflector fuel modules contained only thorium (as-built). The mass of each uranium isotope in the seed modules and the standard and power-flattening portions of the blanket modules is shown in Table 3-2.

The thorium-based fuel system had many operating advantages over the uranium system with some fabrication disadvantages. Fabrication difficulties of importance to design included uranium homogeneity, which is difficult to obtain in a single fire process; attainment of high density because of thorium's high melting temperature; and reduced diffusion coefficients at normal sintering temperature. Attainment of

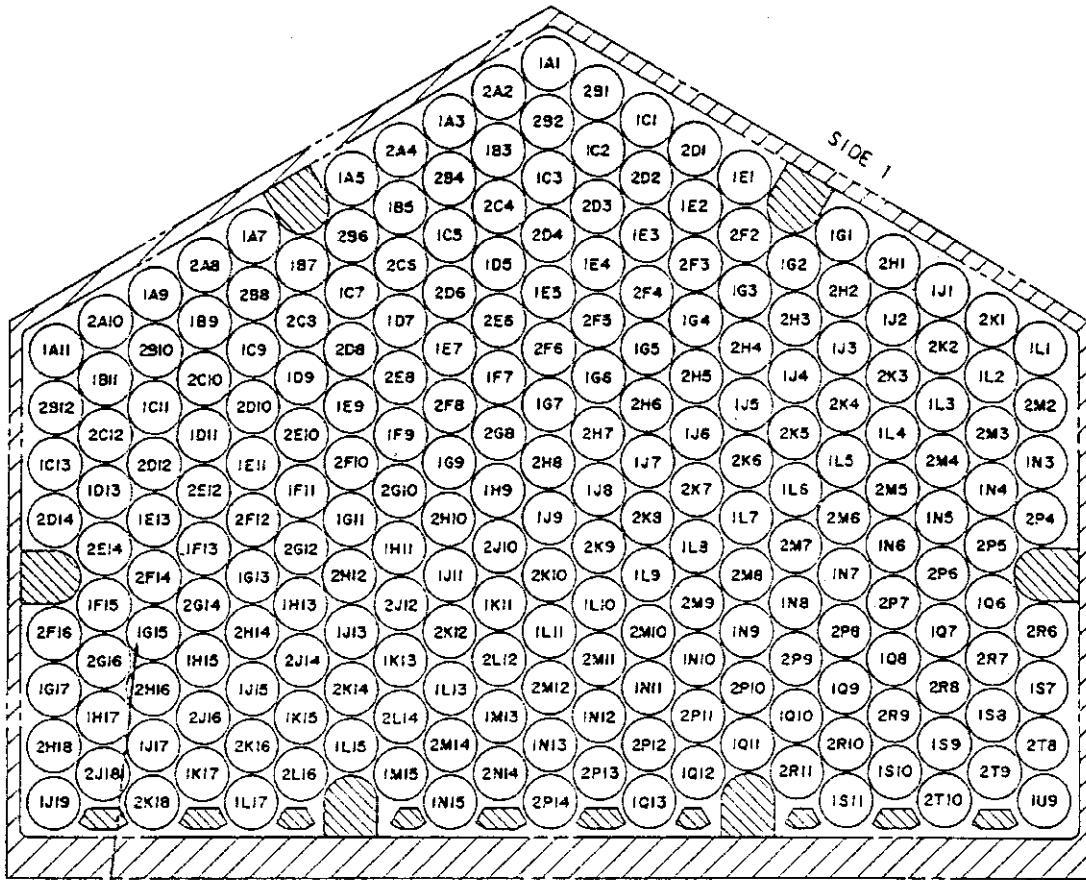

ROD LOCATION 1G15 TO BE OCCUPIED
BY FLUX WELL IN MODULE IV-7

IDENTIFICATION LEGEND
EXAMPLE:

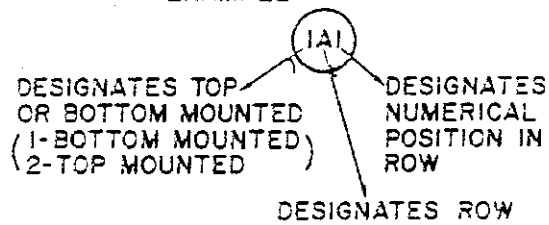

228 RODS (113 TOP MOUNTED)
.832 DIA.
.900 PITCH

Figure 3-2. Light Water Breeder Reactor Type IV Reflector Module rod and cell identification (Gorscak, Campbell, and Clayton 1987, WAPD-TM-1605, Figure A1-5).

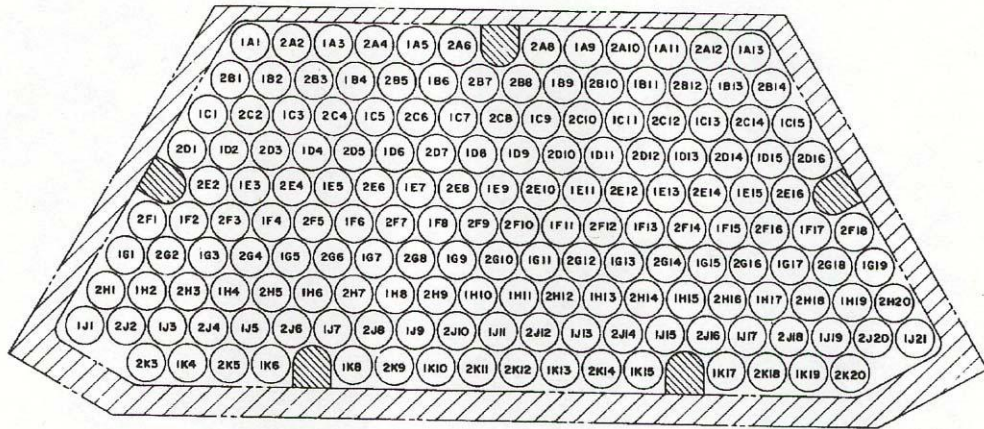

IDENTIFICATION LEGEND
EXAMPLE:

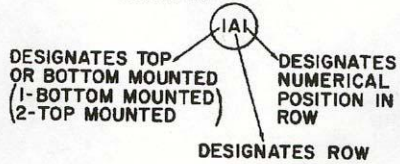

166 RODS (84 TOP MOUNTED)
.832 DIA.
.900 PITCH

Figure 3-3. Type V Reflector Module (blackened dots represent the rods removed from RV-4 for proof-of-breeding tests, from Schick et al. 1987, WAPD-TM-1612, Figure V-13).

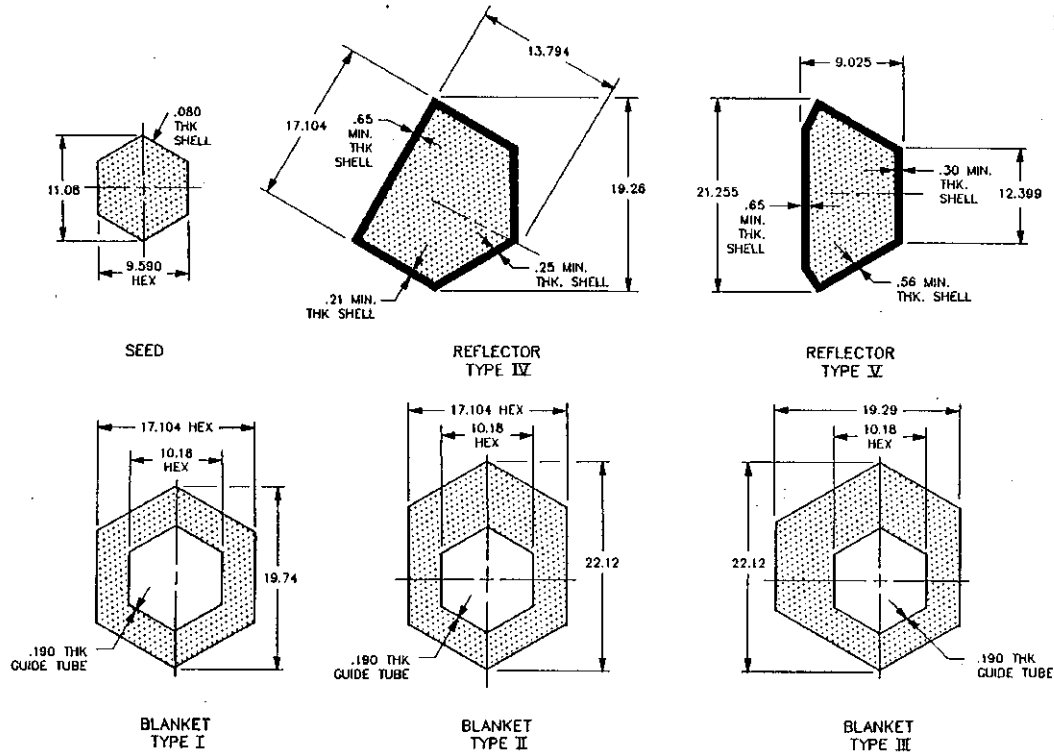
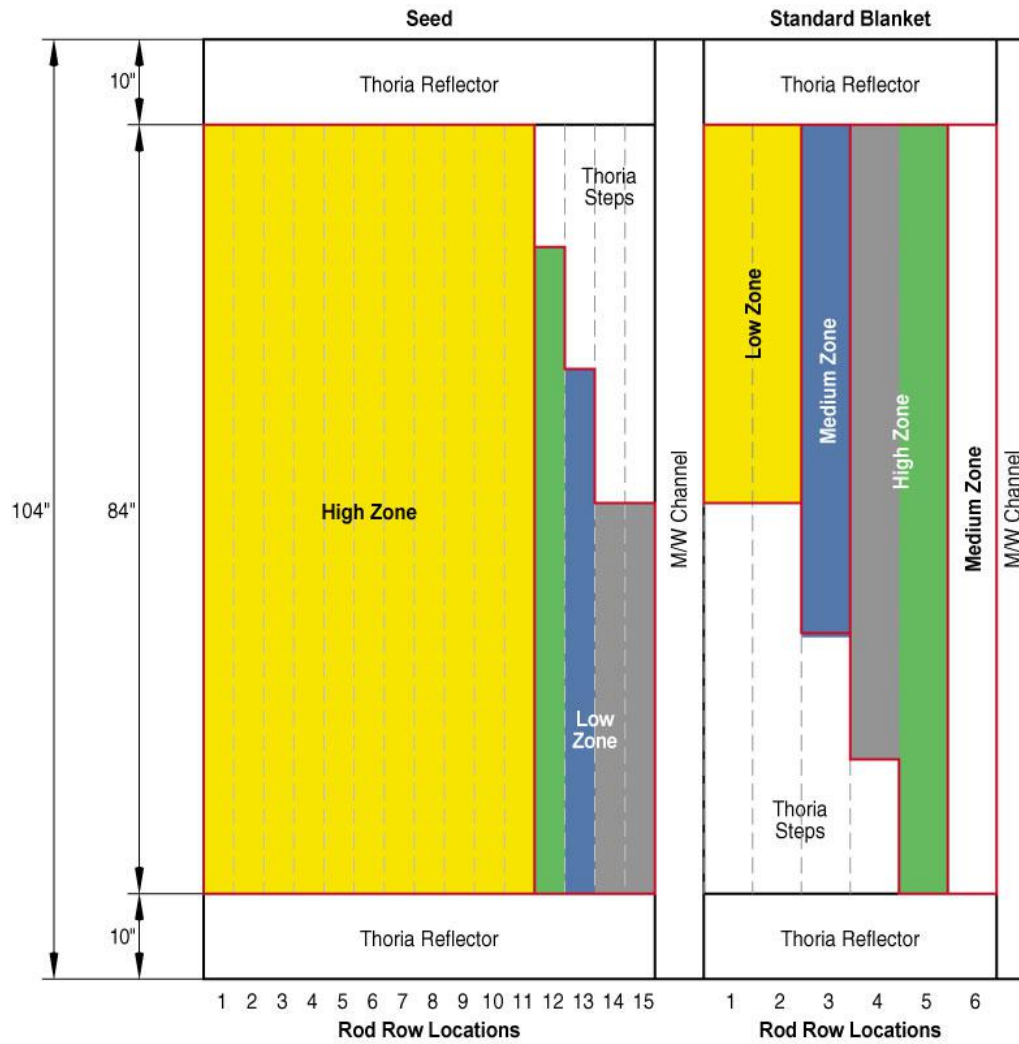

Figure 3-4. Cross-sectional dimensions of the Light Water Breeder Reactor modules (Greenberger and Miller 1987, WAPD-TM-1608, Figure 24).

Table 3-1. Number of fuel rods by module and total number of fuel rods in Light Water Breeder Reactor core.





Module Type	Number of Rods per Module	Number of Modules per Core	Total Number of Rod Locations per Core
Seed	619	12	7,428
Type I blanket	444	3	1,332
Type II standard blanket	261		783
Type II power-flattening blanket	303	3	909
Type III standard blanket	187		1,122
Type III power-flattening blanket	446	6	2,676
Type IV reflector	228	9	2,052
Type V reflector	166	6	996
Total		39	17,304 ^a

a. The actual core used 16 rod locations for flux wells, so the actual core was loaded with a total of 17,288 rods.

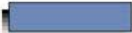

Y98 0400

Figure 3-5. Axial schematic of a Type I Module (modified from Hecker 1979, WAPD-TM-1326, Figure II-4).

	Rod Type ¹	Binary Stack Length	Fissile Concentration (U-fissile wt %) ²	Theoretical Density (g/cm ³) ²	Mass Initial Fissile (g)/Rod ³	Number of Rods/Module
	05, 06	84"	5.195	10.042	34.57	331
	04	70"	4.327	10.035	23.92	66
	03	56"	4.327	10.035	19.14	72
	01, 02, 07, 08	42"	4.327	10.035	14.33	150

619

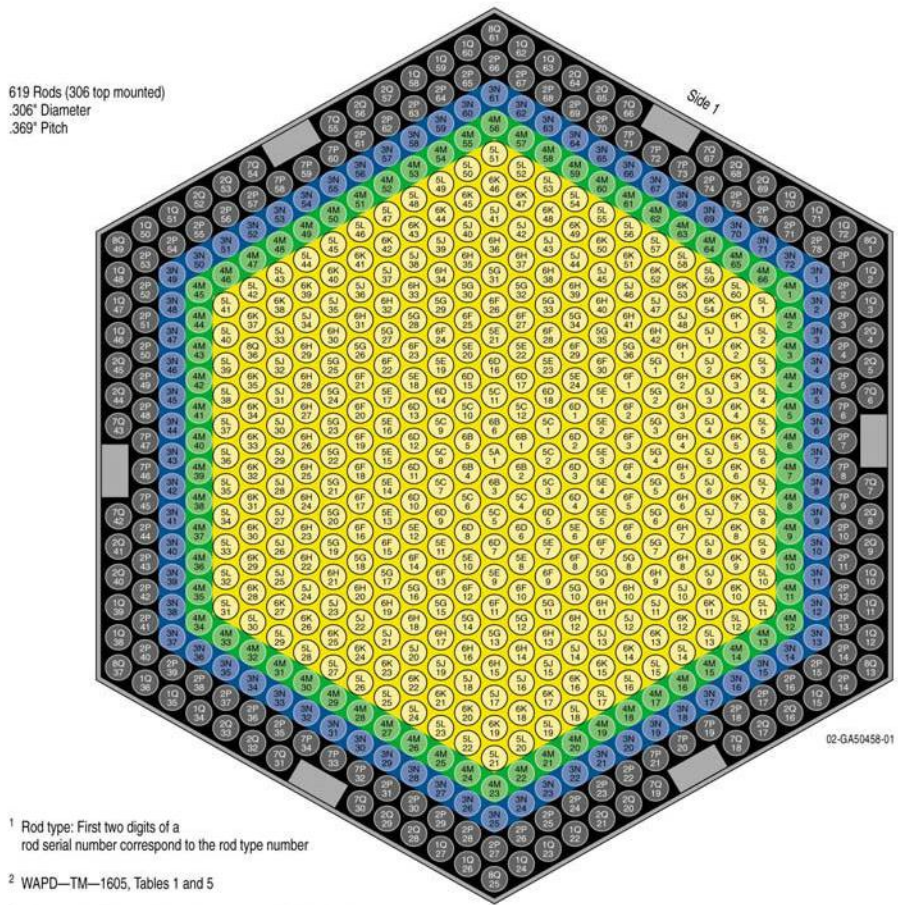





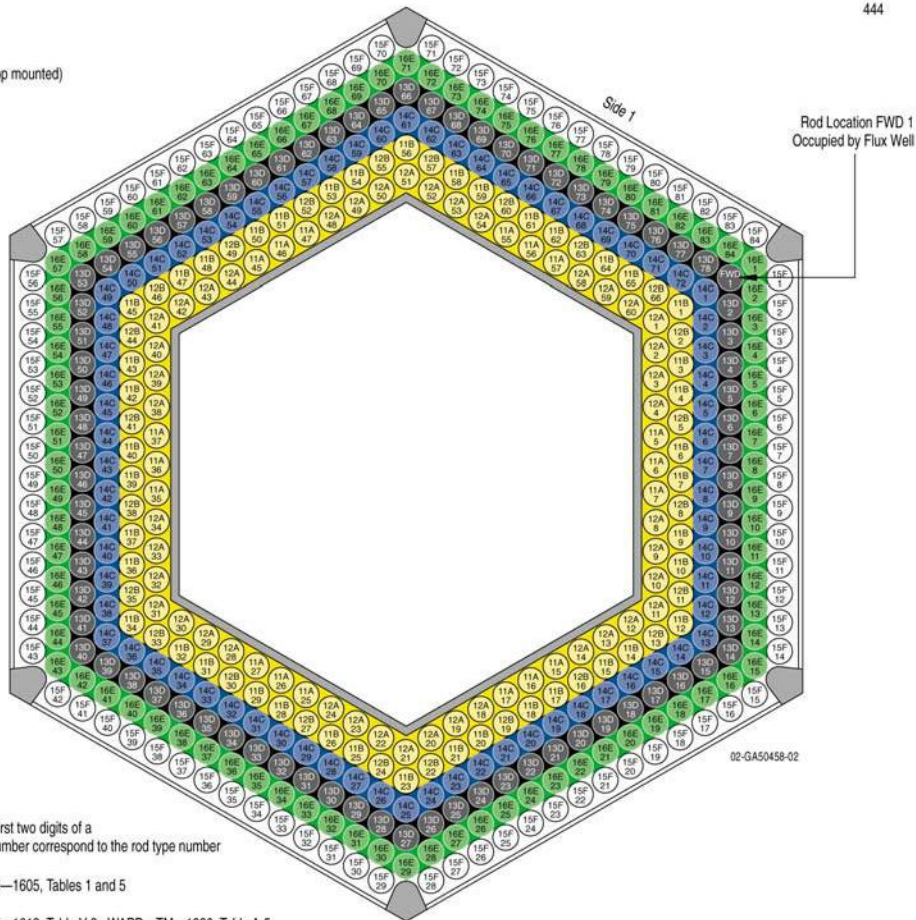

Figure 3-6. Light Water Breeder Reactor movable seed module rod arrangement and cell identification (modified from Figure A-1 of Gorscak, Campbell, and Clayton 1987, WAPD-TM-1605).

Rod Type ¹	Binary Stack Length	Fissile Concentration (U-fissile wt %) ²	Theoretical Density (g/cm ³) ²	Mass Initial Fissile (g/Rod) ³	Number of Rods/Module
	11,12	42"	1.211	10.009	126
	14	56"	1.662	10.013	72
	13	70"	2.000	10.016	78
	16	84"	2.000	10.016	84
	15	84"	1.662	10.013	84
					444

444 Rods (222 top mounted)
.5715" Diameter
.630" Pitch



¹ Rod type: First two digits of a rod serial number correspond to the rod type number
² WAPD—TM—1605, Tables 1 and 5
³ WAPD—TM—1612, Table V-2. WAPD—TM—1326, Table A-5



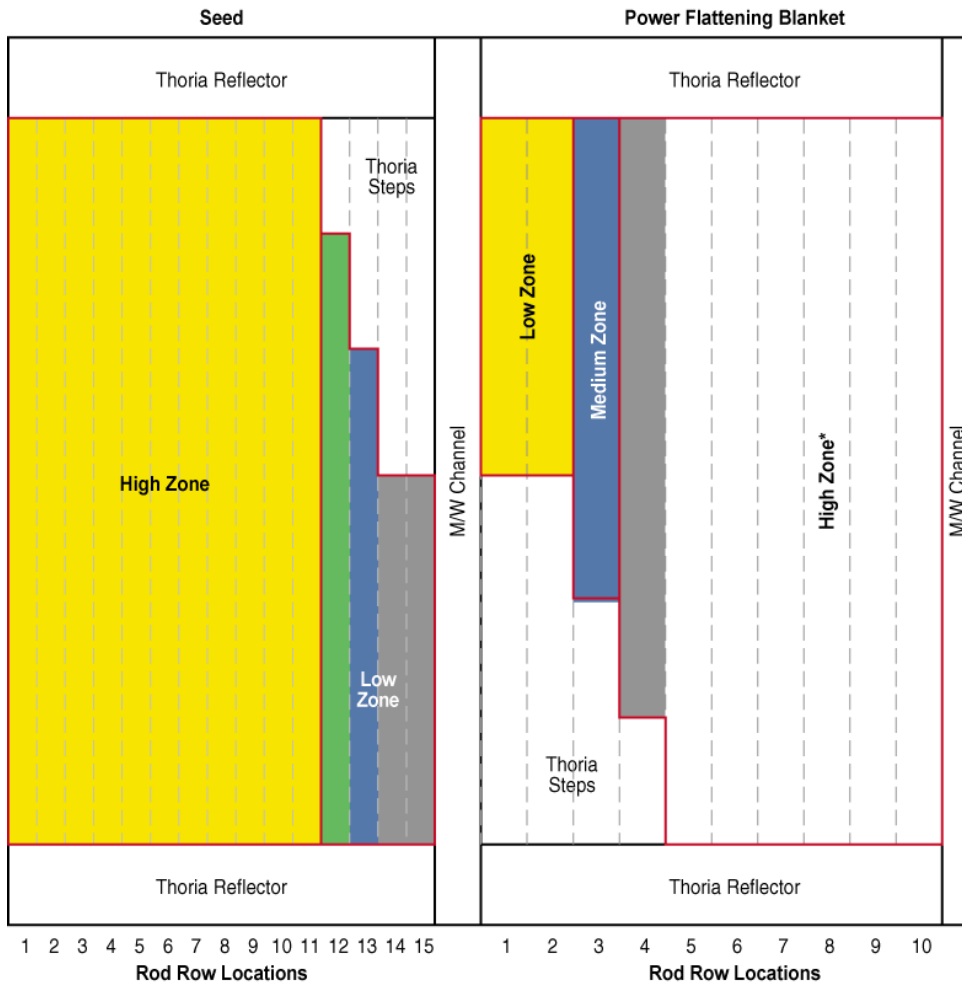

Figure 3-7. Light Water Breeder Reactor Type I blanket module rod configuration and cell identification (modified from Figure A1-2 of Gorscak, Campbell, and Clayton 1987, WAPD-TM-1605).



*Except for eight Medium zone rods per module in row six
 □(4 on each side, along interface between modules).

Y98 0399

Figure 3-8. Axial schematic of the seed surrounded by a power-flattening blanket module (modified from Hecker 1979, WAPD-TM-1326, p. 17).

Region 2							Region 1	
Region 2 Key	Rod Type ¹	Binary Stack Length ²	Fissile Concentration (U-fissile wt %) ²	Theoretical Density (g/cm ³) ²	Mass Initial Fissile (g)/Rod ³	Number of Rods/Module	Rod Type ¹	Number of Rods/Module
	21, 22	42"	1.649	10.013	18.96	46	11, 12	80
	24	56"	2.005	10.016	30.74	29	14	43
	23	70"	2.733	10.022	52.56	33	13	45
	25, 26	84"	2.733	10.022	63.06	187	16	47
	27	84"	2.005	10.016	46.4	8	15	46
						303	261	

Region 1
261 Standard Rods (131 top mounted)
.5712" Diameter
.630" Pitch



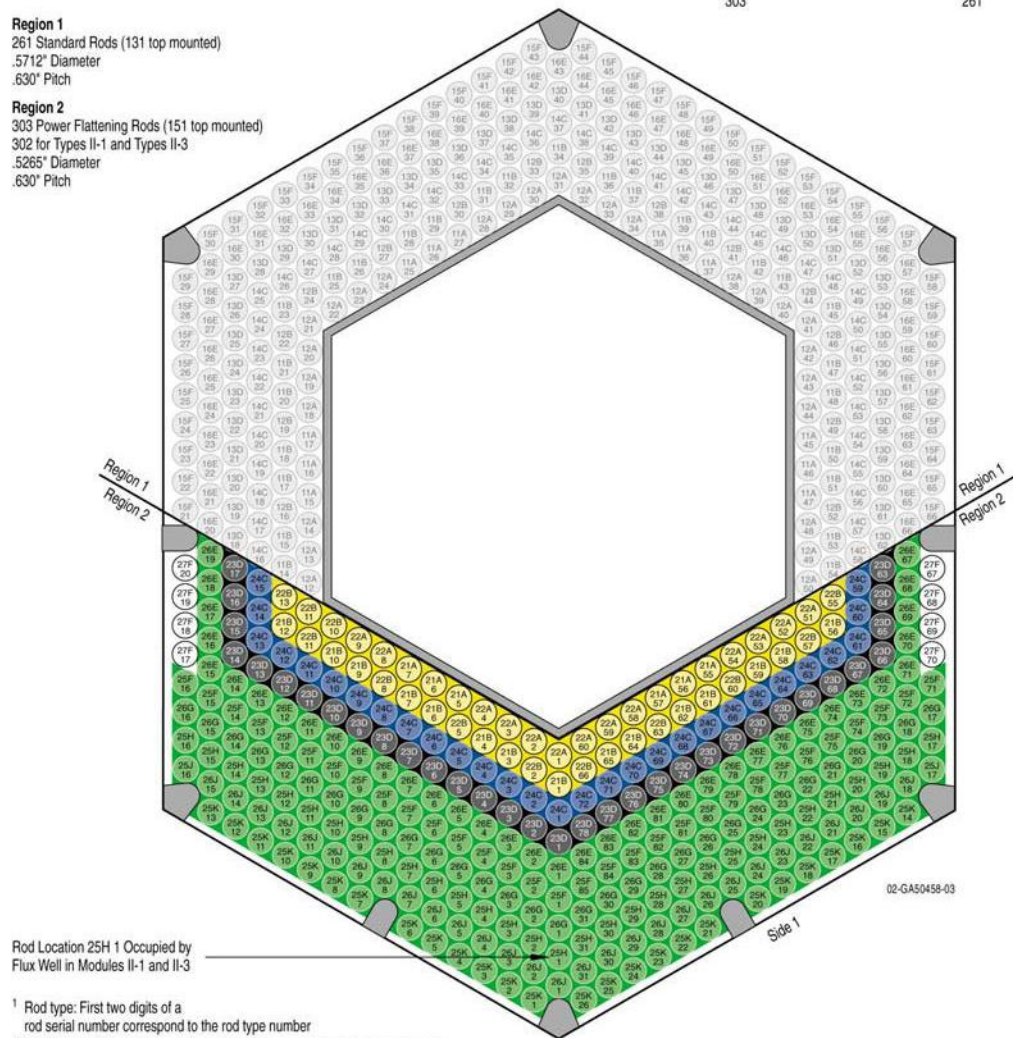

Region 2
303 Power Flattening Rods (151 top mounted)
302 for Types II-1 and Types II-3
.5265" Diameter
.630" Pitch



Rod Location 25H 1 Occupied by Flux Well in Modules II-1 and II-3

¹ Rod type: First two digits of a rod serial number correspond to the rod type number
² WAPD-TM-1605, Table 5. **NOTE:** Values for types 26 and 27 are erroneously switched in the source document.
³ WAPD-TM-1612, Table V-2. WAPD-TM-1326, Table A-5

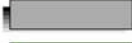
Figure 3-9. Type II blanket module rod and cell identification (modified from Figure A1-3 of Gorscak, Campbell, and Clayton 1987, WAPD-TM-1605).

Region 2							Region 1	
Region 2 Key	Rod Type ¹	Binary Stack Length ²	Fissile Concentration (U-fissile wt %) ²	Theoretical Density (g/cm ³) ²	Mass Initial Fissile (g/Rod) ³	Number of Rods/Module	Rod Type ¹	Number of Rods/Module
	21, 22	42"	1.649	10.013	18.96	67	11, 12	59
	24	56"	2.005	10.016	30.74	41	14	31
	23	70"	2.733	10.022	52.56	46	13	32
	25, 26	84"	2.733	10.022	63.06	284	16	33
	27	84"	2.005	10.016	46.4	8	15	32
446							187	

Region 1
187 Standard Rods (94 top mounted)
.5715" Diameter
.630" Pitch

Region 2
446 Power Flattening Rods (94 top mounted)
445 for Types III-1 and Types III-2
.5265" Diameter
.630" Pitch

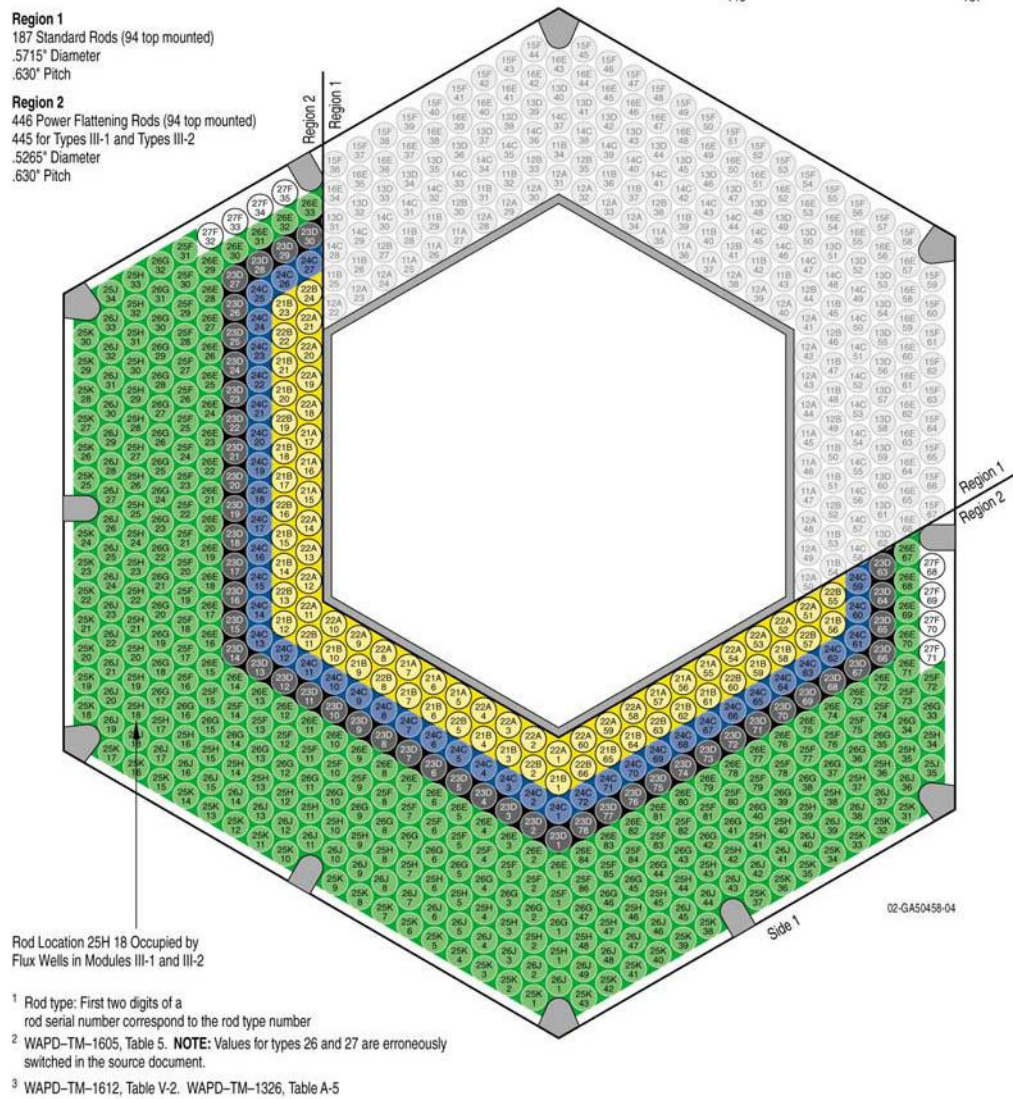

Figure 3-10. Type III blanket module rod and cell identification (modified from Figure A1-4 of Gorscak, Campbell, and Clayton 1987, WAPD-TM-1605).

Table 3-2. Masses of uranium isotopes in the seed modules and in the power flattening and standard portions of the blanket modules at beginning of life (Hecker 1979, WAPD-TM-1326, Table A-14). NOTE: Type II and III blanket modules consist of standard and power flattening components.

Type	Module		Rods	U-232 Grams	U-233 Grams	U-234 Grams	U-235 Grams	U-236 Grams	U-238 Grams	U-Fliso Grams	Thorium KGS	Mean Clad		Mean Grid	
	S/N	S/N										OD Inches	Wall Inches	Pitch Inches	Wgt Grams
I-1	L-BB01-04		619	0.1199	16512.0	215.2	13.0	2.7	48.9	16525.0	433.607	0.30626	0.02221	0.36851	1533.
I-2	L-BB01-05		619	0.1182	16513.9	218.1	15.0	3.2	48.7	16528.8	433.601	0.30620	0.02218	0.36861	1533.
I-3	L-BB01-06		619	0.1196	16522.5	215.8	12.2	2.7	48.8	16534.7	433.919	0.30630	0.02222	0.36850	1531.
II-1	L-BB01-09		619	0.1189	16528.6	215.2	11.8	2.6	48.6	16540.4	433.890	0.30636	0.02226	0.36857	1539.
II-2	L-BB01-10		619	0.1188	16528.7	216.0	12.5	2.7	47.9	16541.2	433.660	0.30636	0.02219	0.36852	1549.
II-3	L-BB01-13		619	0.1201	16567.1	215.2	11.5	2.5	45.9	16578.6	434.097	0.30626	0.02215	0.36863	1542.
E	III-1 L-BB01-07		619	0.1207	16511.4	214.2	12.3	2.5	49.1	16523.6	433.571	0.30621	0.02214	0.36857	1541.
D	III-2 L-BB01-08		619	0.1208	16543.6	214.1	11.0	2.3	47.4	16554.6	433.882	0.30621	0.02212	0.36859	1542.
	III-3 L-BB01-12		619	0.1212	16554.8	214.1	10.9	2.3	47.5	16565.7	434.082	0.30621	0.02212	0.36859	1542.
	III-4 L-BB01-11		619	0.1196	16550.2	214.0	10.9	2.3	47.3	16561.1	434.090	0.30627	0.02218	0.36850	1550.
	III-5 L-BB01-14		619	0.1197	16560.2	213.9	10.7	2.2	46.7	16570.9	434.114	0.30620	0.02213	0.36863	1552.
	III-6 L-BB01-16		619	0.1205	16554.4	214.9	11.4	2.5	47.4	16565.8	434.047	0.30621	0.02214	0.36857	1557.
	Seed Totals		7428	1.4380	198447.4	2580.7	143.2	30.5	574.2	198590.4	5206.560				
S	I-1 L-GU52-01		443	0.1353	16171.3	220.1	15.7	4.4	42.1	16187.0	1299.455	0.57171	0.02808	0.63049	2239.
T	I-2 L-GU52-02		443	0.1360	16169.1	218.6	14.9	4.1	42.2	16184.0	1299.371	0.57166	0.02806	0.63040	2230.
D	I-3 L-GU51-01		443	0.1365	16166.6	217.1	14.0	3.7	42.3	16180.5	1299.300	0.57168	0.02811	0.63044	2228.
	II-1 L-GU51-01		261	0.0784	9328.5	125.5	8.3	2.2	24.6	9336.8	765.649	0.57172	0.02809	0.63053	1314.
B	II-2 L-G822-01		261	0.0778	9326.7	126.9	9.1	2.5	24.4	9335.8	765.910	0.57176	0.02817	0.63044	1313.
L	II-3 L-GV52-01		261	0.0785	9331.3	126.2	8.6	2.4	24.3	9340.3	765.716	0.57165	0.02806	0.63051	1310.
A	III-1 L-GU51-01		187	0.0554	6622.3	90.1	6.4	1.8	17.2	6628.8	548.505	0.57166	0.02807	0.63029	930.
N	III-2 L-GU52-01		187	0.0552	6625.5	90.4	6.6	1.9	17.3	6632.1	548.695	0.57156	0.02805	0.63020	935.
K	III-3 L-GU53-01		187	0.0551	6621.1	90.5	6.7	1.9	17.2	6627.8	548.624	0.57172	0.02806	0.63024	933.
E	III-4 L-GT22-01		187	0.0550	6626.2	90.2	6.5	1.8	17.3	6632.7	548.692	0.57172	0.02812	0.63021	935.
T	III-5 L-GT22-02		187	0.0554	6628.6	90.3	6.5	1.8	17.3	6635.1	548.720	0.57166	0.02811	0.63021	932.
	III-6 L-GT22-03		187	0.0547	6622.1	91.3	7.1	2.1	17.2	6629.2	548.463	0.57163	0.02800	0.63028	930.
	Blkt Totals		3234	0.9733	116239.8	1577.2	110.4	30.6	303.4	116350.1	9487.100				
P	II-1 L-GU51-01		302	0.1148	15508.5	202.4	16.2	4.7	77.9	15604.7	741.395	0.52755	0.02643	0.63053	1525.
F	II-2 L-G822-01		302	0.1145	15643.5	198.7	14.8	3.9	90.5	15658.3	743.518	0.52745	0.02646	0.63044	1525.
B	II-3 L-G822-01		302	0.1137	15586.2	192.9	13.3	3.4	95.5	15599.5	741.370	0.52742	0.02644	0.63051	1521.
A	III-1 L-GU51-01		445	0.1696	23153.1	291.5	21.1	5.7	132.6	23174.2	1092.258	0.52743	0.02640	0.63029	2217.
N	III-2 L-GU52-01		445	0.1687	23129.3	306.0	26.3	7.6	117.1	23155.6	1092.029	0.52740	0.02638	0.63020	2230.
K	III-3 L-GU53-01		446	0.1688	23209.8	289.3	20.5	5.3	141.3	23230.3	1094.481	0.52744	0.02643	0.63024	2224.
E	III-4 L-GT22-01		446	0.1700	23195.6	310.2	27.3	7.9	112.0	23222.9	1094.361	0.52746	0.02641	0.63021	2229.
F	III-5 L-GT22-02		446	0.1698	23199.2	303.6	25.2	7.2	120.0	23224.4	1094.561	0.52741	0.02643	0.63021	2222.
T	III-6 L-GT22-03		446	0.1693	23208.2	295.4	22.6	6.0	136.1	23230.8	1094.307	0.52744	0.02640	0.63028	2218.
	PFBK Totals		3581	1.3592	185913.4	2390.0	187.3	51.7	1023.0	186100.7	8788.283				
	Core Totals		14243	3.7705	506600.6	6547.9	440.9	112.8	1900.6	501041.2	23481.943*				

* Excluding reflector blanket thorium

uranium homogeneity limits was achieved by comiconizing and by thoroughly mixing the binary compositions. High density was achieved by using micronized powder and a slightly higher than normal sintering temperature (Gorscak Campbell, and Clayton 1987, WAPD-TM-1605, p. 20–21).

Best estimate melting point is about 5950°F for UO₂-ThO₂ fuel systems containing 2 to 6 wt% UO₂. Thermal conductivity and corrosion resistance of the thoria-based system was higher than the uranium system (Gorscak, Campbell, and Clayton 1987, WAPD-TM-1605, p. 21).

Pellets were loaded into Zircaloy-4 cladding tubes, which were welded at both ends to solid end plugs (Atherton 1987, WAPD-TM-1600, Section 3-2). Within the tube and above the fuel stack, there was a plenum void to house the plenum spring, which allowed fuel stack expansion to accept fission gas released from the fuel. This design served to minimize internal gas pressure.

Because impurities interfered with the breeding performance of the fuel, there was a need to tightly quantify and control the amount of impurities allowed in the fuel. Neutron poison equivalence (NPE) was calculated on every tenth pellet blend. The NPE was an index that accounted for the amount and neutron absorption properties of each impurity. Elements with large neutron absorption cross sections could be tolerated at only low levels, whereas elements with moderate cross sections could be tolerated at higher levels. Impurities with extremely low cross sections might not need to be controlled at all from the point of view of breeding. The neutron absorption capability of one part cobalt per million parts of thorium was assigned a reference value of 1.0. Mass spectrometry was used to quantify fuel impurities. NPE is discussed in Hecker 1979, WAPD-TM-1326, Appendix B, and NPE data are presented in Table 3-3.

3.2.1 Pellets

The LWBR core contained about 3 million fuel pellets. Approximately 1.6 million of the pellets were binary (uranium oxide-thorium oxide), and the rest were thoria. There were several different sizes, shapes, and enrichments of pellets fabricated for the various rod types. All pellets were ceramic, more or less right circular cylinders, and either ThO₂ or binary (ThO₂-²³³UO₂). Binary pellets were used only in the seed and blanket modules of the reactor. There were eight sizes of binary pellets. Thoria pellets were fabricated in four different sizes; one for each type of rod (i.e., seed, standard blanket, power flattening blanket, and reflector rods). Table 3-4 lists the properties of the pellets used in the various zones of the core. Pellet dimensions with uncertainties are presented in Table 3-5.

The fuel pellets contained from 1–5 wt% UO₂ in a thoria matrix (Walter and Weinreich 1976, WAPD-TM-1244(L), p. I-2). Uranium in the UO₂ was 98.23% enriched with fissile U-233 (Hecker 1979, WAPD-TM-1326, p. 11; Schick et al. 1987, WAPD-TM-1612, p. 5). The percentage of theoretical densities for the pellets ranged from 97.28 to 98.61%. Table 3-6 lists the theoretical densities and void fractions for the various types of pellets.

Each powder blend, either binary or thoria, received a unique blend designation. A representative sample of pellets from a blend was taken and used to determine the characteristics of the blend. The pellet properties that were measured and needed for the computational model of the core were length, diameter, and weight for all pellets in the sample, and weight percent (wt%) of total uranium and uranium isotopic weight percents for binary pellets. These properties for binary pellets were stored in a computer file for each binary blend manufactured and used to compute uranium and thorium loadings of binary fuel rods (Freeman 1978, WAPD-TM-1314, pp. 27–28).

Table 3-3. Neutron Poison Equivalence (NPE) (Hecker 1979, WAPD-TM-1326, Table A-17).

<u>Composition</u>	<u>Blends Sampled</u>	<u>Average NPE</u>
Low seed	13	14.3
High seed	23	14.2
Low standard blanket	3	17.1
Medium standard blanket	21	13.2
High standard blanket	9	17.7
Low power flattening blanket	2	15.8
Medium power flattening blanket	2	14.3
High power flattening blanket	5	19.3
All binary	78	14.8
Seed thoria	5	15.2
Standard blanket thoria	18	14.7
Power flattening blanket thoria	4	6.8
Reflector blanket thoria	36	28.7
All thoria	63	22.2
All binary and thoria	141	18.2

Table 3-4. Average as-built Light Water Breeder Reactor pellet characteristics (Hecker 1979, WAPD-TM-1326, Table II-2). **NOTE:** The zones specified below correspond with the zones depicted in Figures 3-5 through 3-10.

Seed	Pellet OD	Pellet Length	Percent of Theoretical Density	U-Fissile (w/o)*	U-Fissile (grams/in.)	Fissile Loading (kg)	Loading Th-232 (kg)
	(in.)	(in.)	Density	(w/o)*	(grams/in.)	(kg)	(kg)
<u>Thoria</u>							
Low zoned	0.2556	0.530	98.01	None	None	None	1846.6
High zoned	0.2520	0.444	97.71	4.337	0.3416	61.28	1179.5
	0.2520	0.615	97.55	5.202	0.4114	137.31	2180.4
<u>Standard Blanket</u>							
<u>Thoria</u>							
Low zoned	0.5106	0.616	97.80	None	None	None	3670.0
Medium zoned	0.5105	0.531	98.61	1.214	0.3920	15.99	1141.6
High zoned	0.5105	0.868	98.22	1.668	0.5421	42.68	2205.9
	0.5105	0.785	98.11	2.005	0.6498	57.67	2469.6
<u>Power Flattening Blanket</u>							
<u>Thoria</u>							
Low zoned	0.4696	0.447	98.06	None	None	None	2632.4
Medium zoned	0.4695	0.870	98.03	1.654	0.4537	10.24	533.5
High zoned	0.4695	0.786	98.04	2.009	0.5509	13.58	580.1
	0.4696	0.701	97.91	2.739	0.7492	162.29	5042.3
<u>Radial Reflector Blanket</u>							
TOTAL	0.7417	0.741	97.28	None	None	None	18574.2
						501.04	42056.1

$$*U\text{-Fissile (w/o)} = \frac{U\text{-233} + U\text{-235}}{UO_2 + ThO_2} \times 100$$

U Isotopic Composition

U-232	<0.001 w/o
U-233	98.23
U-234	1.29
U-235	0.09
U-236	0.02
U-238	0.37

Table 3-5. Light Water Breeder Reactor fuel pellet dimensions (Campbell and Giovengo 1987, WAPD-TM-1387, Table 4).

Zircaloy-4 Cladding	Seed	Standard Blanket	Power Flattening Blanket	Reflector
Outside Diameter	0.306 ± .0015 avg + .003 - .002 local	0.5715 ± .0015 avg ± .0025 local	0.5275 ± .0015 avg ± .0025 local	0.832 ± .003 avg ± .003 local
Inside Diameter	0.262 ± .002 local ± .001 avg	0.516 ± .002 local ± .001 avg	0.475 ± .002 local ± .001 avg	0.748 ± .001 avg ± .0025 local
Nominal Wall Thickness	0.022	0.02775	0.02625	0.042
Outside Diameter to Thickness Ratio	13.9	20.6	20.1	19.8
Cladding Heat Treatment**	RXA	SRA	SRA	SRA
<u>UO₂-ThO₂ Fuel Pellets</u>				
Diameter	0.252 ± .0005	0.5105 ± .0005	0.4695 ± .0005	-
Length	0.445 ± .020 0.615 ± .020	0.530 ± .020 0.870 ± .020 0.785 ± .020	0.870 ± .020 0.700 ± .020 0.055 ± .015	- - -
End Shoulder Width	0.046 ± .008	0.055 ± .015	0.055 ± .015	-
Endface Dish Depth	0.009 ± .003	0.014 ± .004	0.014 ± .004	-
Chamfer or Taper- Depth	0.015 ± .005	0.001 - 0.004	0.001 - 0.004	-
Length	0.015 ± .015	0.100 - 0.200	0.100 - 0.200	-
Range of Individual Pellet Densities, % of Theoretical	94.55 - 99.27	96.55 - 99.38	95.26 - 98.60	-
Fuel-Cladding Diametral Gap	0.0085 - 0.0115	0.004-0.007	0.004-0.007	-
<u>ThO₂ Fuel Pellets</u>				
Diameter	0.2555 ± .0005	0.5105 ± .0005	0.4695 ± .0005	0.7415 ± .0005
Length	0.530 ± .020	0.615 ± .020	0.445 ± .020	0.740 ± .060
End Shoulder Width	0.055 ± .010	0.055 ± .010	0.055 ± .010	0.074 ± .010
Endface Dish Depth	0.009 ± .003	0.014 ± .004	0.014 ± .004	0.014 ± .004
Edge Configuration	0.015 ± .005 Chamfer	0.006 ± .004 Chamfer	0.006 ± .004 Chamfer	Square Edge
Range of Individual Pellet Densities, % of Theoretical	95.14 - 99.75	93.10 - 99.36	95.37 - 99.95	93.08 - 99.08
Fuel-Cladding Diametral Gap	0.005 - 0.008	0.004 - 0.007	0.004 - 0.007	0.005 - 0.008

* All dimensions are in inches, except as noted.

** RXA = Recrystallization Annealed
SRA = Stress Relief Annealed

Table 3-6. Average as-built pellet density and void fraction (Hecker 1979, WAPD-TM-1326, Table A-10).

	<u>Percent Theoretical Density</u>	<u>Theoretical Density (gm/cm³)</u>	<u>Void Fraction</u>
<u>Seed</u>			
Thoria	98.013	9.999	0.01253
Low zoned	97.712	10.035	0.01704
High zoned	97.554	10.042	0.01172
<u>Standard Blanket</u>			
Thoria	97.796	9.999	0.01399
Low zoned	98.608	10.009	0.02494
Medium zoned	98.224	10.013	0.01335
High zoned	98.115	10.016	0.01600
<u>Power Flattening Blanket</u>			
Thoria	98.057	9.999	0.01966
Low zoned	98.034	10.013	0.01998
Medium zoned	98.041	10.016	0.01753
High zoned	97.906	10.022	0.01578
<u>Reflector Blanket</u>			
	97.282	9.999	0.01317

Hundreds of pellets were loaded in each rod; hundreds of rods were loaded in each of the core's 39 modules. The uranium concentrations varied between types of pellets, but differing concentrations were not mixed in the same rod; all binary pellets in any given rod had the same wt% of fissile uranium. More detail about pellets in the seed, blanket, and reflector rods is presented in Section 3.2.2.

Production specifications for the powder used in production of the fuel pellets are provided in Table 3-7. The surface area and particle size shown were necessary for the production of high density, high integrity thoria, and binary pellets. Surface areas were monitored using a gas absorption surface area analyzer, and statistical limits were imposed for postmicronized surface areas. Surface area measurement was an essential product control for micronized powders (Walter and Weinreich 1976, WAPD-TM-1244(L), p. V.C-2). Grain size of LWBR fuel at end-of-life (EOL) is shown in Table 3-8.

Table 3-7. Production specifications for pellets (Walter and Weinreich 1976, WAPD-TM-1244(L), Table V.C-1).

<u>Powder Type</u>		<u>Typical As-Received Characteristics</u>	<u>Typical As-Micronized Characteristics</u>
ThO ₂ -UO ₂	Surface area	4.5-6.0 m ² /g	8.0-9.0 m ² /g
	Average particle size	1.5-2.2 μ	0.5 μ
ThO ₂	Surface area	6.5-7.5 m ² /g	9.0-9.5 m ² /g
	Average particle size	1.4-1.8 μ	0.5 μ

Table 3-8. Grain size of Light Water Breeder Reactor fuel at end-of-life (Richardson et al. 1987, WAPD-TM-1606, Table 8).

Rod Type	Rod S/N	Fast Neutron Fluence 10^{20} n/cm ²	Burnup (MWD/MTM)	Grain Diameter, μ m		ASTM Grain Size		Type Pellet
				Edge	Center	Edge	Center	
Seed	0400736	49	24,850	60	70	5.3	4.6	Binary
		54	36,990	40	40	6.3	6.4	Binary
	0606773	96	40,870	70	80	4.8	4.3	Binary
		33	17,300	65	80	5.0	4.5	Binary
	0205071	75	51,580	N/M	N/M	N/M	N/M	Binary
	0507672	86	46,900	95	125	3.8	3.0	Binary
Standard Blanket	1606710	73	22,350	150	80	2.6	4.3	Binary
		58	18,910	125	70	3.0	4.6	Binary
	1504272	64	19,130	115	105	3.3	3.6	Binary
	1105717	71	23,090	150	105	2.6	3.6	Binary
		71	13,750	65	50	5.0	5.6	Thoria
	1208823	51	10,180	75	N/M	4.6	N/M	Thoria
Power Flattening Blanket	2514164	39	22,320	70	45	4.6	6.0	Binary
		42	17,520	80	45	4.5	5.9	Binary
	2607600	59	24,290	150	85	2.6	4.2	Binary
	2610746	57	24,790	75	55	4.6	5.3	Binary
Reflector	3102657	4	280	45	N/M	6.0	N/M	Thoria

N/M = Not Measured
MWD/MTM = Megawatt days per metric ton of metal (uranium plus thorium)

3.2.2 Rods

Fuel rods were fabricated with many features that had never been used in fuel elements of commercial reactors. Uranium-233 was selected for the fissile fuel, because it has the largest neutron regeneration factor ($\eta = 2.3$) in the thermal and epithermal region of any of the potential fissile fuels (Pu-239, Pu-241, U-235, and U-233) (see Section 3). In addition, U-233 has a much lower total fission gas release at typical operating heat flux conditions. Assuming iodine release is proportional to total fission gas release, less iodine is released using U-233 in thoria, resulting in less iodine stress corrosion cracking in the cladding (Campbell and Giovengo 1987, WAPD-TM-1387, p. 27).

There were 23 different rod types in the LWBR core, namely 8 seed rod types, 6 standard blanket rod types, 7 power-flattening blanket rod types, and 2 reflector rod types (DeGeorge and Goldberg 1986, WAPD-TM-1278, p. II-1). Each fuel rod was composed of a Zircaloy-4 seamless tube filled with fuel pellets. The fuel rods in each region of the core were of a different diameter, physical length, binary stack length (length of the rod occupied by binary pellets), and initial uranium loadings. Radial and axial variations of fuel loading were employed in every region of the core except the reflector modules. Rod lengths ranged from about 110 to 118 in., and diameters ranged from 0.3 to 0.8 in. (Table 3-9). Irradiation of the rods caused the rod diameters to shrink. Shrinkage measured in a sample of rod types were: (Gorscak, Campbell, and Clayton 1987, WAPD-TM-1605, Table 15)

Seed	1.2 to 2.5 mils (0.03 to 0.06 mm)
Standard blanket	2.9 to 3.8 mils (0.07 to 0.10 mm)
Power-flattening blanket	2.4 to 2.8 mils (0.06 to 0.07 mm)
Reflector	2.9 to 5.5 mils (0.07 to 0.14 mm)

A plenum region at the top of each rod provided void volume to accommodate released fission gas, and a helical coiled spring to exert pressure on the pellets to keep the stack together.

Tops and bottoms of the seed and blanket rods were packed with at least 10 in. of thoria pellets (see Figures 3-5 and 3-8) for the purpose of reducing axial neutron leakage from the core. Rods with shorter stack lengths had more thoria pellets. The overall pellet stack length in each rod, including the thoria pellets, was about 104 in. Beginning and end-of-life fissile loading is addressed in Section 5 and listed by rod type in Table 5-1.

Rods varied slightly in length, depending on their location and loading within the core. Seed rods were about 117 in., and blanket rods were about 118 in. Shim pellets of thoria fuel were used near the top and bottom of the fuel stack to make up the desired fuel stack length. A spring-bearing fuel pellet with only one dished end was used at the top of the fuel stack.

3.2.2.1 Seed Region. LWBR seed modules had eight types of seed fuel rods designated as 01, 02, 03, 04, 05, 06, 07, and 08 (Figure 3-6). Rod types with odd designations were fixed to a baseplate at the bottom of the seed module, and rod types with even designations were fixed to a baseplate at the top end of the module. Nominal rod dimensions are shown for the eight types of seed rods in Figure 3-11. Seed rods weighed about 2 lb each (Gorscak, Campbell, and Clayton 1987, WAPD-TM-1605, p. 37) and had a 10 in. plenum at the top of the fuel stack to accommodate fission gas release. The plenum included an Inconel compression spring at the top of the stack to minimize formation of axial gaps in the stack during handling, normal reactor operation, and shock loading (e.g., from scrams, check valve slams, earthquakes) (Gorscak, Campbell, and Clayton 1987, WAPD-TM-1605, p. 8-13).

Table 3-9. Light Water Breeder Reactor fuel rod dimensions* (Gorseak, Campbell, and Clayton 1987, WAPD-TM-1605, Table 4).
LWR Fuel Rod Dimensions*

<u>Attribute</u>	<u>Seed</u>	<u>Standard Blanket</u>	<u>Power Flattening Blanket</u>	<u>Reflector</u>
Rod length	116.620 ±.065	117.650 ±.065	117.650 ±.065	110.85 ±0.065
Cladding Type**	RXA	SRA	SRA	SRA
Cladding Outside***	0.306 ±.0015 +.003 -.002	0.5715 ±.0015 ±.0025	0.5275 ±.0015 ±.0025	0.832 ±.003
Cladding Inside***	0.262 ±.001 ±.002	0.516 ±.001 ±.002	0.475 ±.001 ±.002	0.748 ±.001 ±.002
OD/t	13.9	20.6	20.1	19.8
Pellet Diameter	0.252 ±.0005	0.5105 ±.0005	0.4695 ±.0005	0.7415 ±.0005
Cladding-Pellet Radial Gap	0.0042- 0.0057	0.002- 0.0035	0.002- 0.0035	0.002- 0.0045
Plenum Length	10.0 ±.100	9.9 ±.055	9.9 ±.055	3.955 ±.040

*All dimensions in inches, except as noted

**RXA - Recrystallization Annealed

SRA - Stress Relief Annealed

***Average and local tolerance

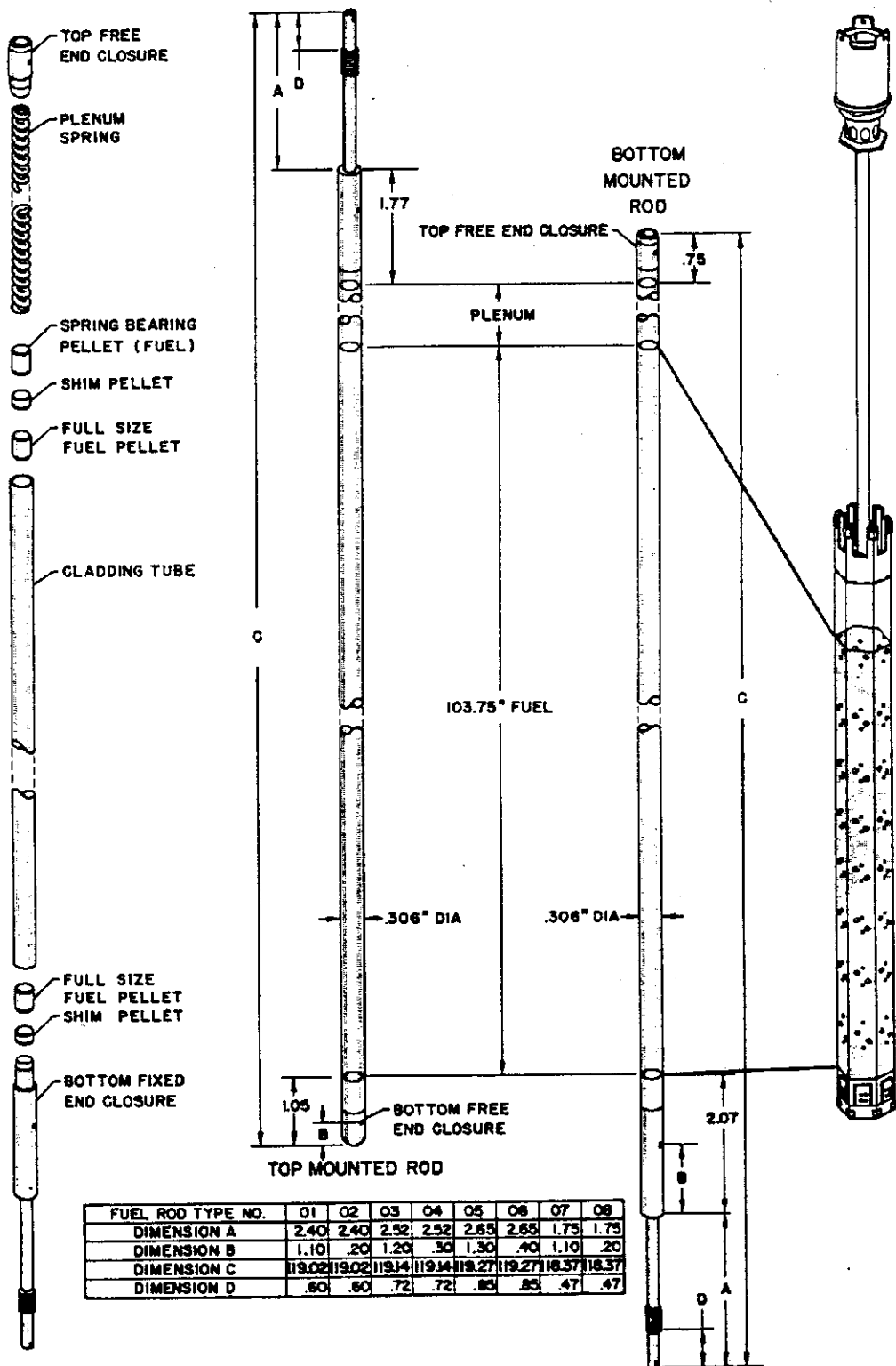

Figure 3-11. Light Water Breeder Reactor seed fuel rods (Gorscak, Campbell, and Clayton 1987, WAPD-TM-1605, Figure 3).

The seed fuel rods had four different stack lengths (42, 56, 70, or 84 inches, Figure 3-6). Figure 3-11 shows a seed fuel rod and identifies the varying dimensions of the eight different types of seed rods (identified as 01–08 in the imbedded table). The rod type identifiers correspond with the identifiers provided in Figure 3-6 and Table 5-1.

Seed pellets were right circular cylinders with chamfers on both ends to ease loading into tubing, facilitate movement of the pellet stack in the tubing during power operation, and reduce pellet chipping during fabrication, rod handling, and power operation. The seed pellets had dished ends to reduce axial expansion of the stack (Walter and Weinreich 1976, WAPD-TM-1244(L)).

Binary pellets used in the seed rods were 0.252 in. in diameter and either 0.445 or 0.615 in. long. The shorter pellets had enrichments of about 4.3 wt% U-fissile (Table 3-4). The longer (0.615 in.) pellets had identical diameters, but enrichments of 5.2 wt% U-fissile (Table 3-4). The pellets were sintered to 97 or 98% of their theoretical density of about 10 g/cm³ to maximize pellet dimensional stability (Hecker 1979, WAPD-TM-1326). Dimensions for seed fuel pellets are presented in Tables 3-4 and 3-5.

3.2.2.2 Standard Blanket Region. The standard blanket region of the core included all of the Type I blankets and the interior portions of the Type II and Type III blankets (see Figure 2-3). Three types of binary pellets and various stack lengths were used in the standard blankets. The binary pellets used contained 1.211, 1.662, or 2.000 wt% urania. There were four binary stack lengths and three zones in the Standard Blanket Region of the core (see Figures 3-5 and 3-7).

There were three types of binary pellets manufactured for the standard blanket rods (see Tables 3-4 and 3-5). The binary pellets were right circular cylinders with tapers on both ends to minimize ridging of cladding due to pellet hourglassing and had dished ends to reduce fuel stack axial expansion (Campbell and Giovengo 1987, WAPD-TM-1387).

Figure 3-12 shows LWBR standard and power-flattening blanket fuel rods. There were six types of standard blanket fuel rods designated as 11, 12, 13, 14, 15, and 16 (corresponding to identifiers in Figure 3-7 and Figure 3-12). Rod types with odd designations were fixed to the bottom of the modules. Rod types with even designations were fixed to the top of the module (Gorscak, Campbell, and Clayton 1987, WAPD-TM-1605, p. 13). Loading and binary stack lengths for standard blanket fuel rods are presented in Figure 3-7. Standard blanket rods weighed about 8 lb each, (Gorscak, Campbell, and Clayton 1987, WAPD-TM-1605, p. 37).

3.2.2.3 Power-flattening Blanket Region. The power-flattening blanket region of the core was located inside the reflector region and consisted of Type II and Type III blanket modules. Two of the six sides of the Type II modules were power-flattening sides; three of the six sides of the Type III modules were power-flattening sides. The power-flattening regions were created using three types of pellets (1.649, 2.005, and 2.773 wt%) with three zones and four binary stack lengths (see Figures 3-8 and 3-10). Average as-built characteristics for the pellets used in the power-flattening rods are presented in Table 3-4.

There were seven types of power-flattening blanket fuel rods, designated as 21, 22, 23, 24, 25, 26, and 27 (corresponding to identifiers in Figures 3-9 and 3-10). Figure 3-12 shows a power-flattening blanket rod. Each power-flattening rod weighed about 7 lb (Gorscak, Campbell, and Clayton 1987, WAPD-TM-1605, p. 37).

3.2.2.4 Reflector. The reflector modules contained rods with only thoria pellets. Rod configurations for Type IV and V reflectors are shown in Figures 3-2 and 3-3.

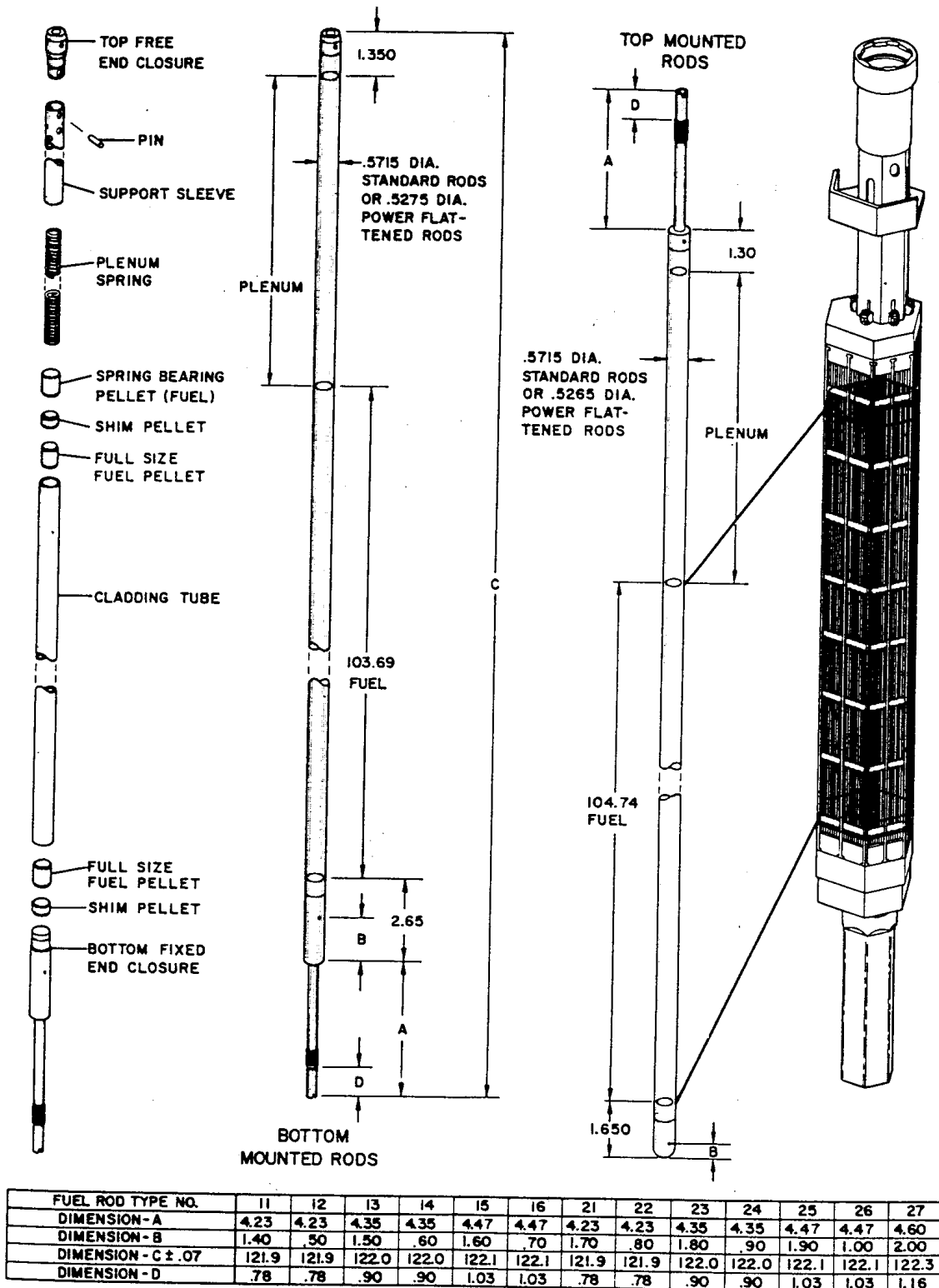

Figure 3-12. Light Water Breeder Reactor blanket fuel rods (Gorscak, Campbell, and Clayton 1987, WAPD-TM-1605, Figure 4). Standard and power-flattening rods are depicted here. Standard rods have a rod type number <20.

Figure 3-13 shows a reflector rod. Reflector rods had only two rod types: 31 and 32. Rod Type 31 was attached to the bottom of the module, and rod Type 32 was attached to the top of the fuel module. Both types contained only thoria pellets.

Reflector fuel rods had a 4-in. plenum with an Inconel support sleeve. The axial gap between the support sleeve and the top of its pellet stack was nominally 0.23 in. Each reflector rod had an Inconel compression spring at the top of the fuel stack to minimize the formation of in-stack pellet-to-pellet gaps. Each top-mounted reflector fuel rod had a hemispherical free end. Each bottom-mounted fuel rod had a square free end. The rods were backfilled with helium at 1 atm pressure during welding. Dimensions for reflector fuel rods are summarized in Figure 3-13 and Table 3-9. Reflector rods weighed about 16 lb each (Gorscak, Campbell, and Clayton 1987, WAPD-TM-1605, p. 37).

Pellets were right circular cylinders with square edges and had dished ends to minimize axial expansion of the fuel stack (Campbell and Giovengo 1987, WAPD-TM-1387, p. 25, Figure 9). Dimensions of reflector pellets are presented in Tables 3-4 and 3-5.

3.2.3 Beginning-of-Life Fissile Loading

Average as-built LWBR fissile loading by module type is presented in Table 3-10. Thorium and uranium loadings for the seed modules and for the standard and power-flattening portions of the blanket modules are presented in Table 3-11. There was no fissile uranium (i.e., no binary fuel) in the reflectors at beginning of life.

3.3 Cladding

3.3.1 General Description of Cladding Types

All rods were clad with Zircaloy-4 tubing (Gorscak, Campbell, and Clayton 1987, WAPD-TM-1605, pp. 10 and 17). Data for the cladding are summarized in Tables 3-5 and 3-12. Dimensions and characteristics data for tubing are provided in Table 3-13.

Seed rod cladding: The seed cladding was freestanding (i.e., the cladding would not collapse onto the fuel pellets). Seed fuel rod cladding was recrystallization annealed Zircaloy-4 (Gorscak, Campbell, and Clayton 1987, WAPD-TM-1605, pp. 8 and 13).

Blanket fuel cladding: For LWBR operating pressure and temperatures, cladding for both standard and power-flattening fuel rods was nonfreestanding (i.e., the cladding would collapse onto the fuel pellets after exposure in the core). Blanket fuel rod cladding was highly cold worked and stress relief annealed Zircaloy-4 (Gorscak, Campbell, and Clayton 1987, WAPD-TM-1605).

Reflector fuel rod cladding: Reflector cladding was highly cold worked and stress relief annealed Zircaloy-4. Cladding was nonfreestanding for LWBR operating pressure and temperature (Gorscak, Campbell, and Clayton 1987, WAPD-TM-1605, p. 17).

3.3.2 Form

To improve neutron economy, blanket and reflector fuel rods were designed with nonfreestanding, thin-walled Zircaloy-4 tubing, highly cold worked and stress relief annealed. The seed fuel rods, because of their higher duty demands, were fabricated with freestanding recrystallization annealed Zircaloy-4 cladding. All cladding was fabricated from selected Zircaloy-4 ingots with less than 50 ppm hafnium content, which is lower than normal, to reduce parasitic absorption of neutrons (Campbell and Giovengo 1987, WAPD-TM-1387, p. 10).

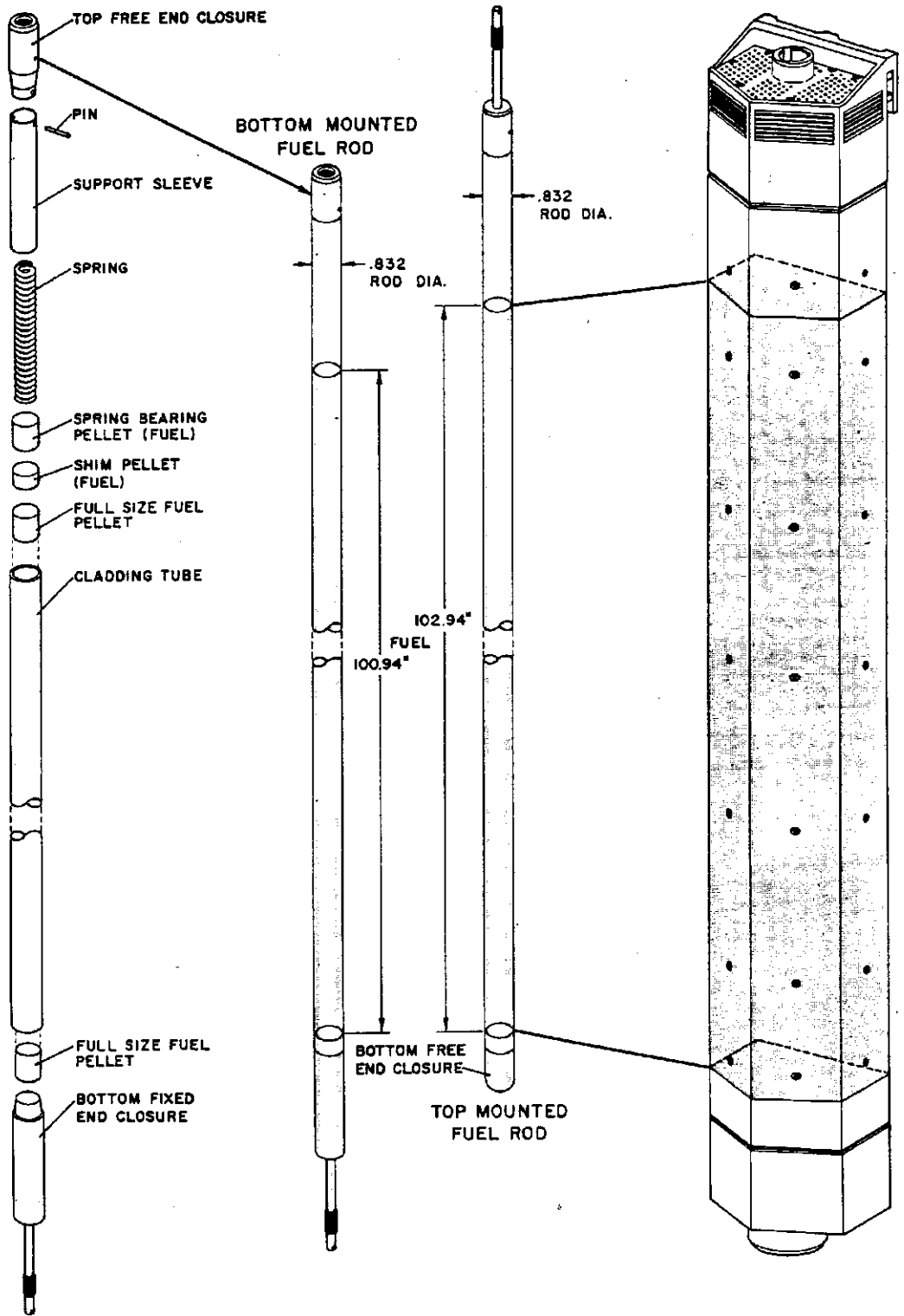

Figure 3-13. Light Water Breeder Reactor reflector fuel rods (Gorscak, Campbell, and Clayton 1987, WAPD-TM-1605, Figure 5).

Table 3-10. Average as-built Light Water Breeder Reactor loading by module type (Hecker 1979, WAPD-TM-1326, Table II-3).

<u>Module Regions</u>	<u>Fissile Loading (kg)</u>		
	<u>Type I Module</u>	<u>Type II Module</u>	<u>Type III Module</u>
Seed†	16.53	16.55	16.56
Standard blanket	16.18	9.34	6.63
Power flattening blanket	None	15.66*	23.22*
Total blanket	16.18	25.00*	29.85*
Module total	32.71	41.55*	46.41*

*Two Type II and two Type III modules have 0.06 kg less loading due to flux well locations.

†A 12-seed average of 16.55 kg was used for all seeds in the calculations.

Table 3-11. Seed and blanket module initial thorium and uranium loadings (NOTE: Type II and III blanket modules consist of both a standard and power-flattening portion) (Schick et al. 1987, WAPD-TM-1612, Table III-1).

Module	Rods	Thorium kgs	²³² U Grams	²³³ U Grams	²³⁴ U Grams	²³⁵ U Grams	²³⁶ U Grams	²³⁸ U Grams	U ^{fissile} Grams
Seed I-1	619	433.61	0.12	16505.1	215.12	13.04	2.68	48.92	16518.1
I-2	619	433.60	0.11	16506.9	218.02	14.95	3.21	48.66	16521.8
I-3	619	433.91	0.10	16522.9	215.80	12.21	2.70	48.83	16535.1
II-1	619	433.88	0.10	16529.4	215.21	11.79	2.57	48.55	16541.2
II-2	619	433.66	0.10	16528.4	216.03	12.46	2.74	47.85	16540.8
II-3	619	434.09	0.10	16568.7	215.20	11.49	2.49	45.85	16580.2
III-1	619	433.57	0.11	16505.3	214.12	12.25	2.47	49.03	16517.5
III-2	619	433.87	0.11	16545.4	214.16	11.01	2.33	47.44	16556.5
III-3	619	434.07	0.11	16557.8	214.11	10.90	2.32	47.46	16568.7
III-4	619	434.08	0.11	16552.1	214.04	10.85	2.28	47.34	16563.0
III-5	619	434.11	0.10	16562.0	213.93	10.69	2.24	46.69	16572.7
III-6	619	434.04	0.11	16557.2	214.96	11.40	2.45	47.39	16568.6
Totals	7428	5206.55	1.34	198441.2	2580.75	143.10	30.53	574.04	198584.3
Std. I-1	443	1299.45	0.13	16166.5	220.01	15.69	4.41	42.11	16182.2
Blkt. I-2	443	1299.37	0.13	16163.9	218.54	14.85	4.07	42.19	16178.7
I-3	443	1299.30	0.13	16161.5	217.06	13.97	3.73	42.24	16175.4
II-1	261	765.65	0.07	9325.4	125.49	8.26	2.22	24.56	9333.6
II-2	261	765.91	0.07	9324.0	126.84	9.05	2.53	24.39	9333.0
II-3	261	765.71	0.07	9329.1	126.12	8.55	2.35	24.31	9337.6
III-1	187	548.50	0.05	6619.9	90.10	6.42	1.81	17.20	6626.4
III-2	187	548.69	0.05	6623.3	90.39	6.59	1.86	17.25	6629.9
III-3	187	548.62	0.05	6618.4	90.50	6.67	1.90	17.18	6625.1
III-4	187	548.69	0.05	6623.6	90.19	6.47	1.82	17.32	6630.1
III-5	187	548.72	0.05	6626.4	90.26	6.49	1.83	17.28	6632.9
III-6	187	548.46	0.05	6619.7	91.26	7.09	2.06	17.17	6626.7
Totals	3234	9487.14	0.97	116201.6	1576.82	110.17	30.63	303.26	116311.7
Pwr. II-1	302	741.39	0.11	15590.0	202.42	16.22	4.72	77.94	15606.3
Flat. II-2	303	743.51	0.11	15644.8	198.72	14.85	3.92	90.47	15659.7
Blkt. II-3	302	741.36	0.11	15588.4	192.90	13.25	3.44	95.46	15601.7
III-1	445	1092.25	0.17	23155.6	291.57	21.14	5.68	132.64	23176.7
III-2	445	1092.02	0.17	23131.0	305.97	26.29	7.57	117.14	23157.3
III-3	446	1094.47	0.17	23212.3	289.36	20.53	5.33	141.33	23232.9
III-4	446	1094.36	0.17	23197.7	310.19	27.32	7.93	112.01	23225.1
III-5	446	1094.55	0.17	23201.8	303.67	25.16	7.16	120.02	23227.0
III-6	446	1094.30	0.17	23210.8	295.43	22.61	6.00	136.16	23233.4
Totals	3581	8788.26	1.39	185932.6	2390.28	187.41	51.80	1023.23	186120.1
Core									
Totals	14243	23481.96	3.70	500575.4	6547.86	440.69	112.97	1900.53	501016.1
(Excluding Reflector)									

Table 3-12. Light Water Breeder Reactor fuel rod cladding material properties (Gorscak, Campbell, and Clayton 1987, WAPD-TM-1605, Table 3).

<u>Attribute</u>	<u>Seed</u>	<u>Standard Blanket</u>	<u>Power Flattening Blanket</u>	<u>Reflector</u>
Final Heat Treatment Temperature, degrees F	1225 ±25	925 ±25	925 ±25	925 ±25
Final Heat Treatment Time (hrs)	2 - 5	2 - 5	2 - 5	2 - 5
70 F Yield Strength (ksi)*	54.66 49.74	79.77 73.55	80.71 76.13	77.79 72.36
700 F Yield Strength (ksi)*	18.57 17.37	51.14 47.89	53.13 50.67	49.49 46.56
70 F Yield/Ult. Ratio*	1.472 1.405	1.363 1.310	1.359 1.330	1.367 1.330
700 F Yield/Ult. Ratio*	1.951 1.872	1.259 1.212	1.254 1.226	1.288 1.261
70 F Elongation (%)*	29.2 27.04	21.87 20.41	19.63 18.49	23.57 22.16
700 F Elongation (%)*	35.75 32.19	20.61 18.83	18.17 16.90	21.87 20.33

*Average and lower 95/95 tolerance interval

Table 3-13. As-built requirements for Light Water Breeder Reactor tubing (Eyler 1981, WAPD-TM-1289, Table A-2).

A. Nondestructive Inspections

1. Inside Diameter

a. Local

Type	Nominal*	Tolerance
Seed	0.262	± 0.0015
PFB	0.475	± 0.0020
Std. B.	0.516	± 0.0020
Refl.	0.748	± 0.0025

b. <u>Average (All)</u>	Nominal	± 0.0010
-------------------------	---------	----------

2. Outside Diameter-Local

Type	Nominal*	Tolerance*
Seed	0.3105	± 0.0020
PFB	0.5310	± 0.0020
Std. B.	0.5760	± 0.0020
Refl.	0.8350	± 0.0025

3. Wall Thickness

Type	Nominal*	Minimum*
Seed	0.0243	0.0225
PFB	0.0280	0.0260
Std.B.	0.0300	0.0280
Refl.	0.0435	0.0413

4. Wall Eccentricity-Maximum*

Type	Limits Per Purchase Order				Target Limit	Final LWBR Limit [#]	
	Initial Lots		Remaining Lots			Max	% of Nominal Wall Thickness
	No.	Limits	No.	Limit			
Seed	8	.0024	18	.0016	.0010	.0013	5.36
PFB	3	.0028	18	.0021	.0015	.0017	6.07
Std.B.	8	.0030	15	.0022	.0015	.0017	5.67
Refl.	All	.0035	-	-	.0022	.0022	5.06

*All dimensions are stated in inches.

#Limits achieved by additional inspection and/or sorting performed at Bettis.

Table 3-13. (continued).

5. Wavelength of Helical Wall Eccentricity

Type	Minimum*
Seed	
PFB	80
Std. B.	
Ref1.	70

6. Length

Type	Nominal*	Tolerance*
Seed	119	+0.5, -0.0
PFB	117	+0.5, -0.0
Std.B.	117	+0.5, -0.0
Ref1.	110.5	+0.5, -0.0
At Bettis	Fuel Rod Nominal	±0.015

7. Perpendicularity of End Face (at Bettis only)

All The deviation from perpendicularity to the OD surface of the end two inches shall be limited to 0.006 in/in.

8. Edge Squareness (at Bettis only)

All The maximum deviation from square edges as chamfer or rounding of the ID or OD edge of the end face shall not reduce the local wall thickness at the end face by more than 0.003 inch.

9. Straightness

All 0.010 inch maximum deflection (bow) of the tube from the center of a 15 inch chord (gage length).

* All dimensions are stated in inches.
 # Limits achieved by additional inspection and/or sorting performed at Bettis.

Table 3-13. (continued).

10. Internal Free Path

A right cylindrical plug (stainless steel) with an OD surface finish of 16 micro-inch AA or finer must pass freely through the full length of each finished tube as a last inspection prior to packing for shipment. The following plug sizes apply:

<u>Tube Type</u>	<u>Seed*</u>	<u>PFB*</u>	<u>Std.B.*</u>	<u>Ref1.*</u>
Nominal Tube ID	0.262	0.475	0.516	0.748
Plug OD				
Min	0.2585	0.4710	0.5120	0.7435
Max	0.2590	0.4715	0.5125	0.7440
Length of Plug (excluding end taper, tolerance is ± 0.005)				
Nominal	1.048	1.900	2.064	2.999
Nominal Fuel Pellet O.D. (tolerance is ± 0.0005)				
UO ₂ in ThO ₂	0.2520	0.4695	0.5105	0.7415
ThO ₂ only	0.2555	0.4695	0.5105	0.7415
Nominal Fuel Pellet Length (Reference)				
UO ₂ in ThO ₂	0.615	0.870	0.875	NA
ThO ₂ only	0.530	0.445	0.615	0.740

11. Visual Surface Inspection

The tubing OD and ID surfaces must be free of unacceptable surface conditions as determined by visual inspection. These unacceptable conditions include, but are not limited to, scratches, abrasions, nicks, dents, pits, holes, foreign material, and material defects (cracks, laps, seams, lamination, etc.).

12. Surface Finish

CONDITION: BRIGHT PICKLED
MAXIMUM SURFACE ROUGHNESS (MICROINCH A.A)

<u>Tube Type</u>	<u>O.D.</u>	<u>I.D.</u>
Seed		
Power Flattening Blanket	32	32
Standard Blanket		
Reflector	32	125

*All dimensions are stated in inches.

Table 3-13. (continued).

13. Material Quality

The tubing must be free of material and fabrication defects which exhibit a stronger response to the ultrasonic search beam than 80% of the response exhibited by the standard notches contained in the test calibration tube. The dimensions of the standard notch are shown below. Test sensitivity notches, half the depth of the standard notches must be reproducibly detected. All dimensions are in inches.

<u>Tube Type</u>	<u>Nom. Wall</u>	<u>Standard Defect Notch (Max)</u>		
		<u>Depth</u>	<u>Length</u>	<u>Width</u>
Seed	0.0242	0.0020	0.0200	0.003
PF Blanket	0.0280	0.0021	0.0210	0.003
Standard Blanket	0.0300	0.0022	0.0225	0.003
Reflector	0.0435	0.0032	0.0326	0.003

B. Destructive Testing

1. Chemistry

Compliance with the requirement for ingot composition (Table A-1) satisfies the basic chemistry requirements of the finished tubing. Samples from each lot of finished tubing must meet the limits noted for the five elements listed below.

<u>Elements</u>	<u>ppm Max.</u>	<u>ppm Min.</u>
Hydrogen	25	0
Nitrogen	80	0
Oxygen		
Individual Analysis	1800	900
Average from one ingot**		
Seed	1700	900
Blanket & Reflector	1600	900
Nickel	70	0
Hafnium	45	0

2. Surface Chemistry

Fluorine on ID surface in micrograms per square decimeter

Target 30 to 40
Alert 65

**Average of all finish tubing analyses from one ingot.

Table 3-13. (continued).

3. Corrosion Resistance

<u>Test Condition</u>	<u>Max. Weight Gain</u>
a. 14 days in 750°F steam at 1500 psig	38 mg/dm ²
b. 14 days in 680°F water at 2705 psig	28 mg/dm ² (preproduction only)

The corrosion tested tubing must exhibit a continuous lustrous, black, adherent, corrosion film consistent with established visual standards.

4. Longitudinal Uniaxial Tensile Properties

<u>Tube Type</u>	<u>(U/Y Ratio) (Min)^(a)</u>	<u>0.2% Offset Yield Strength (psi)</u>		<u>% Total Elongation (b)</u>
		<u>Min.</u>	<u>Max.</u>	
a. <u>Room Temperature</u>				
Seed	1.20	35,000	-	20.0
PF Blanket Standard Blanket Reflector	1.15	55,570	-	8.1
b. <u>700°F</u>				
Seed	1.5	15,500	30,000	20.0
PF Blanket Standard Blanket Reflector	1.15	43,500	69,500	8.1

5. Circumferential Tensile Properties (Burst Test)

<u>Tube Type</u>	<u>Minimum % Ductility at 700°F^(c)</u>
Seed	20
PF Blanket Standard Blanket Reflector	5

(a) Ratio of Ultimate Tensile Strength to 0.2% Offset Yield Strength

(b) Minimum in 2 inch gage length

(c) Percent increase in circumference of metallic portion of the bulge measured from fracture edge to fracture edge around the maximum circumference of the ruptured specimen.

Table 3-13. (continued).

6. Texture (Contractile Strain Ratio or CSR)

<u>Tube Type</u>	<u>Limits</u>	
	<u>Min.</u>	<u>Max.</u>
Seed		
PF Blanket	1.2	2.0
Std. Blanket		
Reflector	1.2	2.3

7. Hydride Orientation

The orientation of the zirconium hydride platelets (needles) in the finished tubing must be such that no more than the specified percent of the classifiable hydride needles are aligned within 30° of the radial direction (i.e., parallel to the tube radius).

	<u>Max. Individual Wall Segment Reading O.D., Middle, or I.D. Third of Wall Thickness</u>	<u>Max. Avg. of Three Segments For Each Sample</u>
Seed	50%	45%
Blanket & Reflector	30%	Not Applicable

8. Post-Anneal Cold Work

Seed (RXA)	3.0% Maximum
Blanket & Reflector (SRA)	Not Applicable

9. Grain Size

Seed	ASTM 9-12.5 (in the finished tubing)
Blanket & Reflector	ASTM 8-12.0 (at completion of the alpha recrystallization anneal prior to the last reduction)

10. Metallographic Inspection for Equiaxed Grains

Seed (RXA)	No distorted or non-equiaxed (non-recrystallized) grains permitted.
Blanket & Reflector (SRA)	There must be no evidence of recrystallization; i.e., there must be no equiaxed grains.

Table 3-13. (continued).

11. Metallographic Defects

All Tube Types

All metallographic inspections for hydride orientation, post anneal cold work, grain size, and equiaxed grains shall include an inspection for the presence of any defects exceeding 0.0040 inch in any dimension. Defects in excess of 0.0040 inch are not permitted.

C. Cold Work in Final Reduction

The amount of cold work (CW)^(*), or the reduction in cross-section area, in the last tube reduction shall be within the following ranges for the specified final heat treatment.

<u>Tube Type</u>	<u>Final Reduction</u>	<u>Final Heat Treatment (d)</u>
Seed	50 to 70%	RXA
PFB Std.B. Ref1.	60 to 80%	SRA

D. Final Heat Treatment

All tubes shall have a final heat treatment within the specified limits for the tube type. The size and placement of the load within the furnace, the mass in the furnace, and the furnace operating characteristics must be balanced such that the innermost (slowest heating) tube in the load receives the minimum heat treatment while the outermost (fastest heating) tube does not receive an excessive heat treatment. The prescribed heat treatment parameters for all LWBR tubes are shown in the following table.

<u>Final Heat Treatment (d)</u>	<u>Tube Type</u>	<u>Temperature (°F)</u>		<u>Hours Above Min. Temp.</u>	
		<u>Min.</u>	<u>Max.</u>	<u>Min.</u>	<u>Max.</u>
RXA	Seed	1200	1250	2	4.5
SRA	PF Blanket Standard Blanket Reflector	900	950	1	5.5

(*) The calculation is

$$\% CW = \frac{A-a}{A} \times 100 \text{ where:}$$

A = cross-section area before reduction
a = cross-section area after reduction

(d) RXA is recrystallization anneal and SRA is stress relief anneal.

3.3.3 Composition

Cladding consisted of Zircaloy-4 tubes with a low hafnium content (Hecker 1979, WAPD-TM-1326, p. 3). Neutron poisoning in zirconium was found to be attributed to the 2 to 3% of hafnium present in natural zirconium (Hecker and Freeman 1981, WAPD-TM-1409, p. 6). Zircaloy used for cladding and all other structures in the active fuel region except the fuel rod support grids had a low hafnium content (<50 ppm) (Campbell and Giovengo 1987, WAPD-TM-1387, p. 10). Ingot requirements for LWBR low hafnium Zircaloy-4 tubing are presented in Table 3-14. Stress corrosion cracking in zircaloy tubing is caused by pressure as low as 20,000 psi in the presence of controlled amounts of iodine gas at typical fuel rod operating temperatures. Normal yield strength of irradiated zircaloy is 40,000 to 60,000 psi. (Campbell and Giovengo 1987, WAPD-TM-1387, p. 51). Cladding fabrication is discussed in Eyster 1981 (WAPD-TM-1289).

3.3.4 Thickness

Wall thickness of each tube was measured over a spiral pattern as the tube rotated and advanced under the transducer station, which used a high frequency ultrasonic puls-echo measuring technique. Cladding wall thicknesses ranged from a minimum of 0.023 in. for the seed rods to a nominal 0.0435 in. for reflector rods (Table 3-13).

Table 3-14. Ingot requirements for Light Water Breeder Reactor Zircaloy-4 tubing (Eyler 1981, WAPD-TM-1289, Table A-1).

Zircaloy-4 Tubing

I. Alloy Chemistry[#]

<u>Element</u>	<u>Symbol</u>	<u>% Min.</u>	<u>% Max.</u>
Tin	Sn	1.20	1.70
Iron	Fe	0.18	0.24
Chromium	Cr	0.07	0.13
Oxygen	O	0.09	0.15
Iron + Chromium	-	0.28	0.37
Zirconium	Zr	Remainder	

II. Group A Impurity Limits

<u>Element</u>	<u>Symbol</u>	<u>ppm Max.</u>	<u>ASTM B-353-1977 ppm Max.⁺</u>
Aluminum	Al	75	
Boron	B	0.5	
Cadmium	Cd	0.5	
Carbon	C	270	
Cobalt	Co	20	
Copper	Cu	50	
Hafnium	Hf	35	100
Hydrogen	H	25	
Magnesium	Mg	15	20
Manganese	Mn	50	
Nickel	Ni	70	
Niobium	Nb	100	
Nitrogen	N	60	80
Silicon	Si	110	200
Tantalum	Ta	200	
Titanium	Ti	40	50
Tungsten	W	80	100
Uranium	U	3	3.5
Uranium Isotope	U-235	0.025	

Table 3-14. (continued).

III. Group B Impurity Limits[†]

<u>Element</u>	<u>Symbol</u>	<u>ppm Max.</u>	<u>ASTM B-353-1977 ppm Max.</u> [‡]
Chlorine	Cl*	15*	
Fluorine	F*	50*	
Gadolinium	Gd	5	
Lead	Pb	100	
Molybdenum	Mo	50	50
Phosphorus	P	50	
Samarium	Sm	10	
Thorium	Th	7	
Vanadium	V	50	
Zinc	Zn	100	

IV. Ingot Composition - Materials Source and Limits

<u>Source</u>	<u>Limits</u>
Sponge	50% min.
Solid Scrap	40% max.
Ingot Turnings	15% max.

V. Ingot Hardness - Brinell Hardness Number (BHN)

Test	10 mm ball, 3000 kg load
Limits	200 BHN max. individual 187 BHN max. average of 10 at room temperature

VI. Miscellaneous Tests

Ultrasonic Inspection
 Surface Finish
 Visual Inspection
 Magnetic Inspection

* For information only.

Identical to ASTM B-353-1977 (Ref. (c)). except as noted.

† Only specified in ASTM B-353-1977 as noted.

4. OPERATING HISTORY

Shippingport LWBR was operated for about 29,000 EFPH^a from September 1977 until October 1, 1982 (Budd 1986, WAPD-TM-1542, p. 1-9, and ICPP Fuel Receipt Criteria attached to WAPD-NRF(L)C-104, p.3). Average daily generator output as net electrical megawatts and reactor coolant temperature are presented in Figure 4-1 (Budd 1986, WAPD-TM-1542, Figure 1-1). The EFPH, number of hours the reactor was critical, and gross electrical output (in MWhr) are presented for the LWBR by quarter from 1977 to 1982 in Table 4-1.

During most of core life, the LWBR was operated as a base load station (Richardson et al. 1987, WAPD-TM-1606, p. 35). During the first two years of operation, the core was subjected to 204 planned swingload cycles to demonstrate the core transient capability and generating system load follow to simulate operation of a large commercial nuclear reactor (Richardson et al. 1987, WAPD-TM-1606, p. 35). A swing load cycle is defined as power reduction from about 90% to 35–60% for 4 to 8 hr, then back to 90% or higher power. Despite shutdowns and swing, the reactor achieved a high capacity factor of 65% and high availability factor of 86% (Richardson et al. 1987, WAPD-TM-1606, p. 35).

For its initial 18,000 EFPH, the maximum allowable reactor power was established as 72 MW gross (electric), and the average coolant temp was 531°F. Pressure was eventually reduced to 1,615 psia (Budd et al. 1986, WAPD-TM-1542, pp. 127-128). Table 4-2 identifies the operating temperatures and pressures for the LWBR operating life (Budd et al. 1986, WAPD-TM-1542, Table 4-1).

In the LWBR irradiation test program, two cladding defects occurred during planned power ramps. Both were hairline cracks attributed to stress corrosion cracking. Stress corrosion cracking was shown in laboratory tests on unfueled tubing specimens to occur at stress levels as low as 20,000 psi in the presence of controlled amounts of iodine gas at typical fuel rod operating temperatures (Campbell and Giovenco 1987, WAPD-TM-1387, p. 51).

The timeline for the LWBR reactor is presented in Table 4-3.

a. 1 EFPH is the equivalent of operating the core for one hour at rated power, namely, 236.6 MW (thermal).

YEAR: 1977

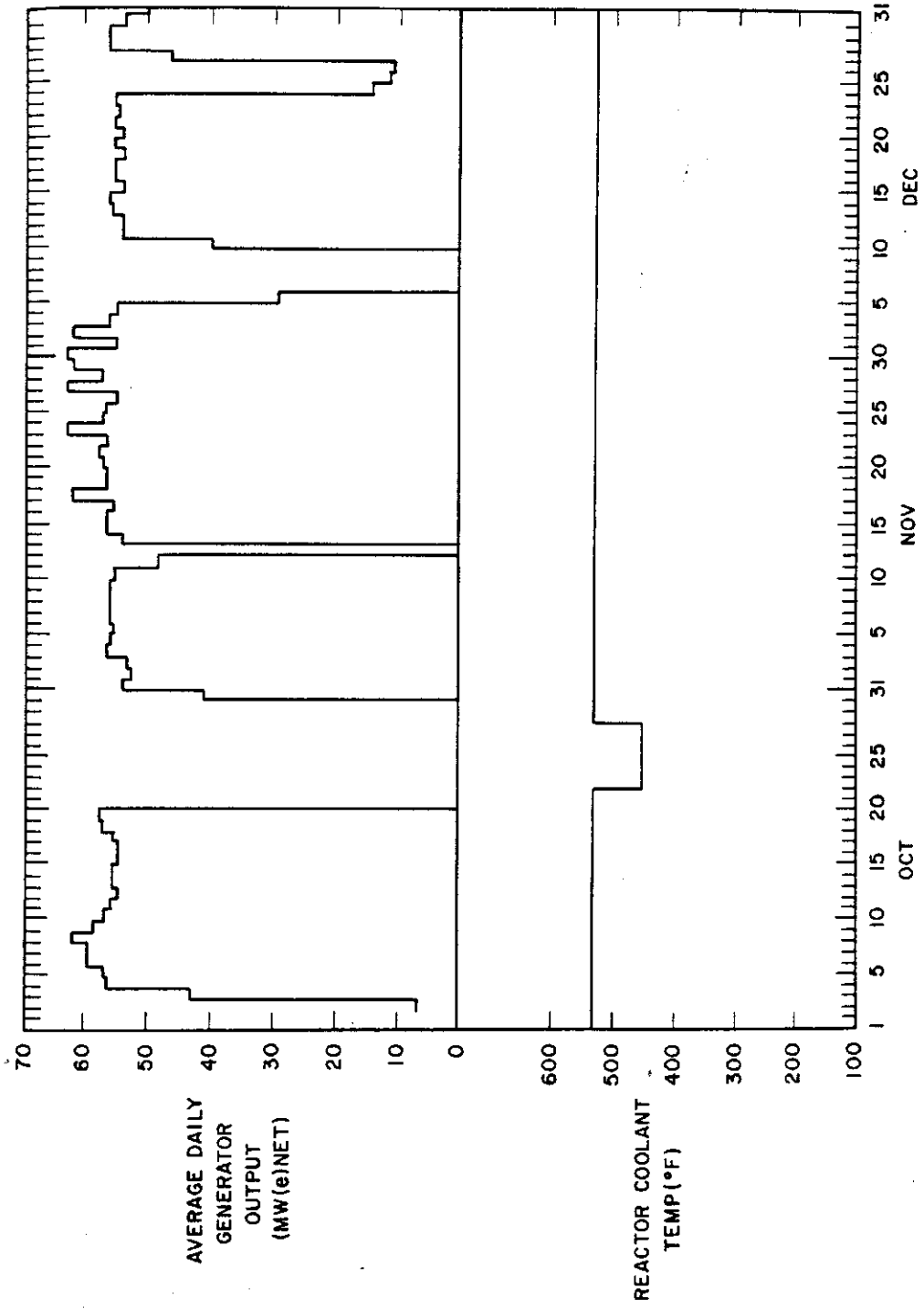

Figure 4-1. Light Water Breeder Reactor operational history, 1977 (Budd 1986, WAPD-TM-1542, Figure 1-1).

YEAR 1978

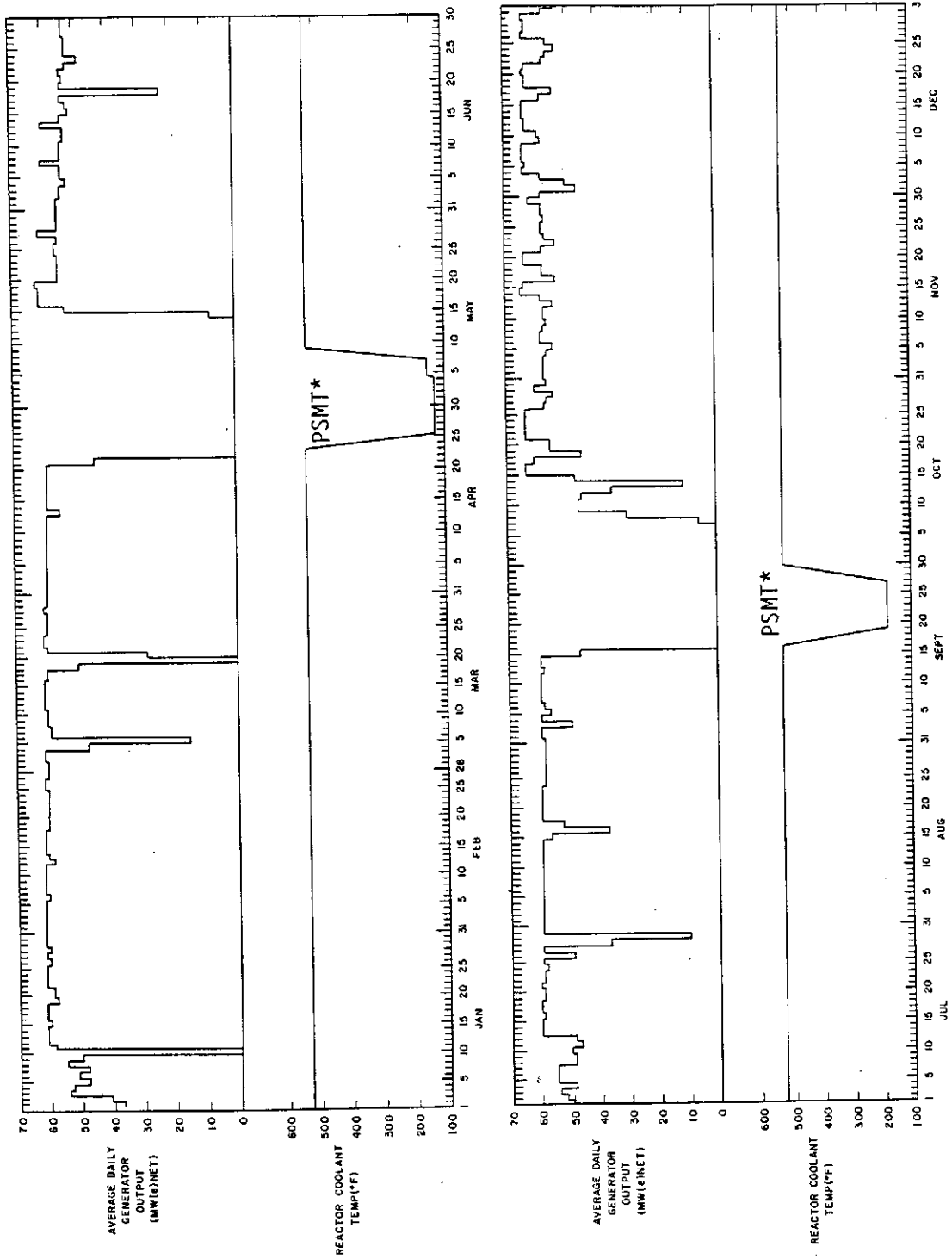

Figure 4-1. (continued.)

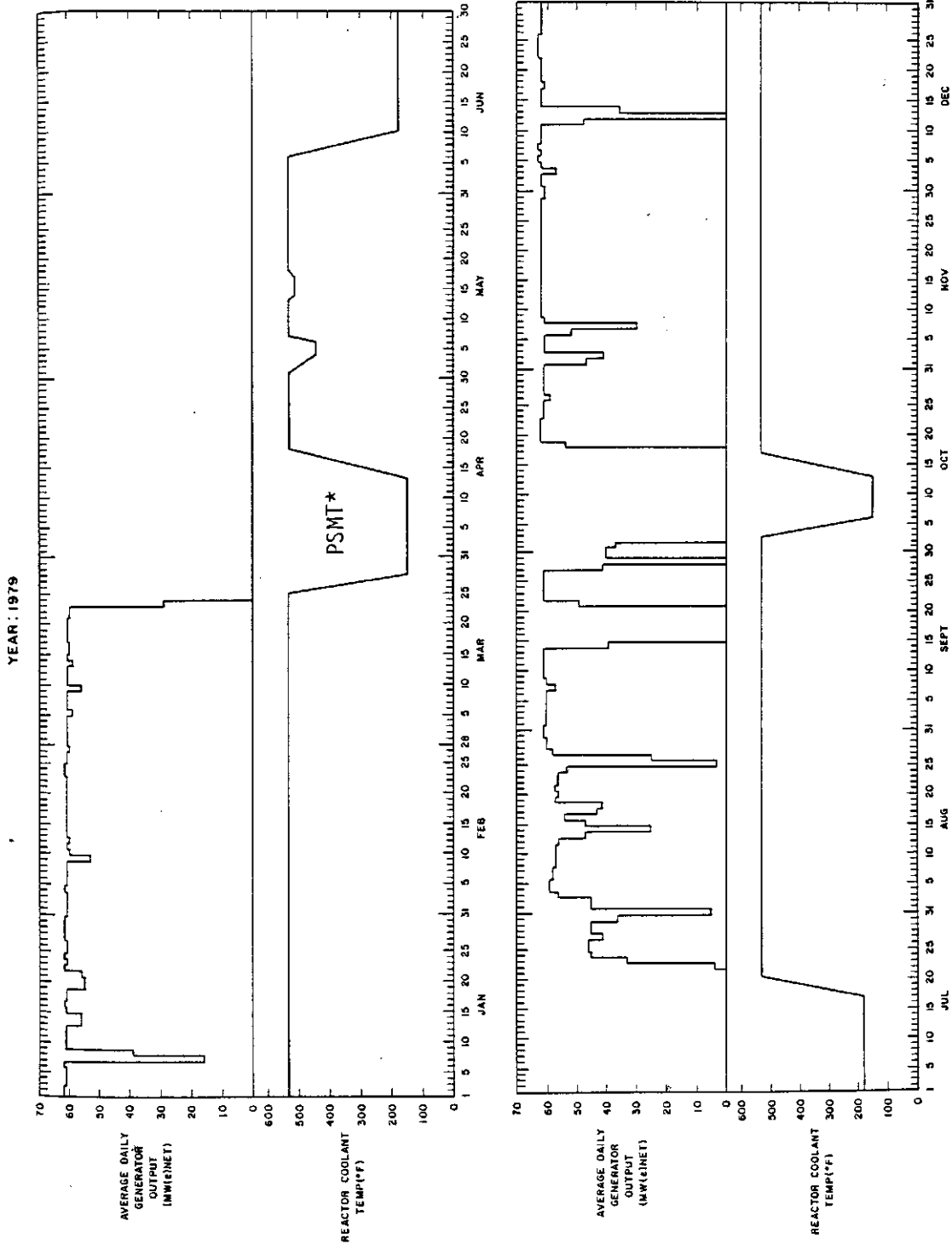

Figure 4-1. (continued).

YEAR: 1980

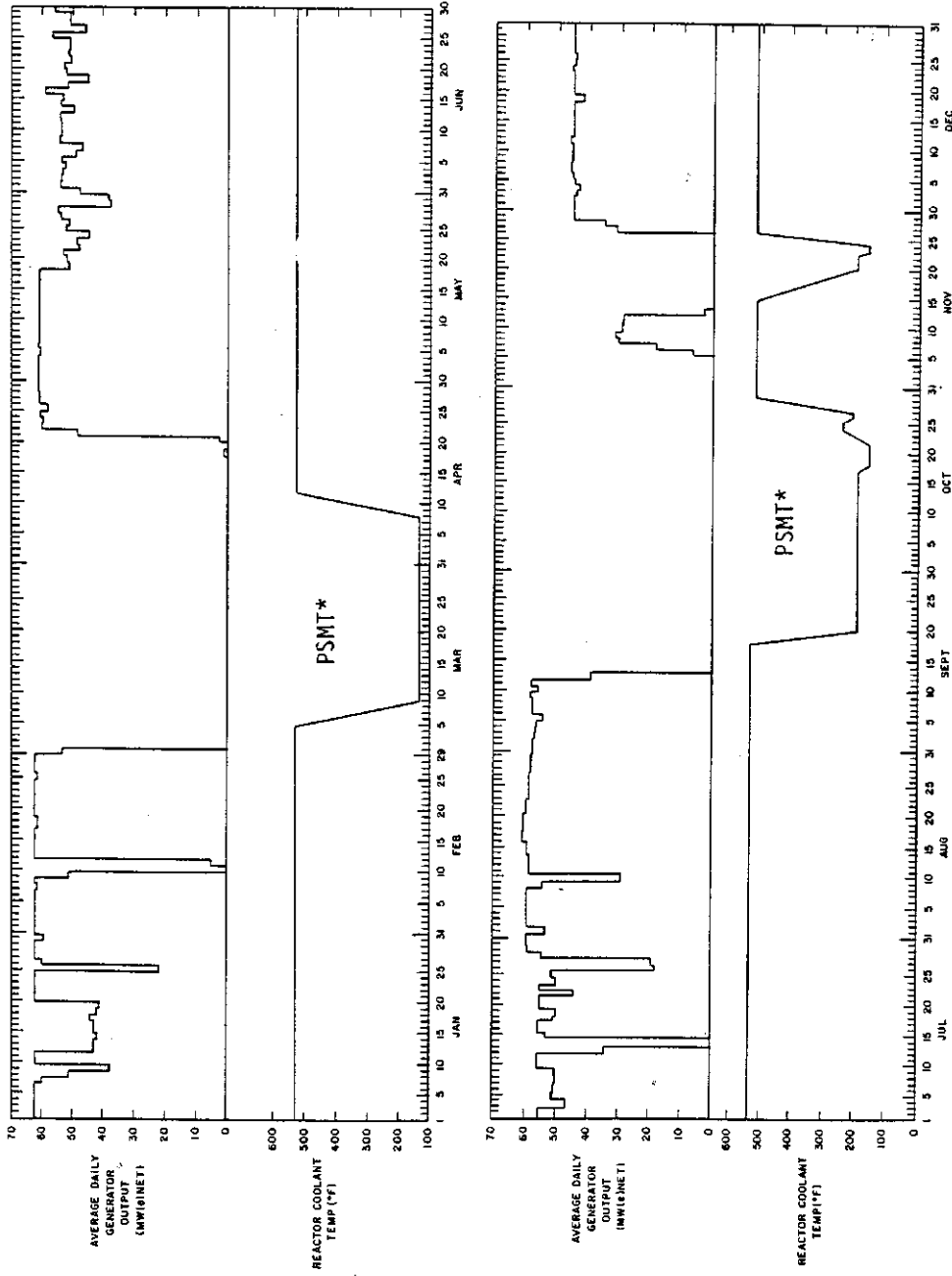

FIGURE 4-1. LWBR OPERATIONAL HISTORY (SHEET 4 OF 6) - 1980

Figure 4-1. (continued).

YEAR : 1981

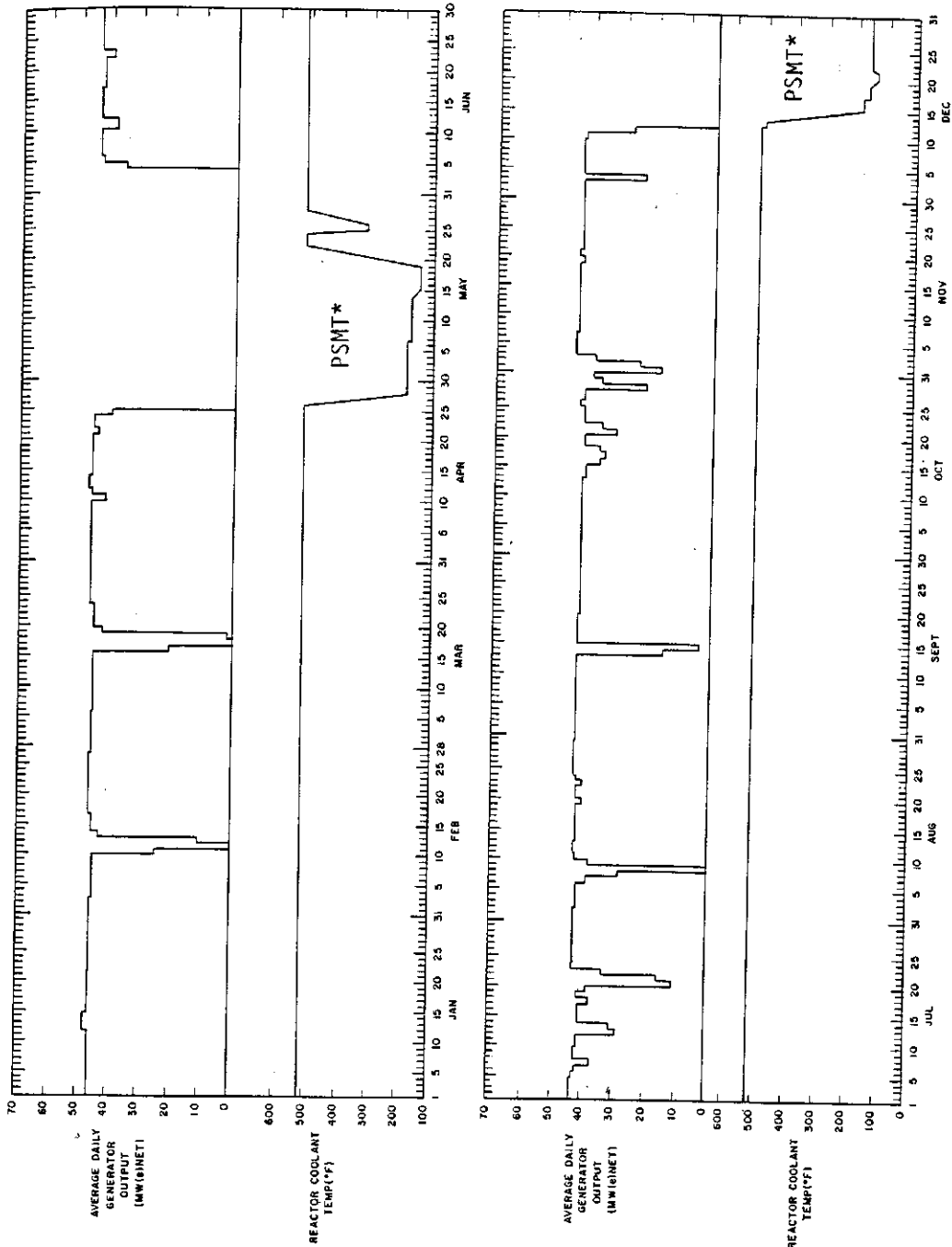
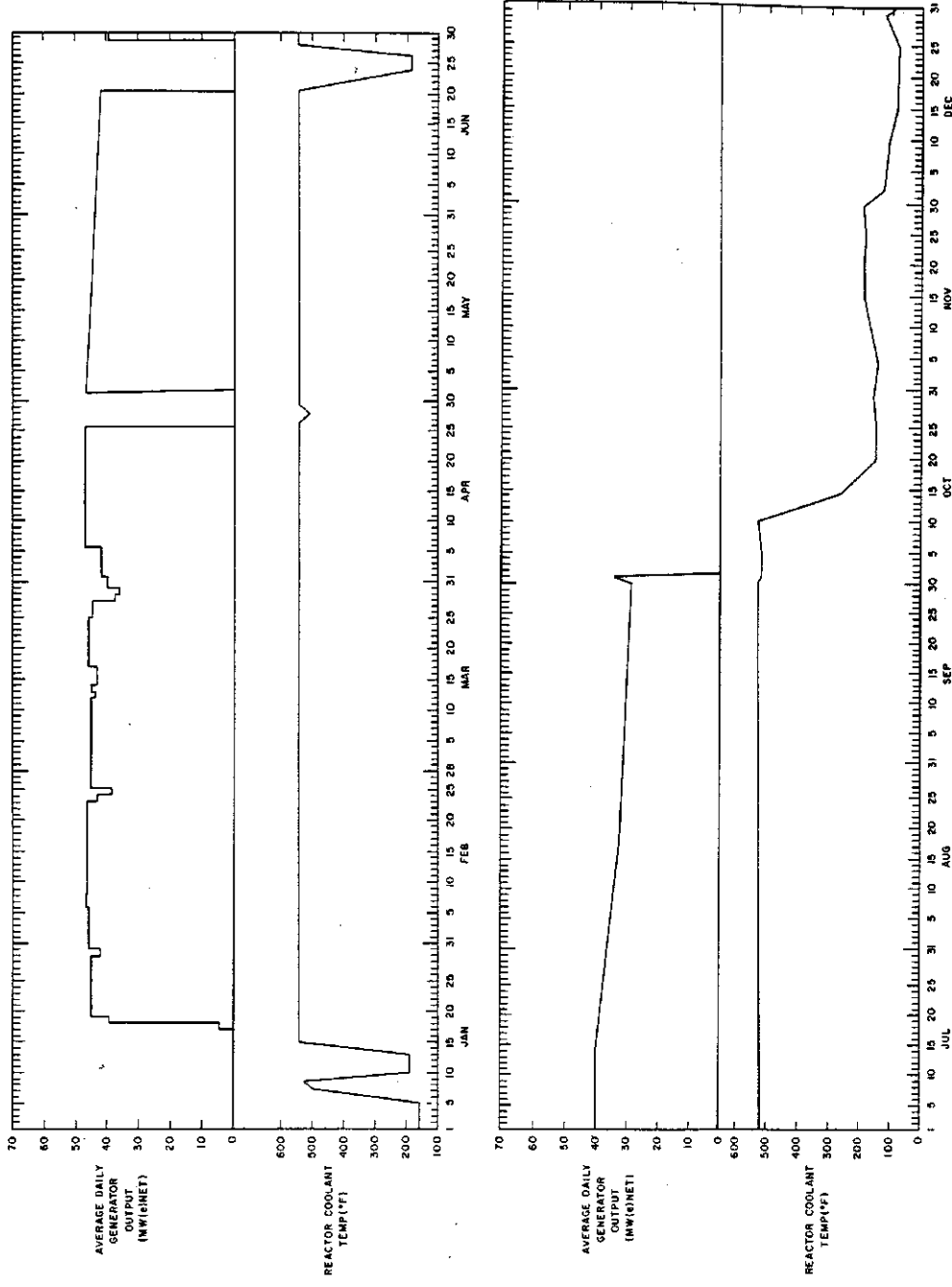

Figure 4-1. (continued).

YEAR : 1982



*PSMT = planned shutdown for maintenance and testing.

Figure 4-1. (continued).

Table 4-1. Summary of Light Water Breeder Reactor station performance (Budd 1986, WAPD-TM-1542, Table 1-1).

Year	Quarter	EFPH*		Hrs Reactor Critical		Gross Electrical Output
		This Quarter	To Date	This Quarter	To Date	Mwhr To Date
1977	3	270.4	270.4	641.9	641.9	17899
	4	1553.9	1824.3	1814.2	2456.1	134232
1978	1	2010.4	3834.7	2137.9	4594.0	283947
	2	1536.6	5371.3	1695.6	6289.6	396929
	3	1761.0	7132.3	1859.3	8148.9	523279
	4	1878.1	9010.4	2111.6	10260.5	662675
1979	1	1921.9	10932.3	1945.5	12206.0	805655
	2	0	10932.3	346.9	12552.9	805655
	3	1353.9	12286.2	1574.7	14127.6	903425
	4	1734.9	14021.1	1802.3	15929.9	1034503
1980	1	1304.6	15325.7	1415.4	17345.3	1133200
	2	1544.2	16869.9	1815.4	19160.7	1248104
	3	1636.8	18506.7	1782.1	20942.8	1366698
	4	757.7	19264.4	1213.3	22156.1	1423380
1981	1	1617.6	20882.0	2090.3	24246.4	1545038
	2	960.6	21842.6	1462.6	25713.0	1615465
	3	1649.5	23492.1	2151.9	27864.9	1731032
	4	1311.4	24803.5	1715.8	29580.7	1824592
1982	1	1355.7	26159.2	1807.6	31388.3	1923224
	2	1459.7	27618.9	1911.7	33300.0	2029313
	3	1422.8	29041.7	2208.0	35508.0	2128542
	4	5.7	29047.4	293.1	35801.1	2128943

*EFPH - Equivalent Full Power Hours [where full power is defined as 236.6 Megawatts thermal, Mw(t)]

Table 4-2. Summary of Light Water Breeder Reactor operating conditions (Budd 1986, WAPD-TM-1542, Table 4-1).

LWBR POWER OPERATING CONDITIONS

<u>Effective Date</u>	<u>Reactor Lifetime</u>	<u>Reactor Power Gross Electric</u>	<u>System Pressure</u>	<u>Average Coolant Temperature</u>
September 1977	0	72 MW	2000 psia	531°F
May 1978	4325 EFPH	72 MW	1940 psia	531°F
October 1978	7132 EFPH	72 MW	1870 psia	531°F
July 1979	10932 EFPH	72 MW	1815 psia	531°F
November 1980	18507 EFPH	58 MW	1615 psia	521°F
June to October 1982	27419 to 29047 EFPH	54 to 43 MW (in 12 steps)	1615 psia	521°F

Table 4-3. Timeline of events for the Light Water Breeder Reactor.

Reactor loading	1977
Initial criticality of core	Aug. 26, 1977 (Sarber 1983, WAPD-TM-1455 addendum, p. 3)
Full power operation	Sept. 21, 1977 (Sarber 1983, WAPD-TM-1455 addendum, p. 3)
Achieved depletion to 18,298 EFPH	Sept. 12, 1980 (Sarber 1983, WAPD-TM-1455 addendum, p. 3)
Operated at 80% of maximum, reduced temperature and pressure	Sept. 12, 1980 through Dec. 11, 1981 (18,298–24,451 EFPH) (Sarber 1983, WAPD-TM-1455 addendum, p. 3)
Maintenance and testing	21,094–24,541 EFPH
Reactor operation to 29,047 EFPH	1977–82
Reactor disassembly	Dec. 1982–Aug. 1984 (Selsley 1987c, WAPD-TM-1552, p. 7–9)
Shipping from Shippingport (10 shipments)	Sept. 1984 (Selsley 1987c, WAPD-TM-1552, p. 9)
Water pits S4-39 and N4-43 at Expended Core Facility for the majority of fuel disposal operations (Hodges 1987, WAPD-TM-1601, p. 1-4)	
Dismantling at Expended Core Facility 17 rods to Argonne National Lab-East 12 rods to Argonne National Lab-West	1984
Testing: Production Irradiated Fuel Assay Gauge	June 1984–May 1987 (Tessler et al. 1987, WAPD-TM-1614, p. 2).
Chronology of assay operations are provided in Table 24 (Tessler et al. 1987, WAPD-TM-1614, Table 4, p. 81)	
Repackaging at Expended Core Facility	
Shipping to Idaho Nuclear Technology and Engineering Center	1986–1987
Dry Storage at Idaho Nuclear Technology and Engineering Center	Current

5. FUEL EVALUATION

In order to verify both fuel and reactor performance, measured data were required to validate analytical models used to evaluate the LWBR burnup and breeding characteristics, as well as the reactor's physics parameters. A calculational model was developed to analyze the as-built core and predict the nuclear performance of the core prior to operation. The use of the U-233/Th fuel system led to the need for an extensive analysis of available cross section data and other basic nuclear data for U-233 and thorium, which had previously been given less attention than U-235 and U-238. The U-233 cross-section dependence on energy is particularly complex with broad resonances and strong multilevel effects. In addition, the U-233 cross section interferes with the thorium resonances and with the resonances of its own precursor Pa-233 (Freeman 1978, WAPD-TM-1314).

EOL destructive and nondestructive measurement data were used to compare with the calculational model results in order to verify and validate calculated breeding and burnup predictions.

5.1 End-of-Life Nondestructive and Destructive Examinations

The LWBR modules and rods were examined destructively and nondestructively to assess reactor and breeding performance. Examinations started in 1982 when the core was being removed from the reactor. At Shippingport, the modules were visually examined using an underwater closed circuit television camera, which verified that no indications of rough handling or other unusual conditions were present (WAPD-NRF(L)C-104 Fuel Receipt Criteria Part B 1987, p. 4). Following initial examination and loading, the modules were sent to ECF.

At ECF, 12 of the 39 core fuel modules were prepared for fuel rod removal: four seeds (SI-1, SII-3, SIII-1, and SIII-2), four blankets (BI-3, BII-2, BIII-2, and BIII-6) and four reflectors (RIV-3, RIV-4, RIV-9, and RV-4). Refer to Figure 5-1 for the locations of the removed modules in relation to the rest of the core. Both power-flattening and standard-type blanket rods were removed from the blanket modules. In all, more than 1000 rods were removed for testing and proof of breeding experiments. Of the 1,000+ rods, 524 were nondestructively evaluated at ECF using the Production Irradiated Fuel Assay Gauge (PIFAG) to measure rod EOL fertile and fissile thorium and uranium isotopic mass. To corroborate PIFAG measurements and obtain accurate data for the proof of breeding, 17 of the 524 PIFAG-analyzed rods were completely dissolved and assayed by ANL-E (Graczyk et al. 1987, ANL-87-2). Uranium isotopic data for each rod type are presented in Table 5-1, including destructive examination data (shaded), nondestructive examination data from the PIFAG (maximum assay results) and modeled beginning of life fissile content data. Information about the calculational model used to obtain the modeled data is presented in Freeman (1978)(WAPD-TM-1314). Information about nondestructive and destructive testing follows. An additional 12 PIFAG rods were destructively examined at ANL-W for fission gases.

5.1.1 Nondestructive Examinations

Nondestructive examinations were performed to confirm breeding, assess support structure and fuel rod performance, and provide a database for evaluation of design procedures (Table 5-2). The EOL examination program included examinations of entire modules as well as individual components (rods, grids, bolts, etc.) and crud examination (Table 5-3).

PIFAG. The PIFAG, discussed in Tessler et al. 1987 (WAPD-TM-1614), was used to nondestructively measure the fissile fuel content of 524 spent fuel rods from the modules. Cell locations of the 524 rods are shown in Figures 5-2 through 5-13. The 524 rods were selected using a statistical

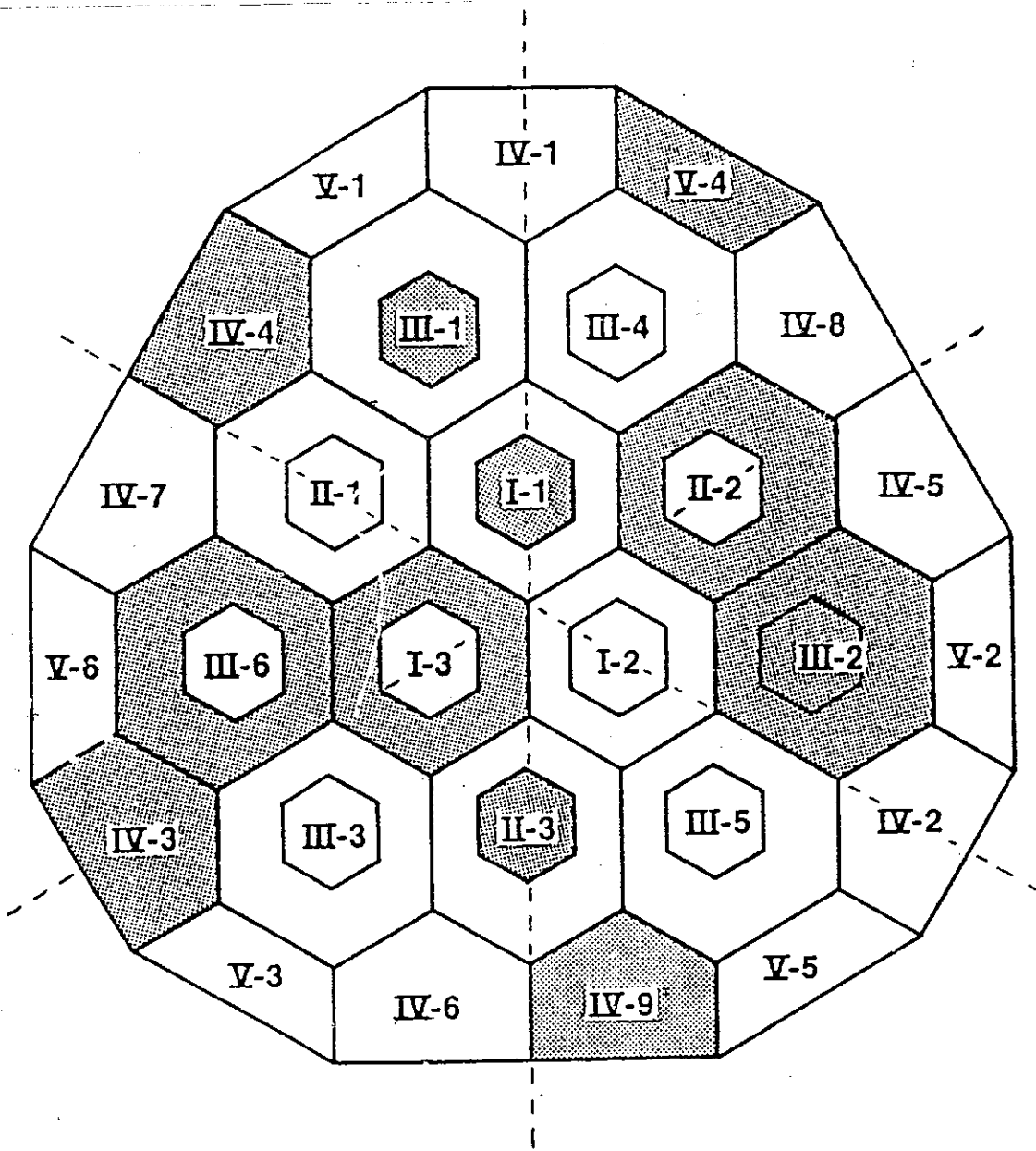

Figure 5-1. Diagram of Light Water Breeder Reactor core, showing locations of Proof-of-Breeding modules (shaded) and boundaries of Sixth-Core Sectors (dashed) (Schick et al. 1987, WAPD-TM-1612, Figure V-1).

Table 5-1. Modeled and measured end-of-life (EOL) isotopic content of Light Water Breeder Reactor fuel rods (from Fuel Receipt Criteria Part B information and ANL-E unpublished data).

Rod Type	Module Type (cell)	Th-232 ^a (g)	U-232 ^a (g)	U-233 ^a (g)	U-234 ^a (g)	U-235 ^a (g)	U-236 ^a (g)	U-238 ^a (g)	Maximum BOL Fissile ^b (Modeled) (g)	Maximum EOL Fissile (Measured) ^c (g)
1,2,7,8	SI-1	0.7	0.03	13.69	1.67	0.29	0.03	0.03	14.35	14.23
	SI-1 (P39) ^d		0.02	13.57	1.69	0.29	0.03	0.04	14.22	13.99
	SII-3	0.71	0.02	13.75	1.48	0.23	0.02	0.03	14.37	14.27
	SIII-1	0.71	0.02	13.82	1.32	0.19	0.02	0.03	14.33	14.32
	SIII-2	0.71	0.02	13.82	1.32	0.19	0.02	0.03	14.45	14.38
3	SI-1	0.7	0.03	15.29	1.89	0.33	0.03	0.04	19.18	15.68
	SI-1 (N63) ^d		0.02	15.3	1.88	0.34	0.04	0.05	19.18	15.68
	SII-3	0.7	0.03	15.6	1.7	0.28	0.02	0.04	19.15	15.77
	SIII-1	0.7	0.02	15.88	1.53	0.23	0.02	0.04	19.14	15.98
	SIII-2	0.7	0.02	15.88	1.53	0.23	0.02	0.04	19.19	16.44
4	SI-1	0.69	0.03	17.17	2.13	0.38	0.04	0.05	23.90	17.52
	SI-1 (M49) ^d		0.02	17.06	2.12	0.37	0.03	0.07	23.70	17.52
	SII-3	0.69	0.03	17.72	1.93	0.31	0.03	0.05	24.03	18.06
	SIII-1	0.69	0.02	18.24	1.76	0.26	0.02	0.05	23.90	18.77
	SIII-2	0.69	0.02	18.24	1.76	0.26	0.02	0.05	23.98	18.92
5,6	SI-1	0.68	0.03	24.34	2.54	0.41	0.03	0.07	34.74	25.71
	SI-1 (L29) ^d		0.02	22.33	2.74	0.46	0.04	0.08	34.60	22.96
	SI-1 (C10) ^d		0.02	25.15	2.51	0.4	0.03	0.08	34.68	25.67
	SII-3	0.68	0.03	25.37	2.31	0.35	0.03	0.07	34.87	26.88
	SIII-1	0.68	0.02	26.28	2.1	0.29	0.02	0.07	34.74	27.67
	SIII-2	0.68	0.02	26.28	2.1	0.29	0.02	0.07	34.84	27.58
11,12	BI-3	2.9	0.1	35.4	3.25	0.54	0.05	0.03	16.50	36.88
	BI-3 (A49) ^d		0.08	35.9	3.87	0.7	0.07	0.04	16.45	36.88
	BII-2	2.9	0.09	34.3	2.98	0.47	0.04	0.03	16.48	36.10
	BIII-2	2.91	0.08	33.3	2.73	0.41	0.03	0.03	16.48	34.11
	BIII-6	2.91	0.08	33.3	2.73	0.41	0.03	0.03	16.51	34.72
13	BI-3	2.87	0.1	47.2	4.42	0.74	0.06	0.08	45.53	47.75
	BI-3 (D24) ^d		0.06	46.43	4.35	0.73	0.07	0.1	45.46	47.38
	BII-2	2.87	0.09	46.87	4.22	0.68	0.06	0.08	45.52	47.68
	BIII-2	2.87	0.08	46.59	4.02	0.63	0.05	0.08	45.56	47.25
	BIII-6	2.87	0.08	46.59	4.02	0.63	0.05	0.08	45.58	47.07

Table 5-1. (continued).

Rod Type	Module Type (cell)	Th-232 ^a (g)	U-232 ^a (g)	U-233 ^a (g)	U-234 ^a (g)	U-235 ^a (g)	U-236 ^a (g)	U-238 ^a (g)	Maximum BOL Fissile ^b (Modeled) (g)	Maximum EOL Fissile (Measured) ^c (g)
14	BI-3	2.92	0.09	40.74	3.63	0.61	0.05	0.06	30.67	41.35
	BI-3 (C3) ^d		0.06	40.03	3.59	0.58	0.04	0.07	30.67	40.76
	BII-2	2.92	0.09	40.74	3.63	0.61	0.05	0.06	30.61	40.96
	BIII-2	2.92	0.08	39.4	3.21	0.5	0.04	0.06	30.64	39.89
	BIII-6	2.92	0.08	39.4	3.21	0.5	0.04	0.06	30.71	39.89
15	BI-3	2.88	0.1	47.04	4.66	0.76	0.07	0.09	45.84	48.78
	BII-2	2.88	0.1	46.88	4.5	0.72	0.06	0.09	45.75	48.45
	BIII-2	2.88	0.09	46.71	4.29	0.67	0.06	0.09	45.74	48.23
	BIII-6	2.88	0.09	46.71	4.29	0.67	0.06	0.09	45.76	48.21
16	BI-3	2.89	0.1	52.19	4.92	0.8	0.07	0.1	54.75	52.81
	BI-3 (E56) ^d		0.07	51.41	5.23	0.88	0.08	0.12	54.55	52.51
	BII-2	2.89	0.09	52.1	4.74	0.75	0.07	0.1	54.86	52.88
	BIII-2	2.9	0.09	52.06	4.53	0.7	0.06	0.1	54.67	52.74
	BIII-6	2.9	0.09	52.06	4.53	0.7	0.06	0.1	54.70	52.64
21,22	BII-2	2.45	0.06	30.09	2.67	0.4	0.03	0.04	19.00	31.14
	BIII-2	2.45	0.05	28.98	2.29	0.31	0.02	0.04	18.99	30.55
	BIII-6	2.45	0.05	28.98	2.29	0.31	0.02	0.04	19.00	30.39
	BIII-6 (B62) ^d		0.04	28.91	2.27	0.32	0.03	0.05	19.00	29.37
23	BII-2	2.42	0.06	45.57	3.95	0.57	0.05	0.22	52.79	46.03
	BIII-2	2.42	0.05	46.13	3.53	0.47	0.04	0.22	52.77	46.86
	BIII-6	2.42	0.05	46.13	3.53	0.47	0.04	0.22	52.55	46.71
	BIII-6 (D29) ^d		0.05	44.45	4.4	0.71	0.08	0.12	52.51	45.36
24	BII-2	2.46	0.06	34.68	2.98	0.45	0.04	0.06	30.77	35.29
	BIII-2	2.46	0.05	34.11	2.62	0.37	0.03	0.06	30.88	34.49
	BIII-6	2.46	0.05	34.11	2.62	0.37	0.03	0.06	30.80	34.89
	BIII-6 (C13) ^d		0.02	33.61	2.21	0.28	0.02	0.08	30.78	34.02
25,26	BII-2	2.43	0.05	53.87	3.78	0.47	0.04	0.26	63.39	56.60
	BIII-2	2.43	0.03	55.13	3.3	0.38	0.03	0.26	63.18	57.41
	BIII-6	2.43	0.03	55.13	3.3	0.38	0.03	0.26	63.45	57.53
	BIII-6 (F73) ^d		0.04	53.07	4.27	0.62	0.07	0.15	63.27	53.75
	BIII-6 (H1) ^d		0.01	57.1	2.51	0.23	0.01	0.46	63.00	57.44
	BIII-6 (E31) ^d		0.05	50.7	4.94	0.78	0.09	0.15	63.12	51.62

Table 5-1. (continued).

Rod Type	Module Type (cell)	Th-232 ^a (g)	U-232 ^a (g)	U-233 ^a (g)	U-234 ^a (g)	U-235 ^a (g)	U-236 ^a (g)	U-238 ^a (g)	Maximum BOL Fissile ^b (Modeled) (g)	Maximum EOL Fissile (Measured) ^c (g)
27	BII-2	2.42	0.07	41.72	4.14	0.64	0.06	0.09	46.53	42.75
	BIII-2	2.42	0.07	41.78	4.04	0.62	0.06	0.09	46.37	43.14
	BIII-6	2.42	0.07	41.78	4.04	0.62	0.06	0.09	46.56	42.88
Reflector POB Cat 43 ^e	RIV-3	6.09	0.00	4.54	0.03	0.00	0.00	0.00	0.00	37.45
POB Cat 44 ^e	RIV-3	6.09	0.00	9.36	0.10	0.00	0.00	0.00	0.00	
POB Cat 45 ^e	RIV-3	6.08	0.01	15.31	0.28	0.01	0.00	0.00	0.00	
POB Cat 46 ^e	RIV-3	6.08	0.02	22.42	0.59	0.04	0.00	0.00	0.00	
POB Cat 47 ^e	RIV-3	6.04	0.04	30.97	1.12	0.09	0.00	0.00	0.00	
	RIV-3 (B1) ^c		0.04	34.63	1.49	0.14	0.005	0.002	0.00	34.93
	RIV-3 (E3) ^c		0.01	23.68	0.68	0.04	0.001	0.002	0.00	23.87
POB Cat 38 ^e	RIV-4, RIV-9	6.09	0.00	4.99	0.03	0.00	0.00	0.00	0.00	39.34
POB Cat 39 ^e	RIV-4, RIV-9	6.09	0.00	10.34	0.13	0.00	0.00	0.00	0.00	39.69
POB Cat 40 ^e	RIV-4, RIV-9	6.08	0.01	16.57	0.32	0.01	0.00	0.00	0.00	
POB Cat 41 ^e	RIV-4, RIV-9	6.07	0.02	23.53	0.65	0.04	0.00	0.00	0.00	
POB Cat 42 ^e	RIV-4, RIV-9	6.04	0.04	32.39	1.22	0.10	0.00	0.00	0.00	
POB Cat 48 ^e	RV-4	6.09	0.00	4.80	0.03	0.00	0.00	0.00	0.00	24.20
POB Cat 49 ^e	RV-4	6.09	0.00	10.46	0.12	0.00	0.00	0.00	0.00	
POB Cat 50 ^e	RV-4	6.07	0.01	19.14	0.42	0.02	0.00	0.00	0.00	

a. Isotopic data taken from Part B Fuel Receipt Criteria EOL fuel loading data for the rod storage liners. Shaded cells contain results from the unpublished ANL-E destructive examinations.

b. Maximum as-built loading (modeled) for the rod type as reported in Tessler et al. (1987) WAPD-TM-1614, Tables 26–40.

c. Maximum EOL fissile for the rod type measured with the PIFAG, as reported in Tessler et al. (1987) WAPD-TM-1614, Tables 26–40.

d. The number in parentheses is the location of the cell within the module, which held the rod that was destructively examined by ANL-E.

e. POB Cat is the Proof of Breeding category assigned to the fuel rods within the reflector modules.

Table 5-2. Summary of nondestructive examinations.

Test	Purpose	Number of Samples	Results	Location of Test
Fuel module visual examinations	Assess module condition immediately after being removed from reactor (crud, corrosion, damage, deformation of modules)	All before shipping from Shippingport 5 seed, 5 blanket, 3 reflector modules at Expanded Core Facility (ECF)	Seal blocks and stub tubes clean, crud on reflector modules, but otherwise in excellent condition (Wargo 1987, WAPD-TM-1602, pp. 18-27)	Shippingport APS, ECF
Fuel module bow and growth	Measure module bow and growth	Seed: 5 modules Blanket: 5 modules Reflector: 3 modules	Minimal growth and bow. Module bowing: Seed: 0.01 to 0.053 in. Blanket: 0.029 to 0.098 in. Reflector: 0.236 to 0.239 in. (Wargo 1987, WAPD-TM-1602, pp. 18-27)	ECF water pits
Production Irradiated Fuel Assay Gauge (PIFAG) (active neutron interrogation and delayed neutron counting)	Fissile fuel content, proof-of-breeding	524 rods from 12 modules (Figures 5-2 through 5-13)	Results are reproduced in Appendix A.	ECF hot cells
Gamma scan (PIFAG)	Measure in-stack gaps, binary fuel stack lengths, and axial profiles	24 rods: 9 seed 8 standard blanket 4 power-flattening blanket 3 reflector	No in-stack gaps between pellets noted with gamma scan (Gorscak, Campbell, and Clayton 1987, WAPD-TM-1605, p. 182). Resolution 0.2 in. Maximum binary fuel elongation: Seed: 0.722 in. Blanket: 0.541 in. (Gorscak, Campbell, and Clayton 1987, WAPD-TM-1605, Table 27).	ECF hot cells

Table 5-2. (continued).

Test	Purpose	Number of Samples	Results	Location of Test
Rod pull force measurements (Rod Removal System [RRS])	Prevent overstressing a rod during disassembly, measure residual spring forces in support grids	1072 (test rods and rods for accessing test rods)	Upper 95% tolerance limit and maximum pull forces: Seed: 29 lb/90 lb Blanket: 52 lb/96 lb Reflector: 56 lb/145 lb (Gorscak, Campbell, and Clayton 1987, WAPD-TM-1605, Figures 14-16, Table 9).	ECF
In-bundle bow and gap measurements (Vertical Inspection Gage Inspection Package) underwater	For Nuclear Regulatory Commission core certification safety analysis, standard deviations of percent gap closure required (Campbell, and Clayton 1987, p. 39). Fuel rod performance	1 seed 5 blankets 1 reflector (see Gorscak, Campbell, and Clayton 1987, WAPD-TM-1605, Figure 7)	Module bowing: SII-3: 0.03 in. BIII-2: 0.095 in. RIV-4: 0.160 in. (Gorscak, Campbell, and Clayton 1987, WAPD-TM-1605, p. 72). Other results in App. A4 and A5, Figures 21-30 in Gorscak, Campbell, and Clayton 1987, WAPD-TM-1605.	Bettis
Rod length (Rod Examination [REX] Gauge)	Evaluate in-reactor length increases from thermal expansion, system pressure, irradiation growth of zircaloy cladding, and pellet-cladding interaction.	6 seed 5 standard blanket 5 power-flattening blanket 3 reflector	Elongation about 0.3-0.6 inches for all types (Gorscak, Campbell, and Clayton 1987, WAPD-TM-1605, Table 10).	ECF
Visual inspections (REX, underwater camera)	Cladding cracking and collapse	Almost 1100 from 12 modules	Usual wear. No evidence of gross cladding deformation, cracked cladding, excessive wear, or any other unusual conditions (Gorscak, Campbell, and Clayton 1987, WAPD-TM-1605, pp. 98-99). Negligible post-transition oxide.	ECF

Table 5-2. (continued).

Test	Purpose	Number of Samples	Results	Location of Test
Free hanging bow (REX, 5X video recordings at 0, 45, 90, and 135-degree orientations)	Calculate seeding force and beginning-of-life bow of each rod	5 seed 4 standard blanket 3 power-flattening blanket 3 reflector	Free hanging bow measurements indicate an EOL maximum of 0.291 in. in a reflector rod (Gorscak, Campbell and Clayton 1987, WAPD-TM-1605, p. 109, Table 13). Calculated end-of-life in-bundle span bows from free hanging bow data were significantly smaller than worst-case bow predictions except for span 7 of seed rod 1606710 (Gorscak, Campbell, and Clayton 1987, WAPD-TM-1605, p. 110, data in Table 14).	ECF
Cladding diameter and in-stack ovality measurements (REX axial profilometer; cladding outside diameters measured at 0, 45, 90 and 135-degree orientation)	Evaluate fuel rod ridging, grooving, ovality	19 rods	Diameter shrinkage and ovality less than predicted (see Gorscak, Campbell, and Clayton 1987, WAPD-TM-1605, Figures 44-46 and Table 15). Shrinkage 1-6 mils.	ECF
Plenum ovality (REX)	To confirm stability of the freestanding recrystallization annealed cladding in the seeds and confirm predictions of cladding deformation for nonfreestanding stress relief annealed blanket cladding (p. 47)	4 seed 7 standard blanket 3 power-flattening blanket	Ovalities <2 mils for seed rods and <4 mils for blanket rods (Gorscak, Campbell, and Clayton 1987, WAPD-TM-1605, Table 17).	ECF

Table 5-2. (continued).

Test	Purpose	Number of Samples	Results	Location of Test
Wear mark depth volume and location (REX orbiting profilometer)	Confirm fuel rod design analysis procedure for rod wear; overall view of rod wear for grid support system	4 seed 7 standard blanket 3 power-flattening blanket	Wear marks virtually nonexistent (Gorscak, Campbell, and Clayton 1987, WAPD-TM-1605, p. 128).	ECF
Oxide thickness (Nortec 5 MHZ eddy current oxide thickness, EDCOT, gauge in the axial profilometer)	Axial variations of oxide thickness	12 destructive examination rods + 4 others	Oxide thickness <0.2 mil over the bottom 30 in. of each rod. Peak of 1.46 mils near the seventh grid level in rod 400736, which coincides with top of binary stack; peak of 1.56 mils between 6th and 7th levels in 606773 (Gorscak, Campbell, and Clayton 1987, WAPD-TM-1605, Table 19).	ECF
Cladding defects (REX ultrasonic gauge)	Determine if cracks formed as a result of core operation and to locate defect indications (Gorscak, Campbell, and Clayton 1987, WAPD-TM-1605, p. 54)	12 destructive examination (Gorscak, Campbell, and Clayton 1987, WAPD-TM-1605, p. 147)	No indications of significant defects through-cladding cracks or other unusual conditions in 9 of the 12 rods. 1 standard blanket and 2 power-flattening blanket rods had strong ultrasonic examination indications (>10 mils) that were not surface marks and not confirmable with metallographic analysis (Gorscak, Campbell, and Clayton 1987, WAPD-TM-1605, p. 147).	ECF
Crud measurements (decrud with four solutions then quantitative analysis)	Characterize crud deposits on the external surface including elements and radioisotopes in crud.	Seed 0504502 Standard blanket 1605629 Reflector 3220018	Characteristics of crud shown in Table 5-3. Local smudge-like areas of crud were frequently observed on the rods. Descaling was largely effective (Gorscak, Campbell, and Clayton 1987, WAPD-TM-1605, p. 152).	Argonne National Laboratory - West

Table 5-2. (continued).

Test	Purpose	Number of Samples	Results	Location of Test
Neutron radiography	For proper cutting of rods, examining fuel pellet integrity, and determining fuel stack and plenum dimensions in the intact fuel rods.	<p>12 destructive examination rods:</p> <ul style="list-style-type: none"> 4 seed (2 with 84-in. binary stack length, 1 with 70-in. binary stack length, 1 with 42-in. binary stack length). 4 standard blanket (2 with 42-in. binary stack length, 1 with 84-in. binary stack and high enrichment, and 1 with 84-in. binary stack length and medium enrichment) 3 power-flattening blanket (84 in. with high enrichment) 1 reflector 	None of the radiographs gave an indication of defected cladding or massive hydriding. (Gorscak, Campbell, and Clayton 1987, WAPD-TM-1605, p. 164). Pellet stacks were generally stable and continuous. Most pellet cracks were hairline; few indicate fuel separation.	Argonne National Laboratory-West Neutron Radiography Facility

Table 5-3. Fuel rod crud characterization (Gorscak, Campbell, and Clayton 1987, WAPD-TM-1605, Table 21).

Seed Rod 0504502

Elements (mg/dm ²)					
<u>Increment</u>	<u>Fe</u>	<u>Ni</u>	<u>Cr</u>	<u>Co</u>	<u>Cu</u>
First	0.38	0.45	0.10	nd*	nd*
Second	0.26	0.26	0.03	nd*	nd*
Third	0.54	0.88	0.08	nd*	nd*
Radioisotopes (μCi/dm ²)					
<u>Increment</u>	⁵⁵ Fe	⁶³ Ni	⁶⁰ Co	⁵⁴ Mn	¹²⁵ Sb
First	3.87	3.45	10.21	7.74	nd*
Second	3.54	1.70	15.21	5.76	nd*
Third	5.23	1.95	26.87	6.54	trace

Blanket Rod 1605629

Elements (mg/dm ²)					
<u>Increment</u>	<u>Fe</u>	<u>Ni</u>	<u>Cr</u>	<u>Co</u>	<u>Cu</u>
First	0.48	0.39	0.08	nd*	nd*
Second	0.73	0.56	0.04	nd*	nd*
Third	2.02	0.86	0.09	nd*	nd*
Radioisotopes (μCi/dm ²)					
<u>Increment</u>	⁵⁵ Fe	⁶³ Ni	⁶⁰ Co	⁵⁴ Mn	¹²⁵ Sb
First	3.02	1.91	12.68	3.30	nd*
Second	8.52	5.57	42.61	7.10	nd*
Third	13.83	4.18	62.76	5.81	trace

Reflector Rod 3220018

Elements (mg/dm ²)					
<u>Increment</u>	<u>Fe</u>	<u>Ni</u>	<u>Cr</u>	<u>Co</u>	<u>Cu</u>
First	0.49	0.47	0.04	nd*	nd*
Second	0.34	0.86	0.04	nd*	nd*
Third	0.40	0.04	0.04	nd*	nd*
Radioisotopes (μCi/dm ²)					
<u>Increment</u>	⁵⁵ Fe	⁶³ Ni	⁶⁰ Co	⁵⁴ Mn	¹²⁵ Sb
First	2.03	1.48	2.61	3.47	nd*
Second	4.58	5.08	9.66	2.69	nd*
Third	2.16	0.73	5.13	nd*	nd*

*nd - not discernible

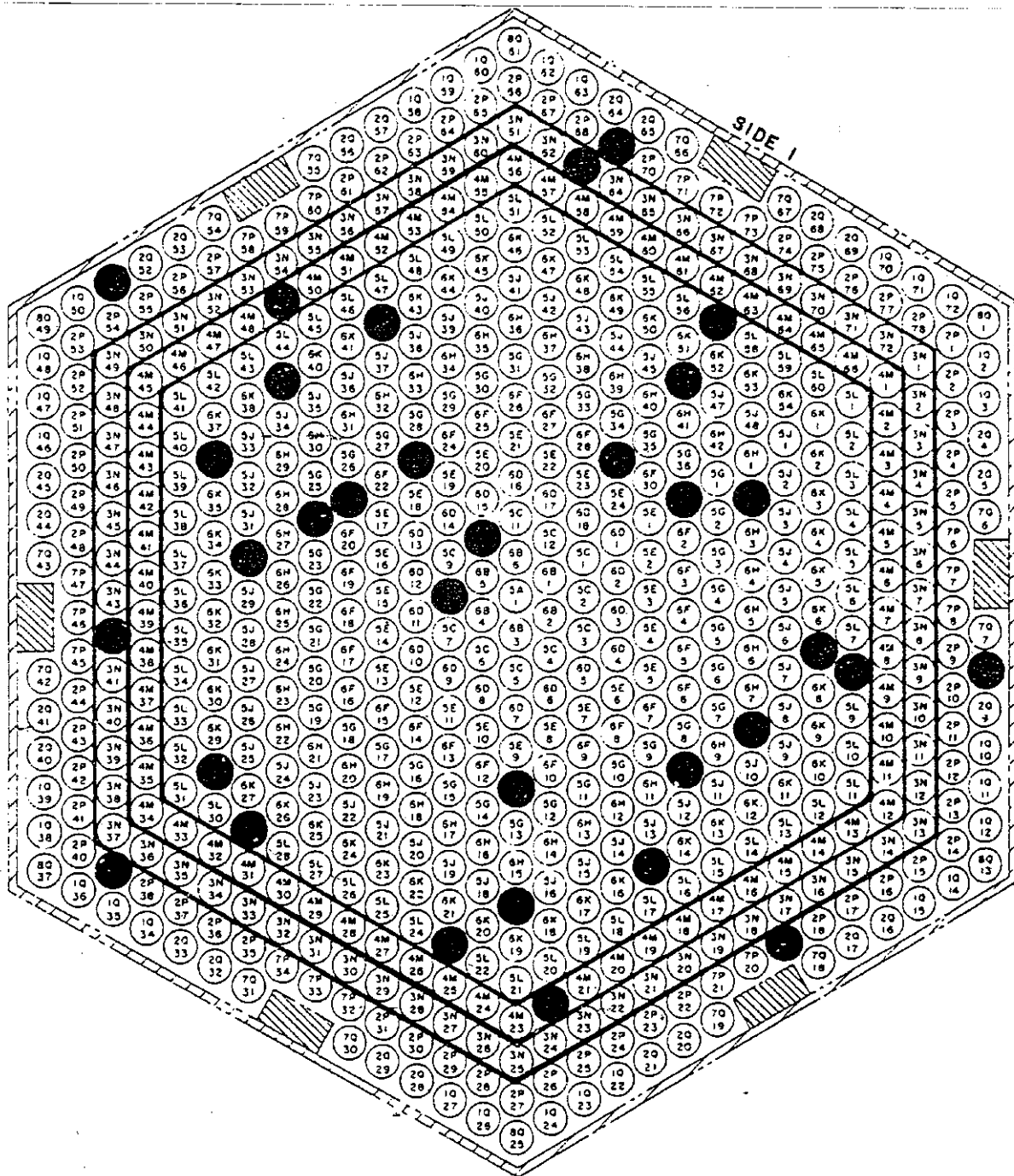

Figure 5-2. Location of proof-of-breeding rods in Seed Module I-1 (Schick et al. 1987, WAPD-TM-1612, Figure V-2).

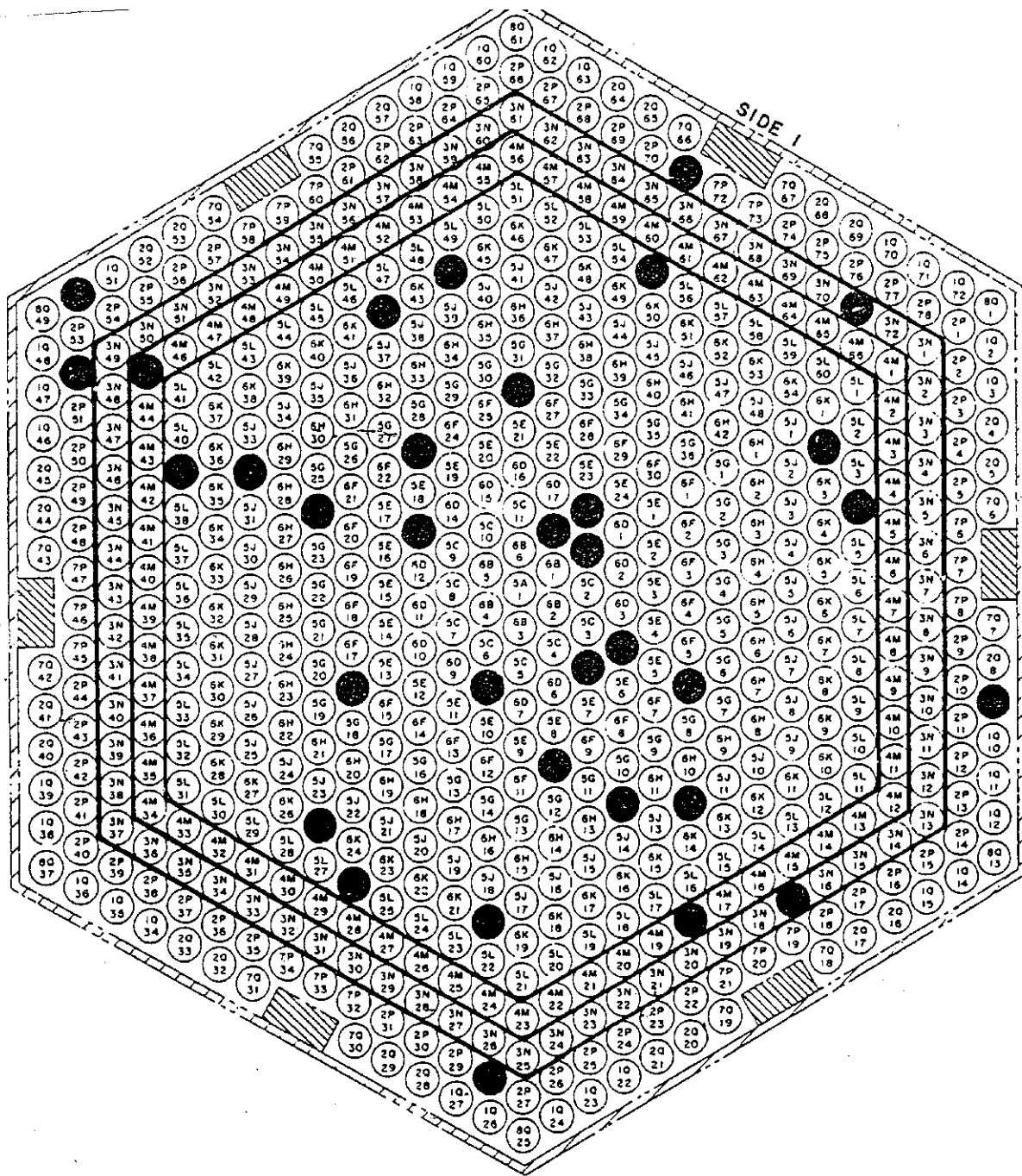

Figure 5-3. Location of proof-of-breeding rods in Seed Module II-3 (Schick et al. 1987, WAPD-TM-1612, Figure V-3).

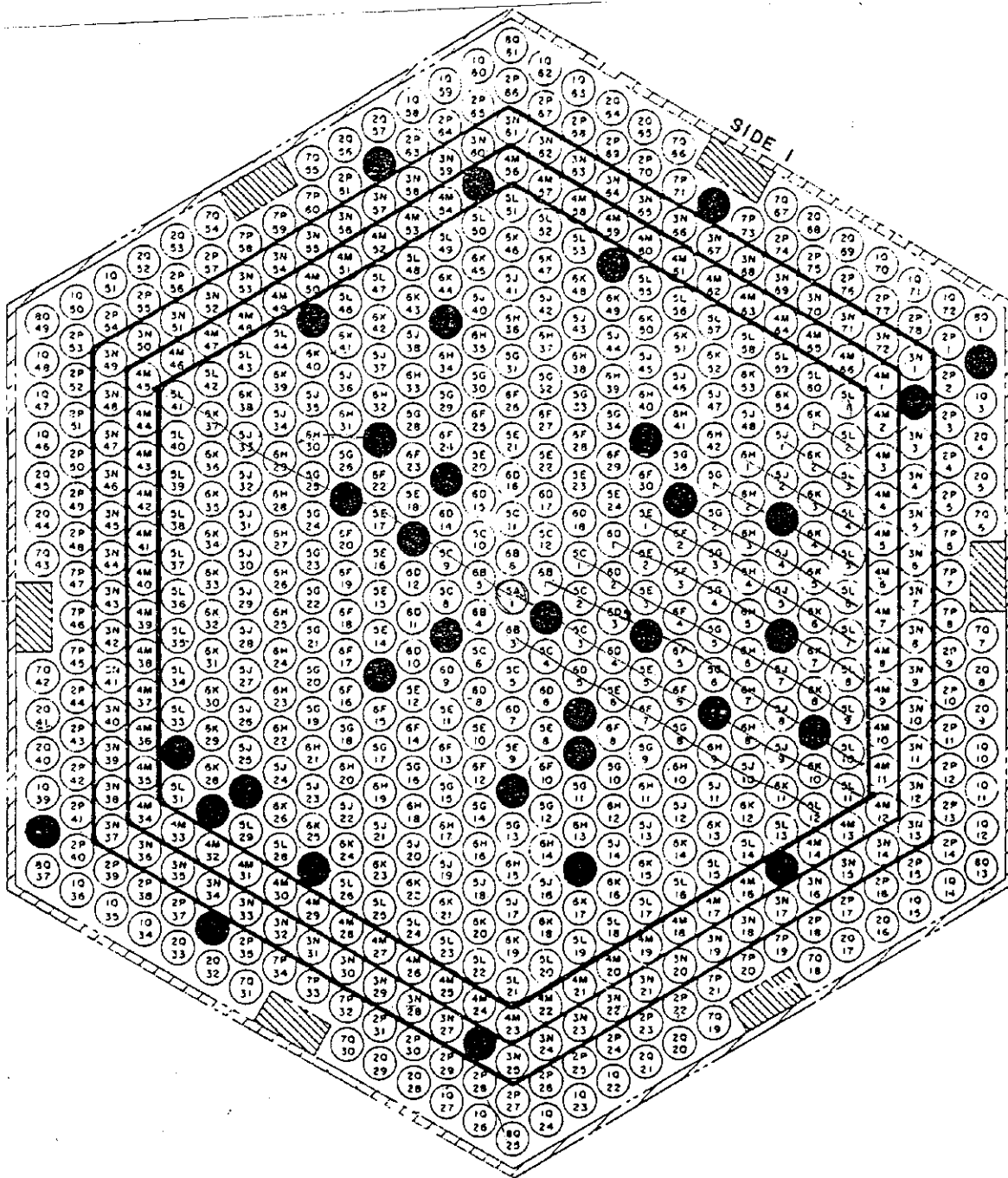

Figure 5-4. Location of proof-of-breeding rods in Seed Module III-1 (Schick et al. 1987, WAPD-TM-1612, Figure V-4).

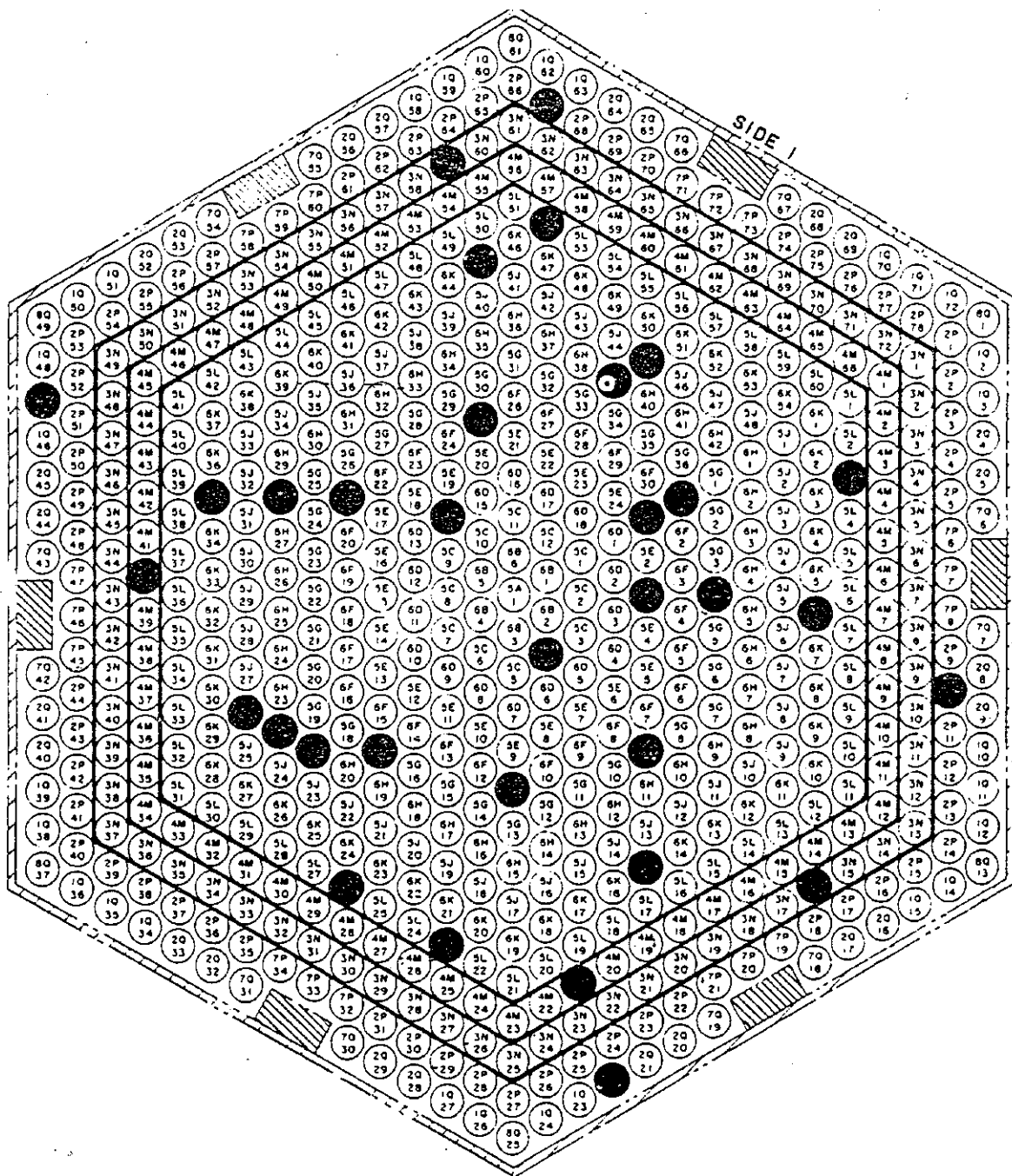

Figure 5-5. Location of proof-of-breeding rods in Seed Module III-2 (Schick et al. 1987, WAPD-TM-1612, Figure V-5).

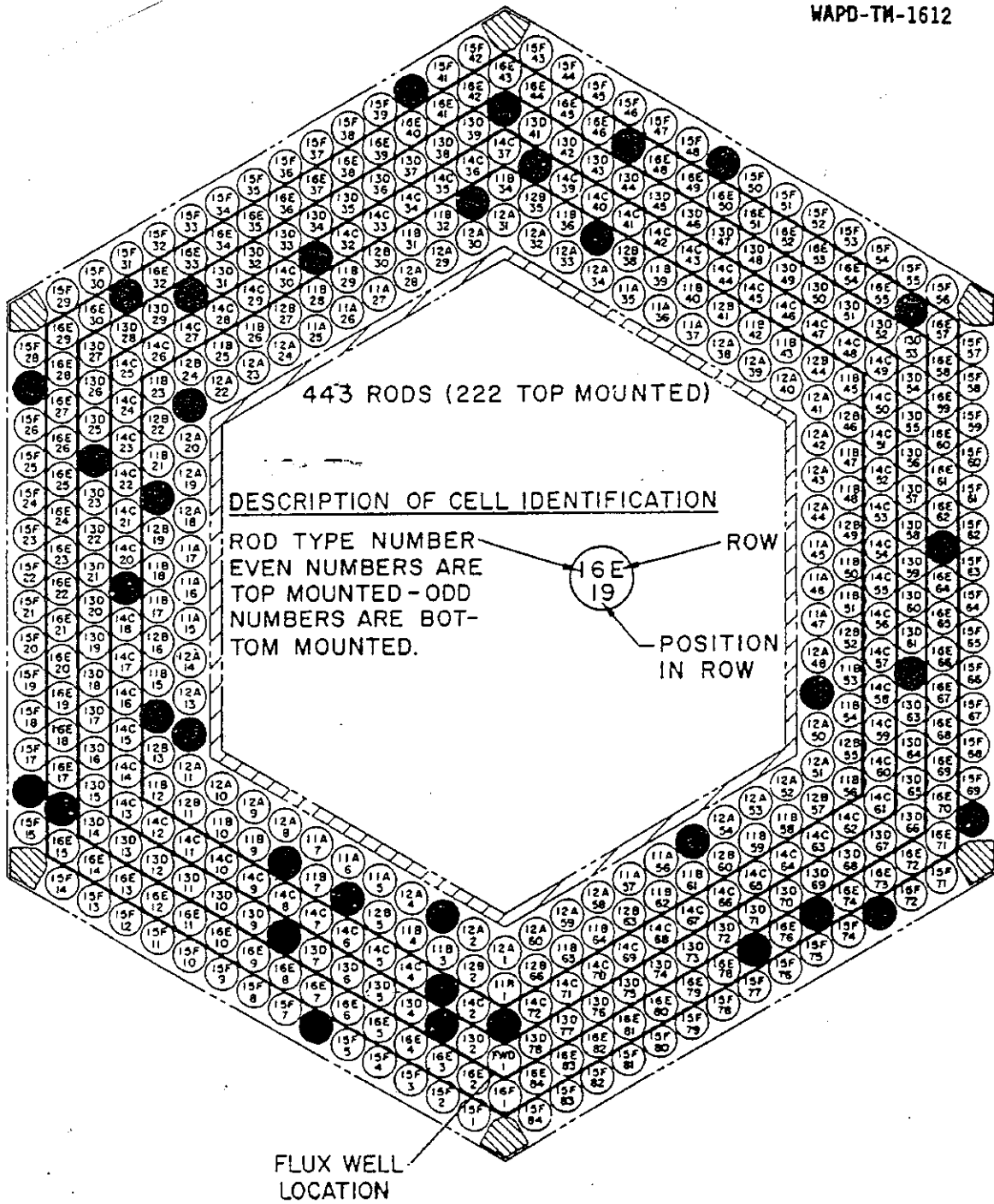

Figure 5-6. Location of proof-of-breeding rods in Blanket Module I-3 (Schick et al. 1987, WAPD-TM-1612, Figure V-6).

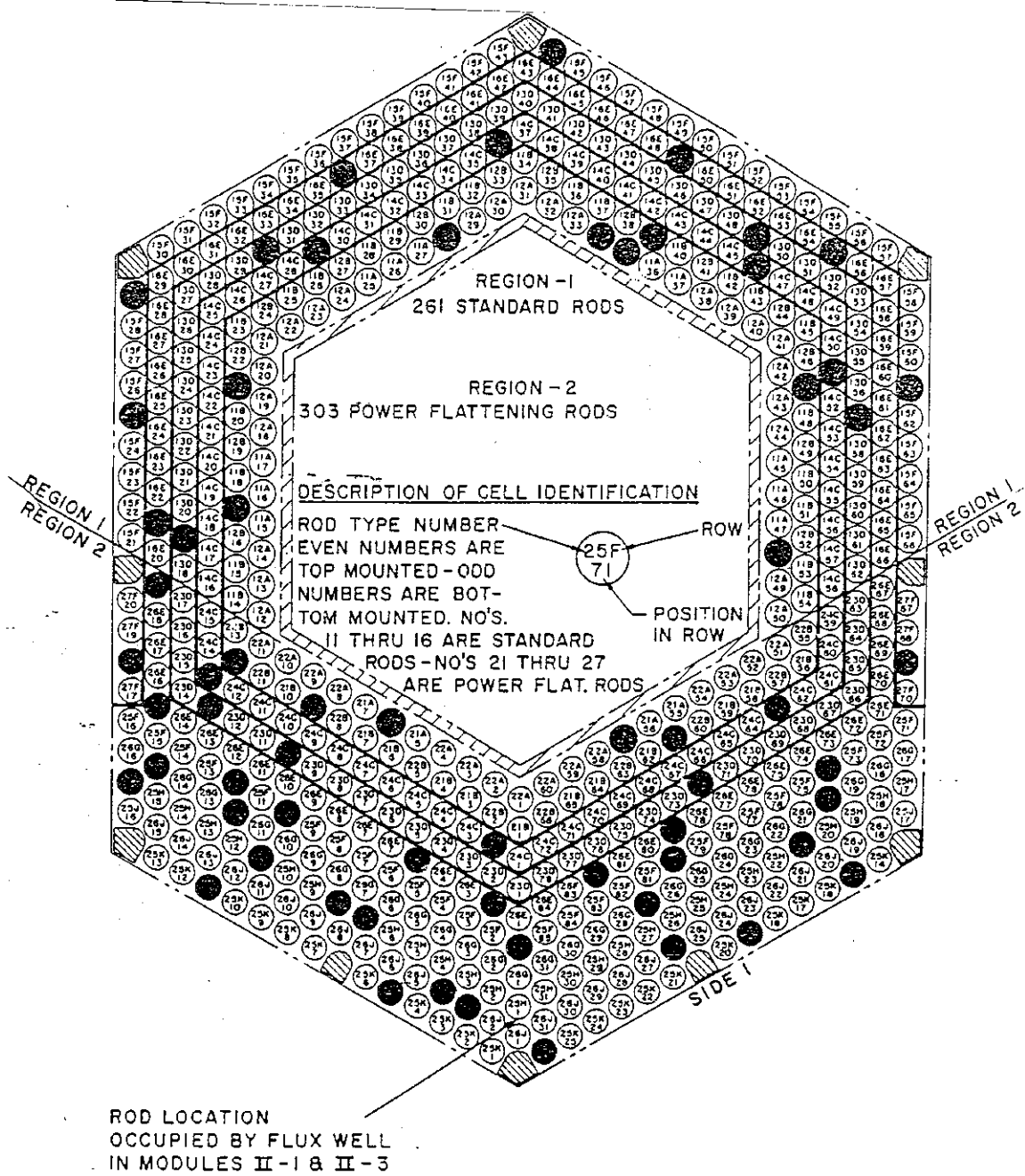

Figure 5-7. Location of proof-of-breeding rods in Blanket Module II-2 (Schick et al. 1987, WAPD-TM-1612, Figure V-7).

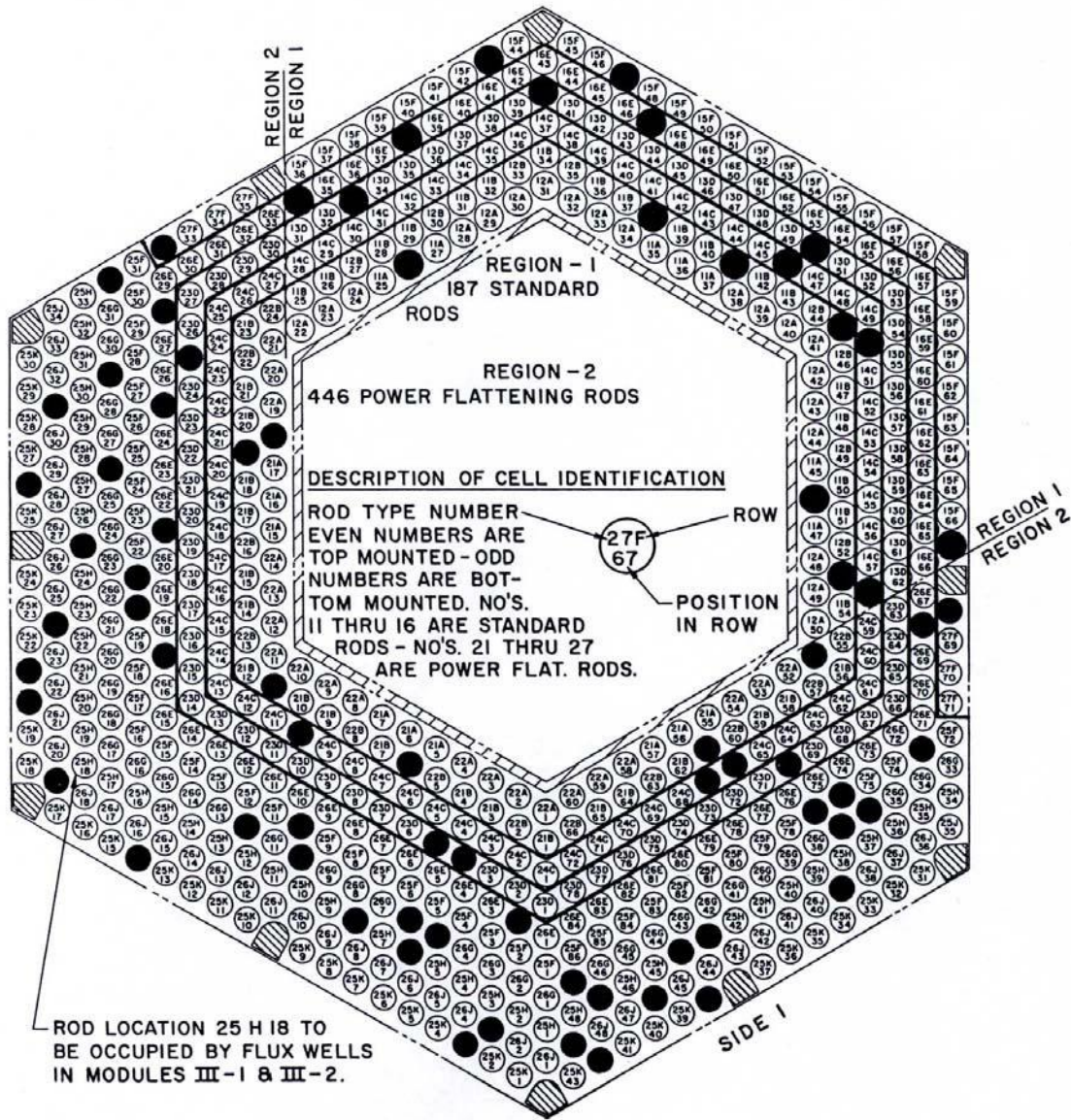

Figure 5-8. Location of proof-of-breeding rods in Blanket Module III-2 (Schick et al. 1987, WAPD-TM-1612, Figure V-8).

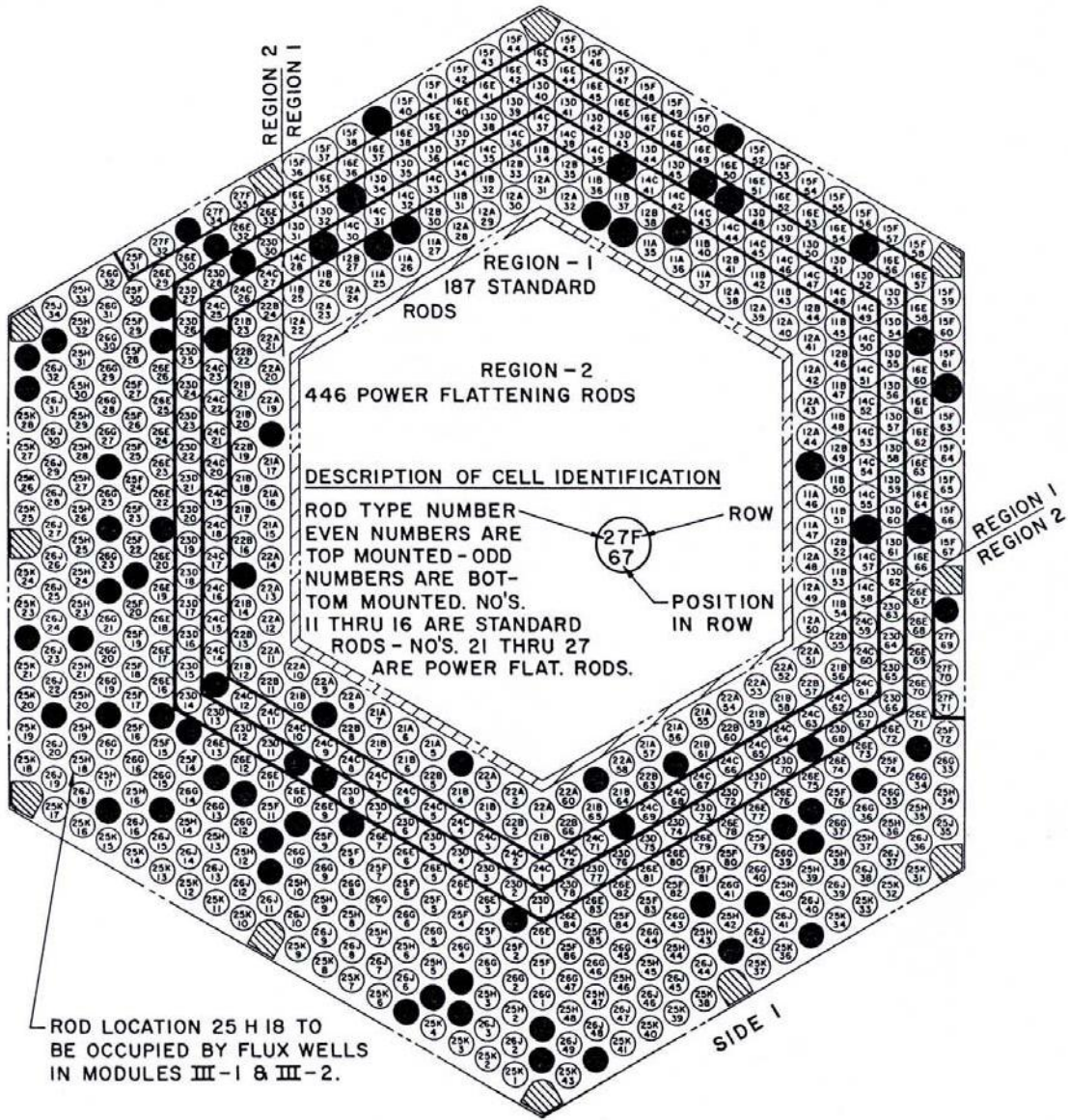
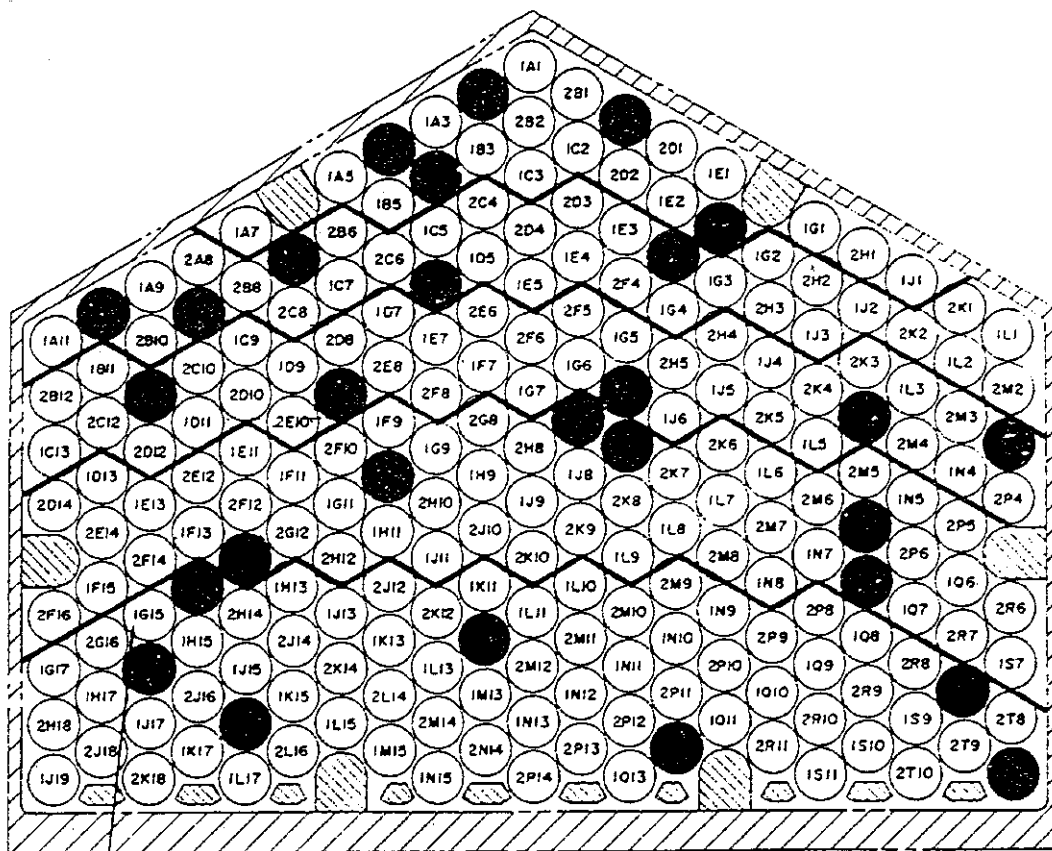

Figure 5-9. Location of proof-of-breeding rods in Blanket Module III-6 (Schick et al. 1987, WAPD-TM-1612, Figure V-9).



ROD LOCATION IG15 TO BE OCCUPIED
BY FLUX WELL IN MODULE IV-7

IDENTIFICATION LEGEND
EXAMPLE:

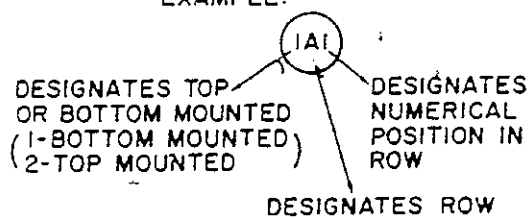
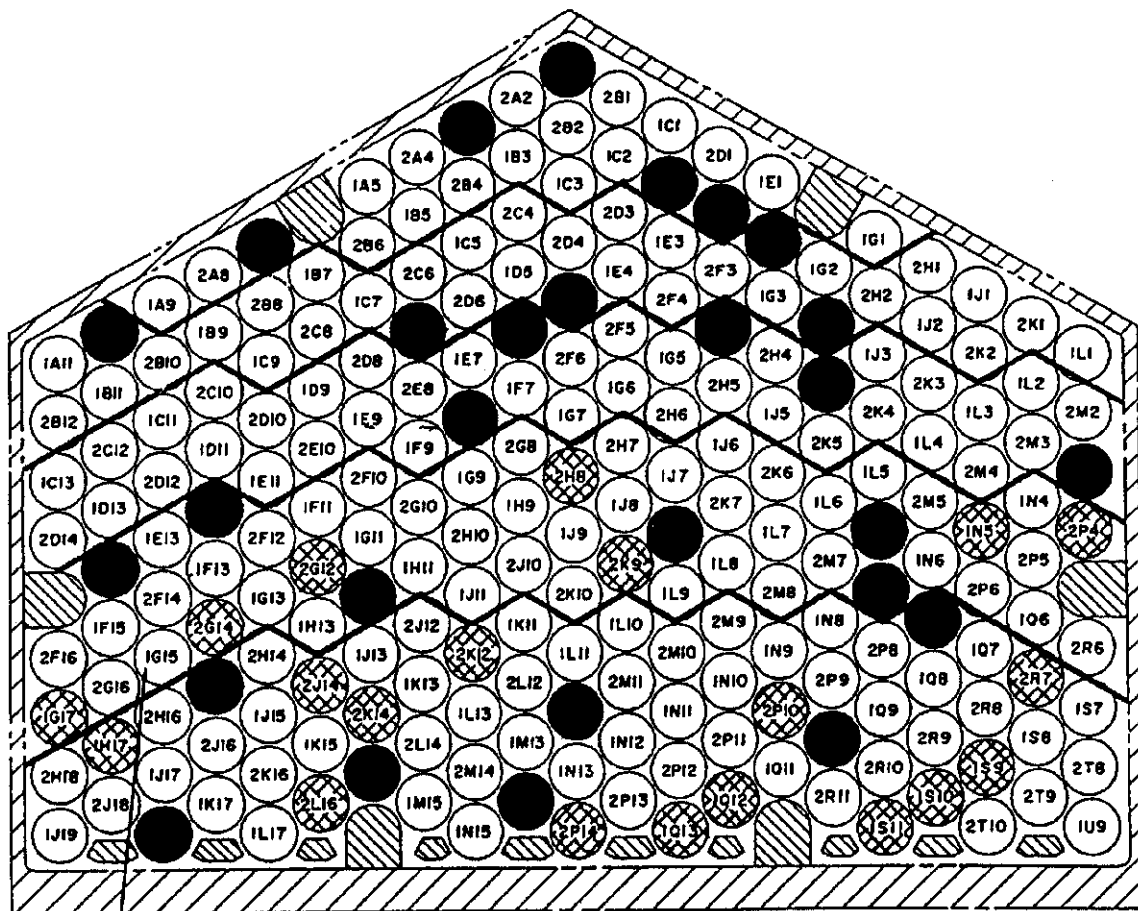

Figure 5-10. Location of proof-of-breeding rods in Reflector Module IV-4 (Schick et al. 1987, WAPD-TM-1612, Figure V-10).



ROD LOCATION 1G15 TO BE OCCUPIED
BY FLUX WELL IN MODULE IV-7

IDENTIFICATION LEGEND
EXAMPLE:

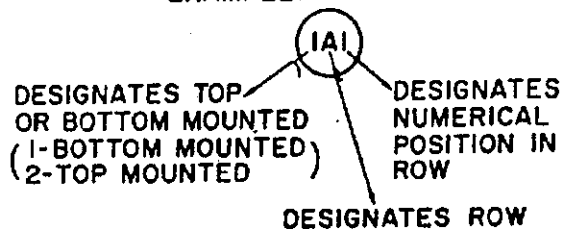
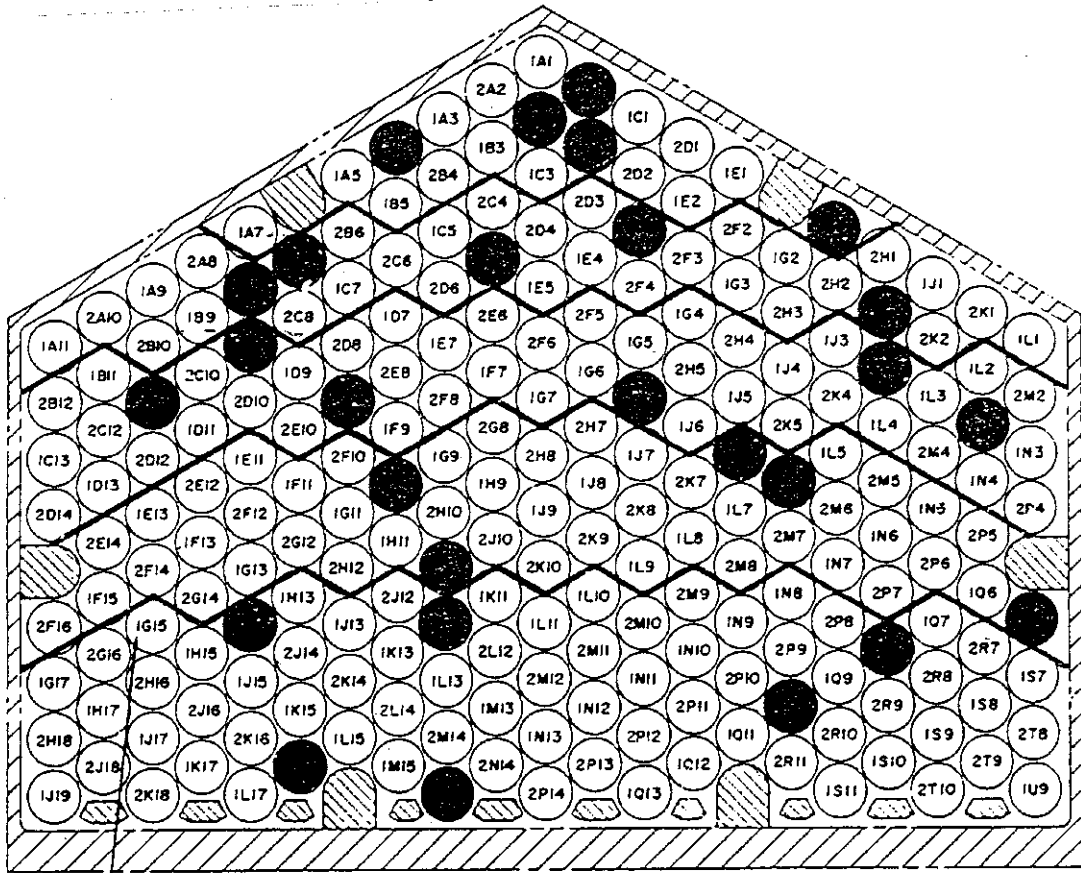

Figure 5-11. Location of proof-of-breeding (POB) rods in Reflector Module IV-9. Twenty additional rods that are not part of the original POB sample are indicated by cross hatching (Schick et al. 1987, WAPD-TM-1612, Figure V-11).



ROD LOCATION 1G15 TO BE OCCUPIED
BY FLUX WELL IN MODULE IV-7

IDENTIFICATION LEGEND
EXAMPLE:

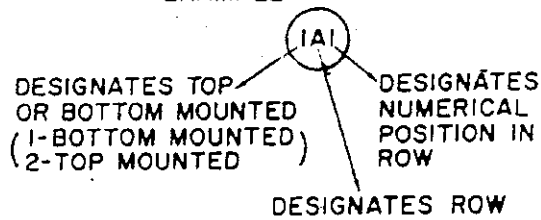
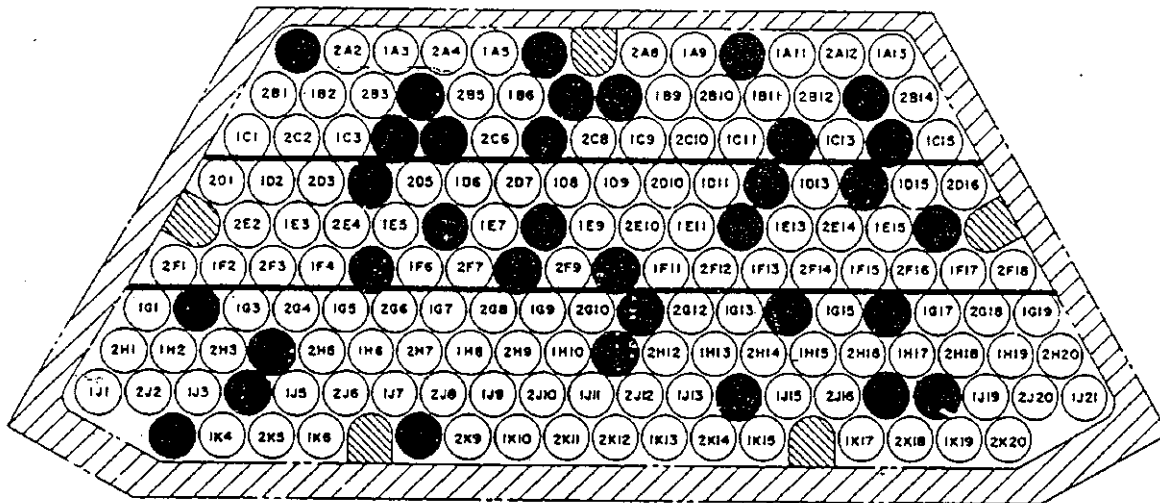

Figure 5-12. Location of proof-of-breeding rods in Reflector Module IV-3 (Schick et al. 1987, WAPD-TM-1612, Figure V-12).



IDENTIFICATION LEGEND
EXAMPLE:

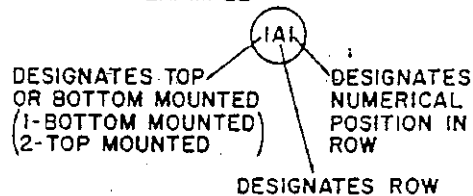

Figure 5-13. Location of proof-of-breeding rods in Reflector Module V-4 (Schick et al. 1987, WAPD-TM-1612, Figure V-13).

sampling plan, and the resulting data were used to estimate the EOL fissile inventory for the whole core. Data from the PIFAG are provided in Appendix A. EOL fissile data from PIFAG were compared with data from extensive destructive evaluations to assess the accuracy of the PIFAG. EOL and beginning-of-life data were compared to determine if breeding had occurred (Tessler et al. 1987, WAPD-TM-1614, p. 1).

The PIFAG used the method of active neutron interrogation and delayed neutron counting (see Tessler et al. 1987, WAPD-TM-1614) to determine the fissile uranium loading of each rod. The PIFAG was assembled in a hot cell at Naval Reactors ECF. As-fabricated (unirradiated) rods were used to calibrate the PIFAG. Isotopic loadings for individual unirradiated seed, standard blanket, power-flattening and reflector rods are presented in Table 5-4. Core rod testing was conducted from June 1984 to May 1987 (Tessler et al. 1987, WAPD-TM-1614).

Rods were irradiated by neutrons from four Cf-252 sources, then delayed neutrons resulting from the fissions occurring from the source were counted as the rod passed through the detector region. The indium-cadmium liner in the PIFAG could be positioned to provide thermal or epithermal neutron interrogation spectrum. After an epithermal mode foreground pass, the rods were gamma scanned, and a cumulative gamma ray spectrum was recorded (Tessler et al. 1987, WAPD-TM-1614, p. 25). The PIFAG performance was closely monitored. The accuracy of the PIFAG was determined by comparing PIFAG results with destructive analysis results for 17 of the rods (Tessler et al. 1987, WAPD-TM-1614, p.74).

Table 5-4. Calibration rod isotopic loadings. All values are in grams (Tessler et al. 1987, WAPD-TM-1614, Table 24).

a. Seed Rods							
Rod ID	²³² U	²³³ U	²³⁴ U	²³⁵ U	²³⁶ U	²³⁸ U	²³² Th
05001	0.0	0.0	0.0	0.0	0.0	0.0	745.5
05004	0.0	0.0	0.0	0.0	0.00	0.0	746.2
05061	2.05E-5	3.401	0.0400	2.92E-3	4.18E-4	0.0351	728.2
05062	2.05E-5	3.402	0.0400	2.92E-3	4.18E-4	0.0352	728.4
05121	4.91E-5	8.131	0.0957	6.99E-3	9.98E-4	0.0840	721.1
05122	4.91E-5	8.132	0.0957	6.99E-3	9.98E-4	0.0840	721.5
05273	1.11E-4	18.308	0.215	0.0157	2.25E-3	0.189	712.1
0100500	9.97E-5	14.196	0.194	0.0176	3.90E-3	0.0448	716.5
0301754	1.55E-4	19.110	0.233	4.47E-3	1.94E-4	0.0697	708.1
0401863	1.67E-4	23.698	0.323	0.0294	6.52E-3	0.0743	698.0
0414466	1.67E-4	24.077	0.321	0.0201	4.65E-3	0.0705	702.6
05431	2.25E-4	28.709	0.350	6.71E-3	2.92E-4	0.104	695.8
05432	2.25E-4	28.709	0.350	6.71E-3	2.92E-4	0.104	695.6
0511165	2.49E-4	34.548	0.431	0.0133	1.75E-3	0.0782	691.9
0527674	2.48E-4	34.797	0.457	0.0269	6.37E-3	0.1005	691.6

b. Regular Blanket Rods							
Rod ID	²³² U	²³³ U	²³⁴ U	²³⁵ U	²³⁶ U	²³⁸ U	²³² Th
15002	0.0	0.0	0.0	0.0	0.0	0.0	2954.3
15004	0.0	0.0	0.0	0.0	0.0	0.0	2959.0
15061	8.35E-5	13.838	0.163	0.0119	1.70E-3	0.143	2949.5
15064	8.35E-5	13.828	0.163	0.0119	1.70E-3	0.143	2949.0
1103425	1.41E-4	16.445	0.221	0.0135	3.51E-3	0.0452	2931.2
1104780	1.40E-4	16.431	0.221	0.0135	3.51E-3	0.0451	2936.2
15122	2.57E-4	32.814	0.475	0.0478	0.0154	0.0823	2910.7
15124	2.58E-4	32.829	0.475	0.0478	0.0154	0.0823	2912.2
1412359	2.54E-4	30.094	0.392	0.0190	3.98E-3	0.0826	2953.6
1501827	3.89E-4	45.577	0.612	0.0380	9.74E-3	0.124	2915.2
1512019	3.89E-4	45.528	0.611	0.0380	9.73E-3	0.124	2914.9
1300545	3.83E-4	45.399	0.604	0.0362	9.15E-3	0.119	2904.0
1613659	4.59E-4	54.397	0.719	0.0431	0.0111	0.143	2923.6
1613834	4.59E-4	54.380	0.719	0.0431	0.0111	0.143	2922.3

c. Power Flattening Blanket Rods							
Rod ID	²³² U	²³³ U	²³⁴ U	²³⁵ U	²³⁶ U	²³⁸ U	²³² Th
25001	0.0	0.0	0.0	0.0	0.0	0.0	2488.9
25004	0.0	0.0	0.0	0.0	0.0	0.0	2493.2
25063	7.04E-5	11.660	0.137	0.0100	1.43E-3	0.120	2489.8
25064	7.03E-5	11.646	0.137	0.0100	1.43E-3	0.120	2486.5
25122	1.69E-4	27.930	0.329	0.0240	3.43E-3	0.289	2473.8
25123	1.69E-4	27.940	0.329	0.0240	3.43E-3	0.289	2474.7
2100153	1.60E-4	18.910	0.250	0.0144	3.46E-3	0.0496	2477.8
2103140	1.58E-4	18.972	0.257	0.0180	4.83E-3	0.0521	2471.2
25161	3.19E-4	37.813	0.500	0.0292	6.92E-3	0.0984	2459.3
25163	3.22E-4	38.168	0.505	0.0295	6.99E-3	0.0993	2459.2
2402626	2.43E-4	30.601	0.424	0.0343	9.97E-3	0.0826	2472.6
2700468	3.82E-4	46.313	0.636	0.0519	0.0146	0.126	2452.6
2701624	3.56E-4	46.523	0.683	0.0749	0.0237	0.124	2455.7
2303222	3.76E-4	52.579	0.639	0.0440	8.59E-3	0.415	2433.6
2500452	4.43E-4	62.959	0.732	0.0398	7.71E-3	0.482	2427.1
2502616	4.51E-4	63.139	0.747	0.0464	0.0122	0.439	2431.0

d. Reflector Rods							
Rod ID	²³² U	²³³ U	²³⁴ U	²³⁵ U	²³⁶ U	²³⁸ U	²³² Th
3106718	0.0	0.0	0.0	0.0	0.0	0.0	6089.4
3108707	0.0	0.0	0.0	0.0	0.0	0.0	6028.1
3102143	0.0	0.0	0.0	0.0	0.0	0.0	6036.7
31062	1.75E-4	29.048	0.342	0.0250	3.57E-3	0.300	6033.9
31063	1.75E-4	29.052	0.342	0.0250	3.57E-3	0.300	6037.6
31123	4.19E-4	69.363	0.816	0.0596	8.52E-3	0.717	5978.9
31124	4.19E-4	69.401	0.817	0.0596	8.52E-3	0.717	5976.9

* Notation n.nnE-n ≡ n.nn × 10⁻ⁿ

Paired t-test analysis of the differences in results by rod type indicates a small statistically insignificant bias at the 5% significance levels (Tessler et al., WAPD-TM-1614, pp. 60–61). Table 5-1 shows the comparative results of the PIFAG and the destructively evaluated rods.

REX. The Rod Examination (REX) gauge measured fuel rod length, diameter, oxide thickness, ovality, wear mark depth, and volume and provided a 5X visual examination and video recording capabilities. The gauge also had the capability of ultrasonic screening of the fuel rod cladding for defects.

Nineteen rods were removed for nondestructive examinations in the REX gauge (12 of those were also destructively examined at ANL-W). The 19 were selected to evaluate the effects of a broad range of parameters on fuel rod performance and included: 6 seed rods, 7 standard blanket rods, 3 power-flattening rods, and 3 reflector rods. Their approximate locations are shown in Figure 5-14.

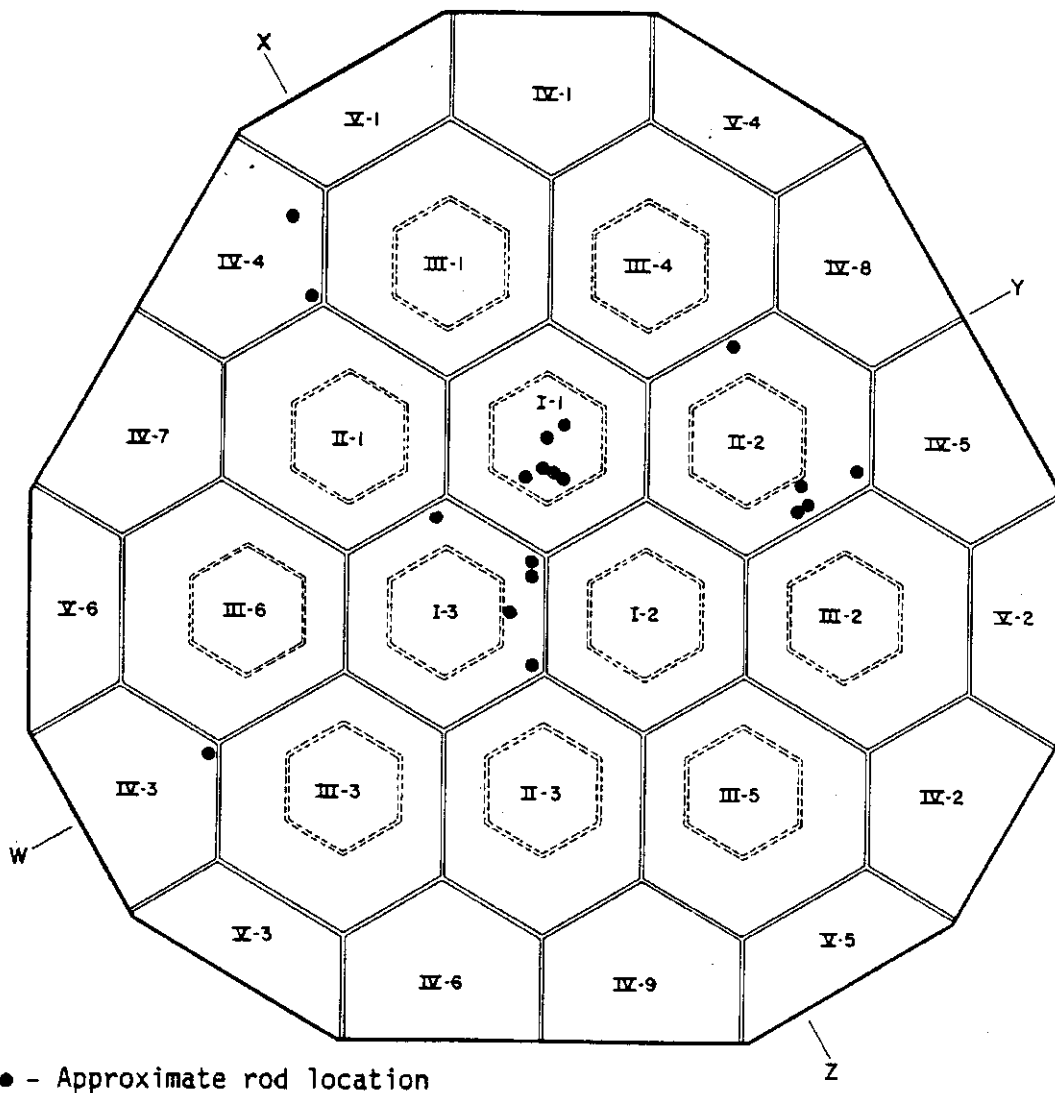

Figure 5-14. Rod examination (REX) fuel rod locations (Gorscak, Campbell, and Clayton 1987, WAPD-TM-1605, Figure 9).

5.1.2 Destructive Examination

Twelve of the 19 rods examined using the REX gauge were shipped to ANL-W for nondestructive neutron radiography, then were punctured to obtain fission gases. Seventeen of the 524 rods examined for fissile content with the PIFAG were shipped to ANL-E for destructive examination for the isotopic content. Destructive examinations conducted on both the 12 rods and the 17 rods are summarized in Table 5-5 and discussed briefly below.

5.1.2.1 Fission Gas Release at End-of-Life. Twenty-nine rods were selected for fission gas (xenon and krypton) analysis, 12 were sent to ANL-W and 17 to ANL-E. Rods were chosen to represent a broad range of as-built and core operating characteristics and to cover a broad range of power density, fuel burnup, and rod neutron fluence. Operating characteristics of the 12 rods selected for analysis by ANL-W are presented in Table 5-6.

Only fission gas released from the plenum was measured at ANL-W. In contrast, ANL-E measured fission gas from the plenum as well as fission gas released during rod shearing and rod dissolution. The method for fission gas sampling of the plenum involved puncturing the rod cladding with a laser, collecting the released gases in a sample collection tube, and analyzing by mass spectrometry for xenon and krypton (Richardson et al. 1987, WAPD-TM-1606, pp. 39–40). Results from the plenum tap from both sets of samples are presented in Table 5-7. Results from the plenum puncture, shearing, and dissolution samples for the 16 rods are presented in Table 5-8.

Plenum gas analyses were only obtained for 11 of the 12 sampled rods at ANL-W (the twelfth sample was lost during plenum tap) and from 16 of the 17 rods from ANL-E (one sample was contaminated with nitrogen and oxygen from the room). Results from the 11 ANL-W samples and all 17 ANL-E samples are presented in Table 5-7.^b Core locations of the 28 rods can be determined using the cell numbers presented in Table 5-7 along with the cell maps presented in Section 3. All rods were shown to have gas release levels below the low-temperature prediction line. Because fuel rods from peak temperature and peak depletion locations were included in the samples, all fuel was considered to have operated at temperatures below 2580°F (Richardson et al. 1987, WAPD-TM-1606, pp. 49–50).

5.1.2.2 Isotopic Results. The 17 rods shipped to ANL-E were analyzed for isotopic inventory. Total uranium and uranium isotopic (U-233, U-234, U-235, U-236, U-238) analyses were performed by thermal ionization mass spectrometry. Because of the interference of Th-232, U-232 was determined by alpha spectrometry (ANL-E data reports). Fission products Cs-137, Ce-144, and Nb-95 (Zr-95 daughter) were determined by gamma spectrometry (high purity germanium detector with associated automated multi-channel analyzer/data management system) on weighed aliquots of the samples. Cs-137 and Ce-144 were determined on a sample aliquot by direct counting. Zirconium-95 was obtained after processing the sample aliquot through a cleanup procedure to reduce interferences. The losses of Zr-95 were accounted for by using before and after values of the Ce-144. Error requirements for Zr-95 measurements that were made after October 1984 were waived due to the short half-life (64.02 days).

Results from isotopic analyses were sent to Lockheed Martin Idaho Technologies Company by the former project manager (Don Graczyk, Analytical Chemistry Laboratory, Chemical Technology Division, ANL-E) of the destructive evaluation at ANL-E. These results are summarized in Table 5-9 and provided in detail in Appendix B.

b. According to the notes attached to the sample report for the contaminated sample (Rod “R” as referred to in Appendix B), ANL-E provided Bettis with sufficient data to calculate or compile fission data for Rod “R.”

Table 5-5. Destructive examinations (Richardson et al. 1987, WAPD-TM-1606).

Test	Purpose	Number of Samples	Results	Testing Facility
Fission gas release (mass spectrometry)	Quantify fission gases, which are an indication of fuel temperatures achieved during reactor operation.	12 rods by Argonne National Laboratory-West (ANL-W) 17 rods by Argonne National Laboratory-East (ANL-E)	Estimated operating temperature of all the fuel was less than 2580°F (Richardson et al. 1987, WAPD-TM-1606, p. 49–50). Fission gas in the gap (plenum) comprises less than 1% of total fission gases measured from the rods (ANL-E data).	ANL-W ANL-E
Metallographic examination	Size and spatial distribution of pores, cracks, grain size, internal and external corrosion, fuel and cladding mechanical and chemical interaction, hydriding, hydrogen in cladding.	12 rods (or pellets from the rods) selected by Bettis	Low burnup thorium pellets were intact. Binary pellets often cracked but freestanding within the cladding. Fine porosity. No evidence of fuel bonding to zircaloy cladding in seed, but some in blanket region rods. No massive hydriding. (Richardson et al. 1987, WAPD-TM-1606, pp.50–123)	ANL-E
Cladding behavior	Detect cladding inadequacies.	Cladding of 12 rods checked	No through-cladding defects detected (Richardson et al. 1987, WAPD-TM-1606, p. 80)	Expended Core Facility (ECF)
Cladding oxide	Identify thickness of oxide layer on the cladding	12	Thickness of the oxide ranged from .05 to 1.95 mils (Table 10 of Richardson et al. 1987, WAPD-TM-1606)	ECF
Hydrogen analysis of the cladding	Assess hydriding of the cladding	12	Hydride size and distribution varied by rod type. Total H content: Seed: 50 to 100 ppm Blanket: 25 to 100 ppm Reflector: 25 to 50 ppm (Richardson et al. 1987, WAPD-TM-1606, pp. 87–88)	ECF

Table 5-5. (continued).

Test	Purpose	Number of Samples	Results	Testing Facility
Fuel depletion (fissions per cc of fuel). Isotopic dilution mass spec of HNO ₃ -HF dissolved samples for total Th and U, isotopic U, and La-139 and Nd-148. La-139 and Nd-148 were burnup monitors (Richardson et al. 1987, WAPD-TM-1606, p. 124). Gamma spec for Cs-137 and Ce-144	Compare destructive examination to calculated burnup and qualify the calculational model (Richardson et al. 1987, WAPD-TM-1606, p. 44).	2 of the 12 destructive examination rods were analyzed for fuel burnup (from a seed and standard blanket). For each rod, one sample pellet was taken from top thorium region and second sample from adjacent top binary pellet.	Measured depletion and burnup values were consistently lower (about 10% or less) than calculated values for both rods (Richardson et al. 1987, WAPD-TM-1606 Table 15). Calculated values based on a 3.5-in. rod segment vs. measured values based on pellet analysis.	ANL-E
Iodine and cesium analysis of fuel and cladding	Iodine and cesium are possibly corrosive agents causing stress corrosion cracking. Tests to determine the fraction of these nuclides that migrate to the gap region and into the cladding.	2 sample locations per 2 seed rods 2 sample locations in 2 standard blanket rods	Minute quantities of I-129 in rod or pellet. Iodine confirmed to be in fuel, none in cladding. Cesium primarily dissolved in the fuel and small quantities in cladding (Richardson et al. 1987, WAPD-TM-1606, Tables 16 and 17).	ANL-E
Tensile testing of cladding	Assess strength of cladding after service.	At 77°F: 2 seed 1 standard blanket 1 reflector At 500°F: 2 seed 1 reflector	Mechanical properties of Light Water Breeder Reactor fuel adequate throughout core life (Richardson et al. 1987, WAPD-TM-1606 Table 18 and Figure 71)	ANL-E

Table 5-6. Operating characteristics of the 12 Light Water Breeder Reactor destructive examination fuel rods at end-of-life (Richardson et al. 1987, WAPD-TM-1606, Table 6).

Module Type	Rod S/N	Peak Power (Kw/ft)	Peak Depletion (10^{20} f/cc)	Peak Burnup MWD/MTM*	Peak Fast Fluence (>1 Mev) (10^{20} n/cm ²)
Seed I-1	0400736	6.7	9.52	44,500	85.0
Seed I-1	0606773	4.4	8.81	41,200	96.5
Seed I-1	0205071	5.5	11.43	53,400	75.5
Seed I-1	0507672	4.2	10.12	47,300	87.9
Blanket I-3	1606710	8.7	5.07	22,300	73.0
Blanket I-3	1105717	8.6	5.18	22,800	71.4
Blanket I-3	1504272	7.4	4.37	19,200	64.2
Blanket II-2	1208823	6.9	4.25	18,700	55.4
Blanket II-2	2610746	8.7	5.70	25,200	57.7
Blanket II-2	2514164	8.3	5.05	22,300	38.6
Blanket II-2	2607600	8.4	5.53	24,400	58.6
Reflector IV-3	3102657	3.4	0.96	4,100	25.9

* MWD/MTM = Megawatt days per metric ton of metal (uranium plus thorium)

Table 5-7. Light Water Breeder Reactor fuel rod fission gas release at end-of-life (Richardson et al. 1987, WAPD-TM-1606, Table 7).

Rod S/N	Cell	Module	Rod-average Depletion (10 ²⁰ f/cc)	Generated in Fuel* (mol)	Fission Gas		
					Measured in Plenum Tap (10 ⁻⁵ mol)	Recovered Fraction**	Released (%)***
0606773	6B4	SI-1	5.4	0.02683	1.22	0.803	0.06
0507672	5L31	SI-1	6.4	0.03198	2.51	0.725	0.11
0504042	5L29	SI-1	6.0	0.03007	2.37	0.734	0.11
0507057	5C10	SI-1	5.1	0.02575	1.30	0.744	0.07
0400736	4M33	SI-1	5.3	0.02631	1.51	0.912	0.06
0401744	4M49	SI-1	4.8	0.02398	3.76	0.849	0.18
0307602	3N63	SI-1	4.2	0.02120	1.36	0.767	0.08
0205071	2Q41	SI-1	4.5	0.02266	1.02	0.782	0.06
0201562	2P39	SI-1	3.8	0.01890	1.06	0.816	0.07
1606710	16E57	BI-3	2.9	0.05723	3.10	0.662	0.08
1605519	16E56	BI-3	2.9	0.05693	2.76	0.659	0.07
1504272	15F11	BI-3	2.5	0.04831	1.90	0.726	0.05
1400544	14C3	BI-3	1.9	0.03791	1.77	0.959	0.05
1302864	13D24	BI-3	2.4	0.04582	1.49	0.675	0.05
1200830	12A49	BI-3	2.1	0.04051	1.37	0.695	0.05
1208823	12A12	BII-2	1.8	0.03436	0.89	0.788	0.03
1105717	11A46	BI-3	2.2	0.04304	2.27	0.722	0.07
2610746	26E68	BII-2	3.3	0.05531	3.22	0.646	0.09
2606481	26E31	BIII-6	3.1	0.05424	3.43	0.743	0.09
2514164	25K13	BII-2	2.9	0.04741	1.63	0.629	0.06
2513854	25F73	BIII-6	2.6	0.04345	1.46	0.655	0.05
2502102	25H1	BIII-6	1.3	0.02209	0.22	0.770	0.01
2400408	24C13	BIII-6	1.4	0.02319	0.38	0.725	0.02
2300711	23D29	BIII-6	2.8	0.04622	2.54	0.633	0.09
2102187	21B62	BIII-6	1.5	0.02380	0.44	0.729	0.03
3102657	1A1	RIV-3	0.5	0.01856	0.17	0.983	0.01
3211456	2B1	RIV-3	0.4	0.01659	0.12	0.788	0.01
3110505	1E3	RIV-3	0.2	0.00687	0.04	0.999	0.01

- * Calculated from rod-average depletion
 ** Ratio of helium recovered to calculated amount present from initial fill and (n,γ) reaction
 *** Gas release = (Amount measured in plenum tap)/(Amount generated)/(Recovered fraction)

Table 5-8. Fission gases (Kr + Xe) released during processing of Light Water Breeder Reactor rods.
 (Source: Data packages from ANL-E).

Rod ID	Gas released in Plenum Puncture (g)	Gas Released in Shearing (g)	Gas Released in Dissolution (g)	Total Gas Released (g)	Percent Plenum Gas in Total
2606481	0.0037	0.0140	5.3379	5.3556	0.0691
2513854	0.0017	0.0138	4.9268	4.9423	0.0344
2502102	0.0003	0.0065	2.3256	2.3324	0.0129
2102187	0.0005	0.0065	2.8505	2.8575	0.0175
2400408	0.0005	0.0044	2.5041	2.5091	0.0199
2300711	0.0030	0.0192	4.9428	4.9650	0.0604
3211456	0.0001	0.0032	1.8676	1.8709	0.0053
1605519	0.0033	0.0151	6.6098	6.6283	0.0498
1200830	0.0016	0.0158	5.0025	5.0198	0.0319
1302864	0.0018	0.0091	5.3405	5.3514	0.0336
1400544	0.0022	0.0078	4.2974	4.3074	0.0511
0504042	0.0029	0.0183	3.6756	3.6968	0.0784
0507057	0.0016	0.0131	3.0711	3.0859	0.0518
0201562	0.0013	0.0161	2.4877	2.5051	0.0519
0307602	0.0012	0.0134	2.7539	2.7685	0.0433
0401744	0.0046	0.0181	3.0852	3.1079	0.1480

Table 5-9. Isotopic results from Argonne National Laboratory-East destructive examination of 17 Light Water Breeder Reactor rods.

Module and Cell Location	Length (in.)	U-232 (g)	U-233 (g)	U-234 (g)	U-235 (g)	U-236 (g)	U-238 (g)	Cs-137 (g)	Ce-144 (g)	Zr-95 (g)
PFB III-6 E31	118.19	0.048833	50.697	4.9377	0.77915	0.086475	0.15378	1.3314	0.068311	0.00029782
PFB III-6 F73	118.17	0.038269	53.065	4.2727	0.61827	0.069008	0.15432	1.0884	0.05748	0.00025527
PFB III-6 H1	118.07	0.011363	57.097	2.5111	0.22817	0.014398	0.45712	0.55456	0.030255	0.00014121
PFB III-6 B62	118.1	0.035986	28.912	2.2675	0.31601	0.025272	0.047159	0.62564	0.039853	0.00019086
PFB III-6 C13	118.14	0.02448	33.612	2.2119	0.28089	0.022936	0.077994	0.56341	0.033364	0.0001649
PFB III-6 D29	118.16	0.047229	44.4489	4.4039	0.71007	0.075831	0.12314	1.2045	0.062935	0.00029186
R IV-3 B1	111.17	0.03567	34.63	1.4876	0.1396	0.00497	0.002403	0.40327	0.031655	0.00016271
SB I-3 E56	118.17	0.072399	51.405	5.2338	0.88411	0.075202	0.11883	1.444	0.074399	0.00033378
SB I-3 A49	118.21	0.075275	35.902	3.8718	0.69573	0.065544	0.036364	1.124	0.070642	0.00034347
SB I-3 D24	118.16	0.060678	46.432	4.3487	0.73112	0.069634	0.09946	1.169	0.06352	0.0002886
SB I-3 C3	118.15	0.061431	40.025	3.5948	0.5826	0.044207	0.072962	0.98522	0.057713	0.00028351
S I-1 5L29	116.98	0.023971	22.331	2.7358	0.46199	0.040206	0.082102	0.78023	0.037911	0.00017893
S I-1 5C10	116.97	0.022944	25.151	2.5057	0.40467	0.030226	0.082867	0.66492	0.034177	0.00016321
S I-1 2P39	116.86	0.022106	13.568	1.689	0.29413	0.027545	0.044155	0.49799	0.031122	0.00017505
S I-1 3N63	117	0.021506	15.303	1.881	0.33739	0.035724	0.050802	0.54545	0.031287	0.00015271
S I-1 4M49	116.94	0.023016	17.058	2.124	0.37119	0.032009	0.072576	0.61732	0.032358	0.00016065
RIV-3 E3	111.21	0.014029	23.68	0.6758	0.044932	0.001001	0.001645	0.17928	0.014956	0.000087136

Data from the nondestructive (PIFAG) and destructive (ANL-E dissolution) examinations for fuel loading were compared to assess the accuracy of the PIFAG and to demonstrate breeding; results showed the Fissile Inventory Ratio (ratio of the fissile inventory at EOL versus beginning-of-life) was 1.01, which included fissile inventory gains in the reflector rods.

5.1.2.3 Isotopic and Heat Rate Validation Studies. Recent validation work has been performed in support of radionuclide inventory and heat rate predictions for the LWBR modules. One study (Sterbentz 1999) focused on the prediction of uranium, fission product, krypton, and xenon isotopic masses in a seed, a blanket and a reflector rod. A comparison of the results showed less than a 5% difference between the calculated and measured mass concentrations in the three rods for the two major uranium isotopes (U-233, U-234). Further discussion on the comparisons for the other isotopes is given in the reference.

Heat rate predictions (Sterbentz and Wahnschaffe 2001) were calculated for a single seed (Type I), standard blanket (Type I), standard/power-flattening blanket (Type II), standard/power-flattening blanket (Type III), Reflector IV, and Reflector V module. Module heat rates are given as a function of decay date (2000-2030). These calculated module heat rates were also compared to heat rates reported in WAPD-NRF(L)C-104, which were calculated values verified against actual LWBR module decay heat measurements. The Sterbentz and Wahnschaffe (2001) calculated values were 33% and 29% higher than the WAPD-NRF(L)C-104 values for a single seed module and a single standard blanket/power-flattening blanket module, respectively. The Sterbentz and Wahnschaffe (2001) Reflector IV decay heat value was about 29% lower than the WAPD value.

5.2 Fuel Burnup

Fuel burnup is defined in terms of fissions per cubic centimeter of fuel, or more often, given in terms of megawatt days per metric ton of initial heavy metal (Richardson et al. 1987, WAPD-TM-1606, p. 44). In the case of LWBR, the initial heavy metal includes both uranium and thorium. Calculated burnup data are provided in several places in Richardson 1987 (WAPD-TM-1606, p. 37) for the 12 rod samples that were destructively examined at ECF.

Only 2 of the 12 rods destructively evaluated by ANL-W were selected for burnup evaluation and model verification; those two rods were seed rod 0205071 and standard blanket rod 1606710 (Richardson et al. 1987, WAPD-TM-1606, p. 44). Two fuel pellets from each of the two rods were analyzed and compared with calculated burnup values to qualify the calculational model. For each of the two fuel rods examined for burnup, one of the pellets was taken from the top thoria region, and the second pellet was taken from the adjacent top binary pellet.

Pellets were removed from the cladding and dissolved in acid solution (HNO₃-HF) without comminution (pulverization). After decontamination of the analytes from interferences and radioactive fission products, total thorium and uranium, isotopic uranium, and stable fission products La-139 and Nd-148 were measured by isotopic dilution mass spectroscopy. (Note from Richardson et al. 1987, WAPD-TM-1606, p. 124: La-139 and Nd-148 were burnup monitors.) The mass spectrometer was calibrated with isotopically pure ThO₂ and a National Institute of Standards and Technology uranium standard.

Calculated and measured burnup data for the two seed pellets (Rod No. 0205071 from location Q41) and the two blanket pellets (Rod No. 1606710 from location E57) are presented in Table 5-10. Calculated burnups for a larger variety of rods are presented in Table 5-6.

Table 5-10. Comparison of measured and calculated fuel depletion and burnup (Richardson et al. 1987, WAPD-TM-1606, Table 15).

Rod S/N	Type Fuel	Measured at End of Life		Calculated	
		Depletion (10 ²⁰ f/cc)	Burnup (MWD/MT)	Depletion (10 ²⁰ f/cc)	Burnup (MWD/MT)
<u>Based on ¹³⁹La</u>					
0205071	Thoria	3.85	17,720	4.27	19,670
	Binary	10.39	48,630	11.56	54,090
1606710	Thoria	0.13	560	0.14	630
	Binary	0.83	3,670	0.86	3,780
<u>Based on ¹⁴⁸Nd</u>					
0205071	Thoria	4.04	18,610	4.27	19,670
	Binary	10.55	49,390	11.56	54,090
1606710	Thoria	0.13	580	0.14	630
	Binary	0.86	3,640	0.86	3,780

5.3 Iodine and Cesium Analysis of the Fuel Cladding

Stress corrosion cracking of metallic components, such as the Zircaloy-4 cladding, has historically been a problem concerning reactor safety and fuel performance. Iodine and cesium have been identified as possible corrosive agents causing stress corrosion cracking. Under reactor conditions, fission product iodine can react with zircaloy. Measurement of fission product iodine and cesium inventories in the fuel rod samples was performed to determine the fraction of these nuclides that migrate to the gap region and into the cladding. (The gap region was defined as the fuel-cladding gap, fuel cracks, and the interconnected, open porosity in the fuel.) The quantity of fission products I-129 and Cs-137 in the fuel-cladding gap and, separately, dissolved in the fuel and cladding, were determined for two seed fuel rods and two standard blanket fuel rods (Richardson et al. 1987, WAPD-TM-1606).

Fission products I-129 and Cs-137 deposited in the gap were determined by immersing the fuel and cladding separately in 2N HCl for 30 minutes. Ultrasonic vibration was applied to aid in dissolving any iodine and cesium deposits from the cladding surface only. Fuel particles remaining in the cladding and fuel wash solution were analyzed for Cs-137 by gamma-ray spectroscopy. The I-129 was precipitated, and the precipitate was counted for I-129 with a calibrated lithium-drifted germanium detector (Richardson et al. 1987, WAPD-TM-1606, pp. 44-45).

The I-129 and Cs-137 inventory in fuel and cladding were determined using similar techniques described above. Results for the analyses are presented in Tables 5-11 and 5-12. All analyses demonstrate that almost all the I-129 and Cs-137 stayed in the fuel rather than migrating to the gap where they could have induced accelerated corrosion and cracking. These results agree with the nondestructive examination findings with the REX that no gross cladding defects resulted from reactor operations (see Table 5-2).

Table 5-11. Concentration of I-129 in Light Water Breeder Reactor fuel rod cladding and fuel pellets ($\mu\text{g/g}$) (Richardson et al. 1987, WAPD-TM-1606, Table 16).

<u>Rod S/N</u>	<u>Type Fuel</u>	<u>Sample No.*</u>	<u>Cladding Wash</u>	<u>Fuel Wash</u>	<u>In Cladding</u>	<u>In Fuel</u>
<u>Seed Region Fuel</u>						
0205071	Thoria	1A	N.D.	N.D.	N.D.	123.2
		1B	N.D.	N.D.	N.D.	135.7
	Binary	2A	N.D.	0.1	N.D.	309.3
		2B	N.D.	0.2	N.D.	317.9
0507672	Binary	1	N.D.	N.D.	N.D.	261.9
	Binary	2	N.D.	N.D.	N.D.	335.4
<u>Blanket Region Fuel</u>						
1606710	Binary	1A	0.4	0.2	N.D.	130.4
		1B	N.D.	N.D.	N.D.	153.3
	Binary	2	N.D.	N.D.	N.D.	136.0
1105717	Thoria	1	N.D.	N.D.	N.D.	112.8
	Binary	2	N.D.	N.D.	N.D.	149.3

* A and B samples were obtained from adjacent fuel rod sections.
N.D. = Not Detected

Table 5-12. Concentration of Cs-137 in Light Water Breeder Reactor fuel rod cladding and fuel pellets ($\mu\text{g/g}$) (Richardson et al. 1987, WAPD-TM-1606, Table 17).

<u>Rod S/N</u>	<u>Type Fuel</u>	<u>Sample No.*</u>	<u>Cladding Wash</u>	<u>Fuel Wash</u>	<u>In Cladding</u>	<u>In Fuel</u>
<u>Seed Region Fuel</u>						
0205071	Thoria	1A	0.1	1.8	2.8	1609.8
		1B	0.1	3.0	3.1	527.8
	Binary	2A	0.2	4.3	5.9	1261.5
		2B	0.2	4.4	6.5	294.0
0507672	Binary	1	0.2	2.4	5.8	1355.2
	Binary	2	**	**	6.2	1317.0
<u>Blanket Region Fuel</u>						
1606710	Binary	1A	0.6	0.4	2.8	622.1
		1B	0.1	0.6	N.M.	812.7
	Binary	2	0.1	0.4	2.9	571.6
1105717	Thoria	1	1.9	0.4	1.5	234.5
	Binary	2	0.1	0.7	1.8	622.0

* A and B samples were obtained from adjacent fuel rod sections.
** 0.2 $\mu\text{g/g}$ was recorded for a combined cladding and fuel wash solution.
N.M. = Not Measured

6. SHIPPING AND STORAGE

6.1 Shipment from Shippingport to Expanded Core Facility

After the reactor was shut down, the reactor was defueled, and the fuel modules were partially disassembled then loaded into modified M-130 casks and shipped to ECF in 10 shipments (4 shipments of blanket modules, 2 of seed modules, and 4 of reflector modules) (Selsley 1987b, WAPD-TM-1553, p. 7). To ensure criticality control during defueling, potassium tetraborate was added to the reactor vessel and canal water to about 4,200 parts per million (ppm) by weight of natural boron (Selsley 1987a, WAPD-TM-1551, p. 111).

Disassembly of the modules at Shippingport APS was required to permit them to fit inside the M-130 shipping containers. The seed assemblies were modified by removing the support shaft, balance piston, and buffer cylinder. Lifting studs were installed, and a shipping plate was attached to them. The shipping plate was designed to accommodate a lift adapter used at ECF. The modified seed module received at ECF is shown in Figure 6-1 (Hodges 1987, WAPD-TM-1601).

To reduce the size of each blanket module, the support tube and seal block assembly at the top of the module and the guide tube extension and stub tube assembly at the bottom of the module were removed. For top end disassembly, the instrumentation tubes were cut, and the blanket support tube was unbolted. At the bottom end, the six guide tube extension bolts were severed, and the stub tube and guide tube extension were removed. A shipping plate was installed at the top of the module to provide structural support and to accommodate the lift adapter. The modified blanket module received at ECF is shown in Figure 6-2 (Hodges 1987, WAPD-TM-1601).

Reflector modules were modified by removing the top seal block assembly. As with the seed and blanket assemblies, a shipping plate was attached to the top of the reflector module to provide structural support and accommodate the lift adapter. The modified reflector module received at ECF is shown in Figure 6-3 (Hodges 1987, WAPD-TM-1601). Module holders for seed, blanket, and reflector modules are shown in Figures 6-4 through 6-6.

The modified M-130 container used to ship the assemblies is shown in Figure 6-7 (Williams 1987, WAPD-TM-1611). The M-130 is an upright, right circular cylinder, with outside dimensions of 84 in. in diameter by 158 in. high. Inside dimensions are 55 in. in diameter by 132 in. high (Selsley 1987b, WAPD-TM-1553, Appendix A). Each of the M-130 containers was fitted with module holders, which were designed to accommodate the largest of each module type within the respective containers. The M-130s modified for blankets used special inserts for the Type I and Type II blanket modules; the M-130s modified for reflectors used special inserts for the Type V reflectors (Selsley 1987b, WAPD-TM-1553, p. A1-4). A recessed head was used for LWBR shipping because of module length and the need for specified holddown devices required in the event of a container accident. M-130 container modifications were reviewed by the Nuclear Regulatory Commission, and a certificate of compliance was issued (Selsley 1987b, WAPD-TM-1553, p. 7).

An A-frame on the railcar served to suspend the M-130 slightly from the deck of the railcar and functioned as a shock absorber (Figure 6-8). Energy absorbers were also fastened to the top of each M-130 container (Selsley 1987b, WAPD-TM-1553).

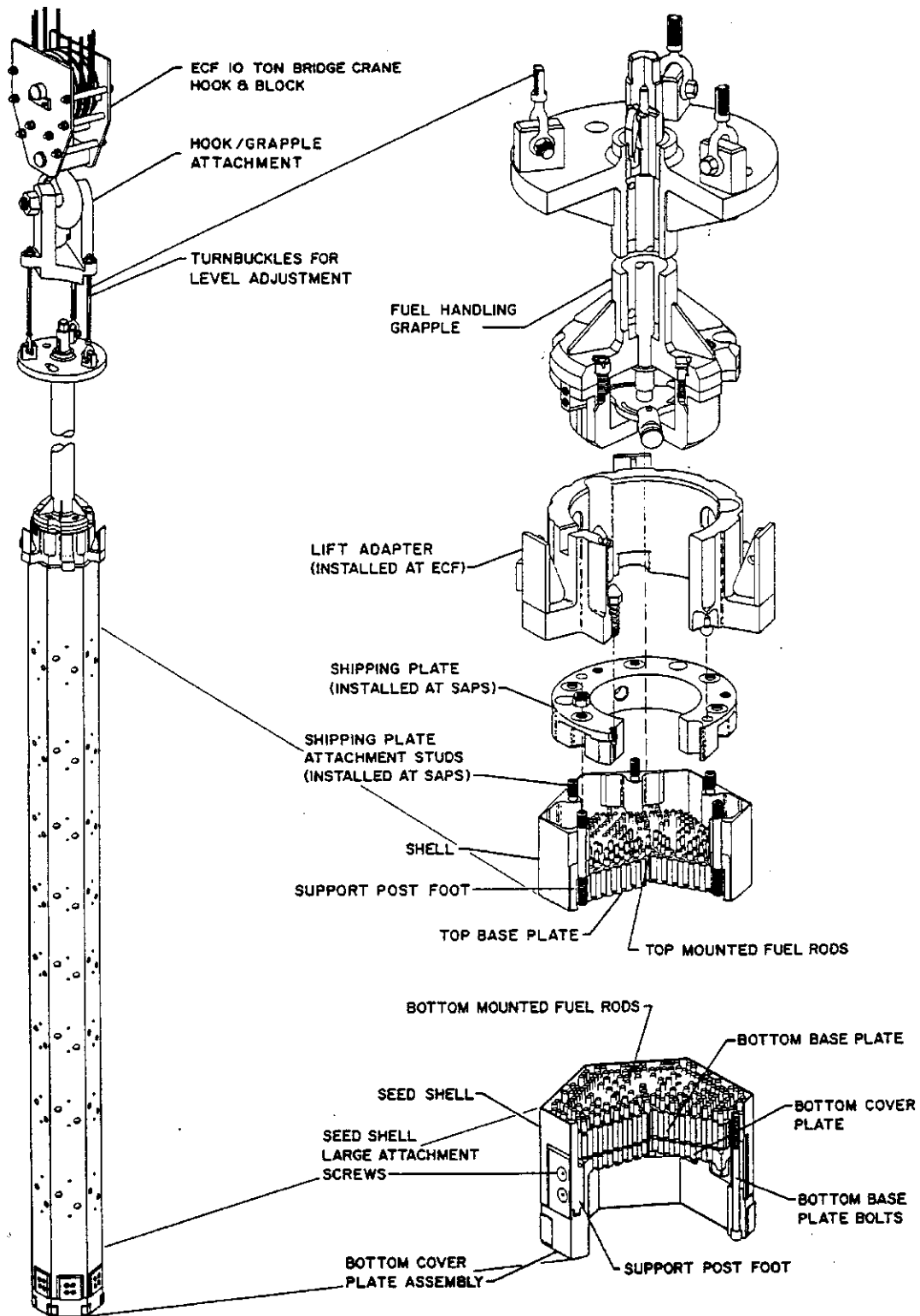

Figure 6-1. Light Water Breeder Reactor seed module as received at the Expanded Core Facility (Hodges 1987, WAPD-TM-1601, Figure 1-1).

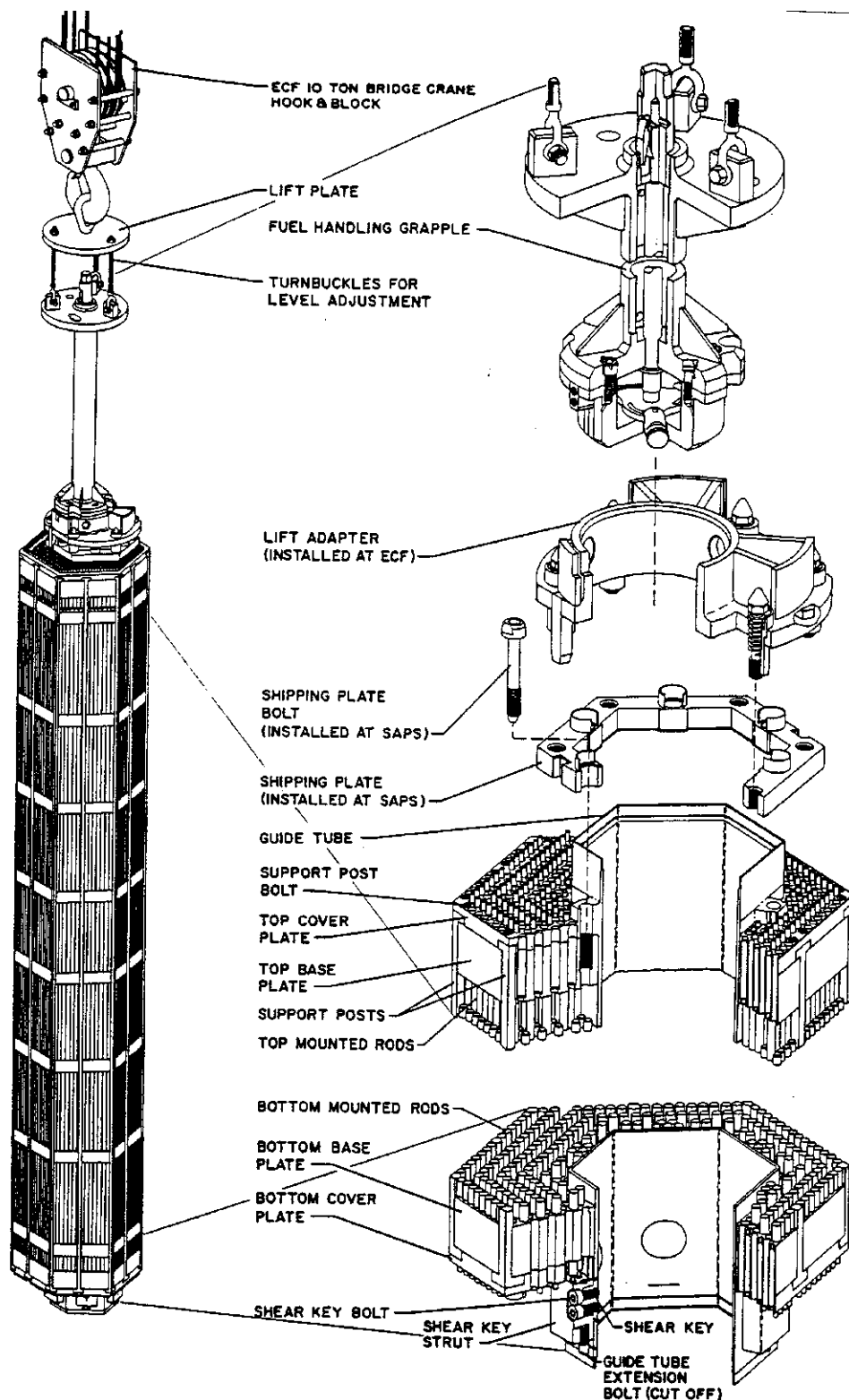

Figure 6-2. Light Water Breeder Reactor blanket module as received at Expanded Core Facility (Hodges 1987, WAPD-TM-1601, Figure 1-2).

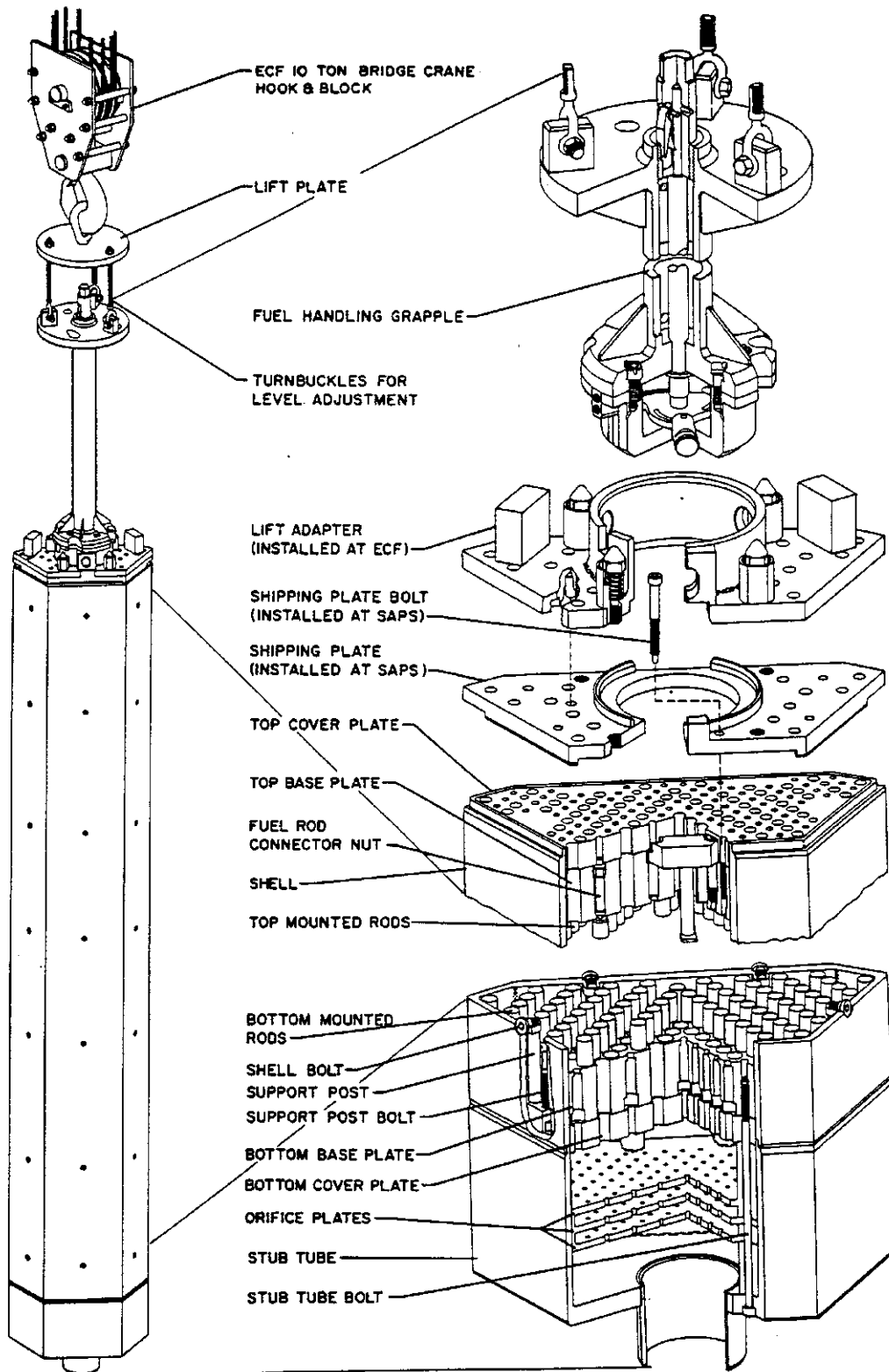

Figure 6-3. Light Water Breeder Reactor reflector module as received at Expanded Core Facility (Hodges 1987, WAPD-TM-1601, Figure 1-3).

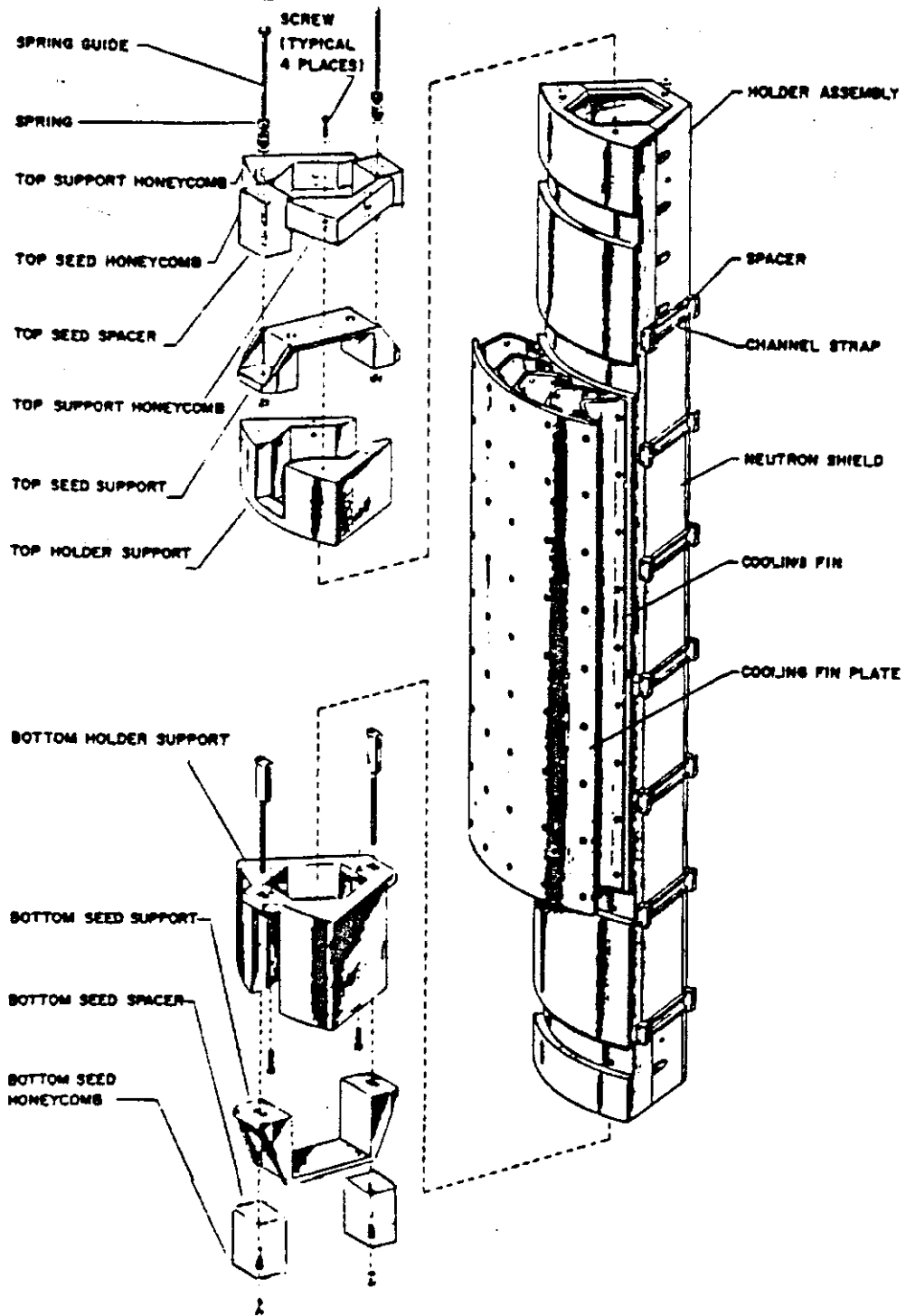

Figure 6-4. Module holder for seed modules (Selsley 1987b, WAPD-TM-1553, Figure A1-3).

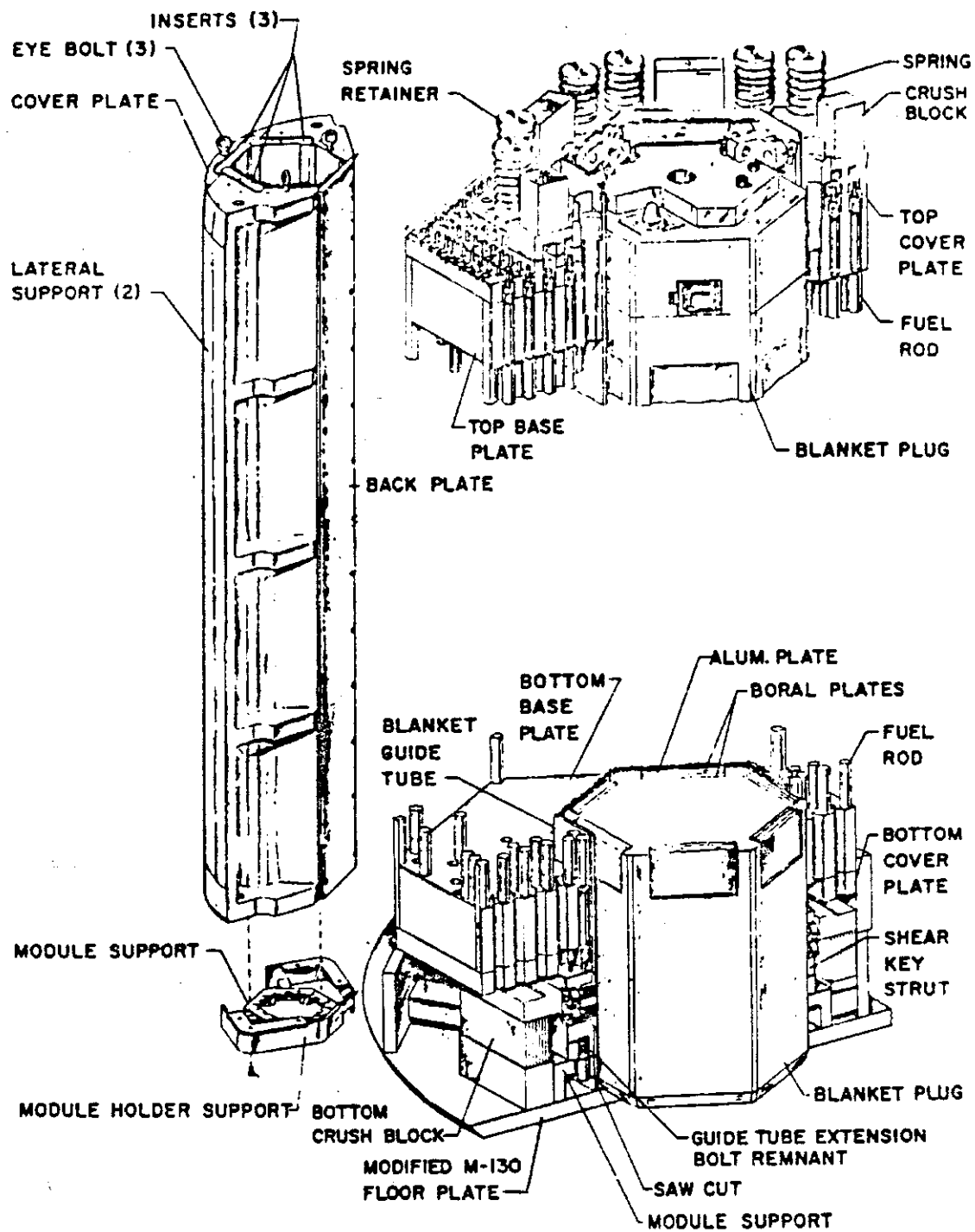

Figure 6-5. Module holder for blanket modules (Selsley 1987b, WAPD-TM-1553, Figure A1-4).

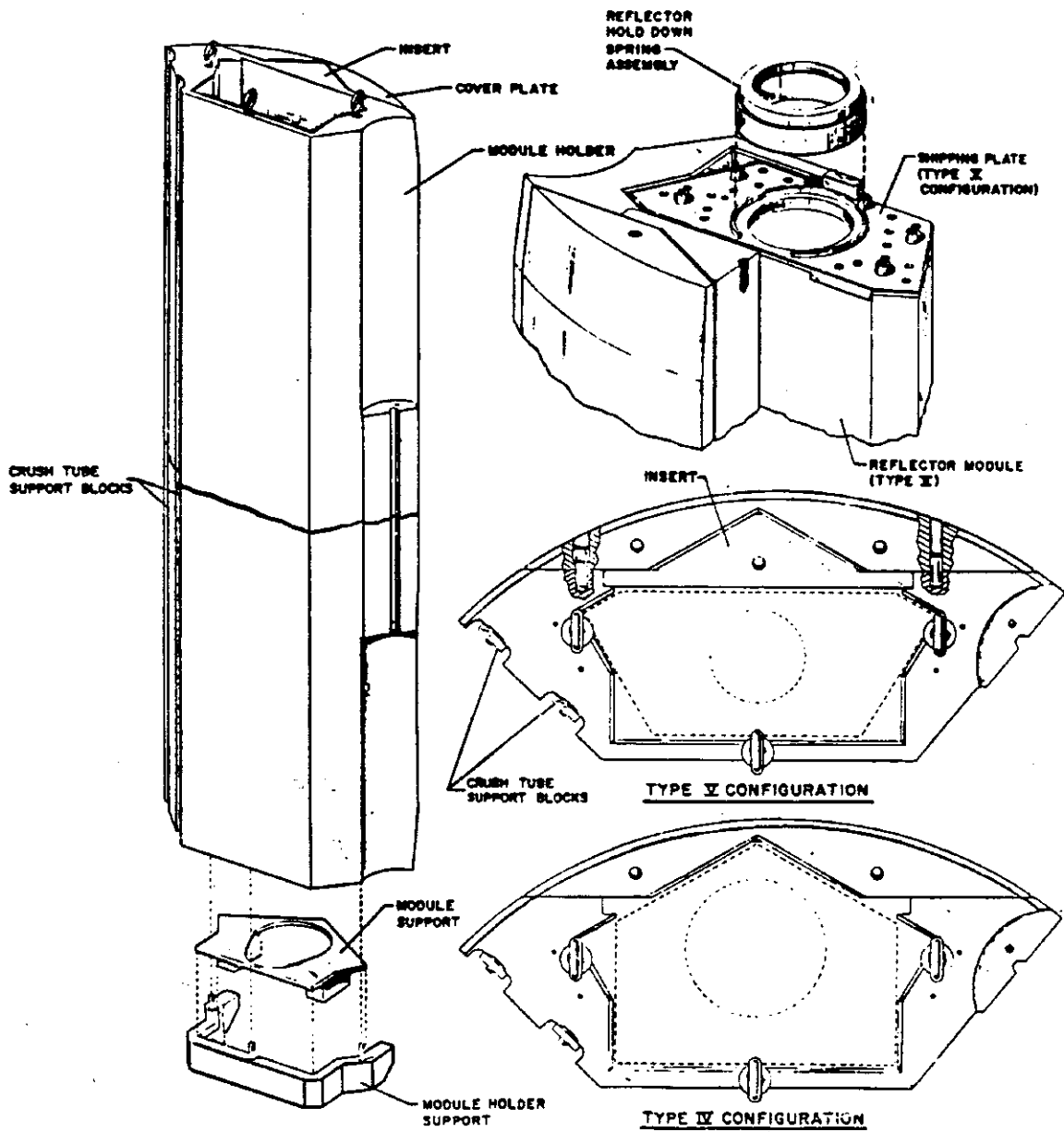

Figure 6-6. Module holder for reflector modules (Selsley 1987b, WAPD-TM-1553, Figure A1-5).

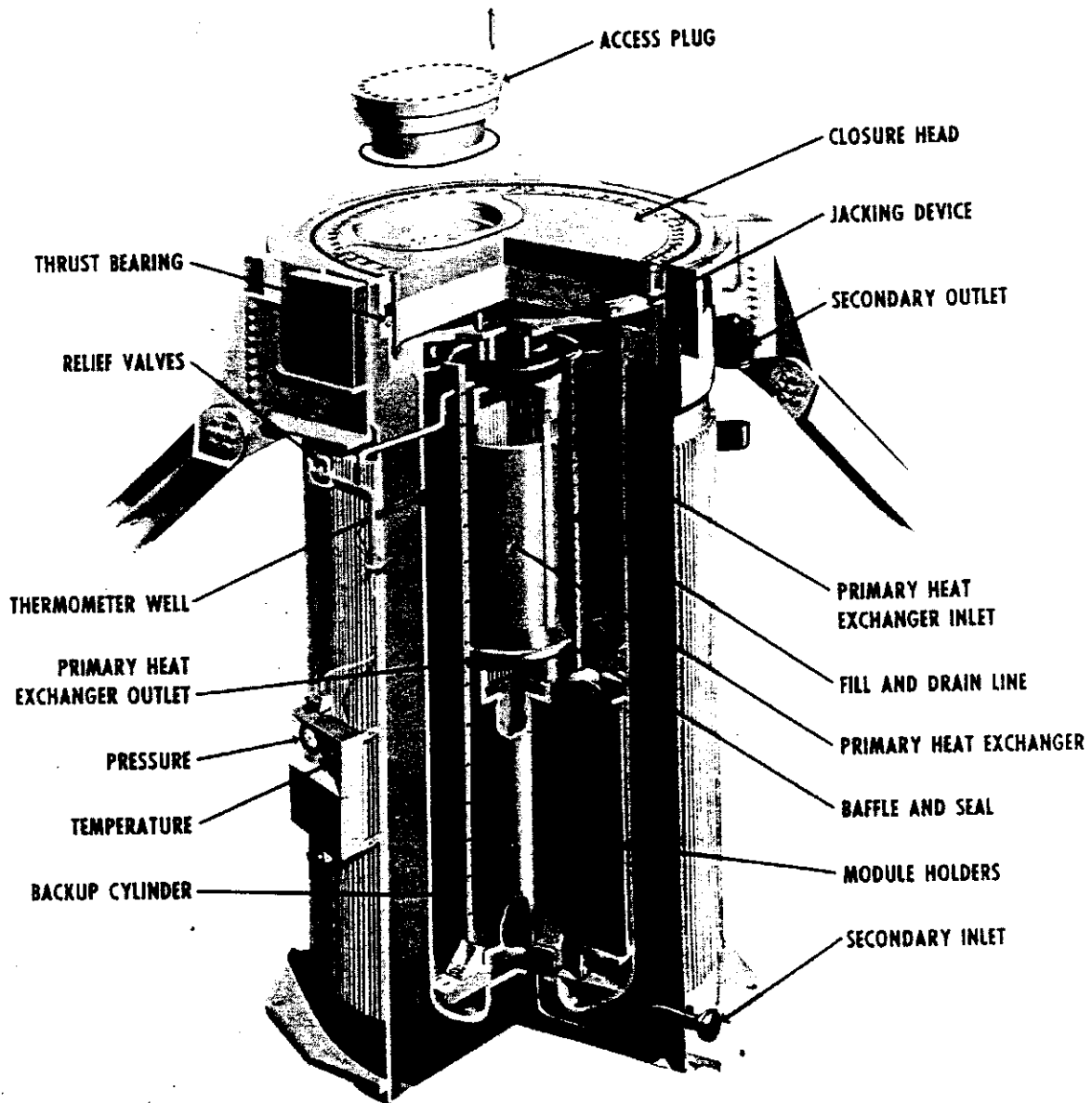

Figure 6-7. M-130 shipping container as modified for Light Water Breeder Reactor fuel shipments (Williams 1987, WAPD-TM-1611, Figure 8).

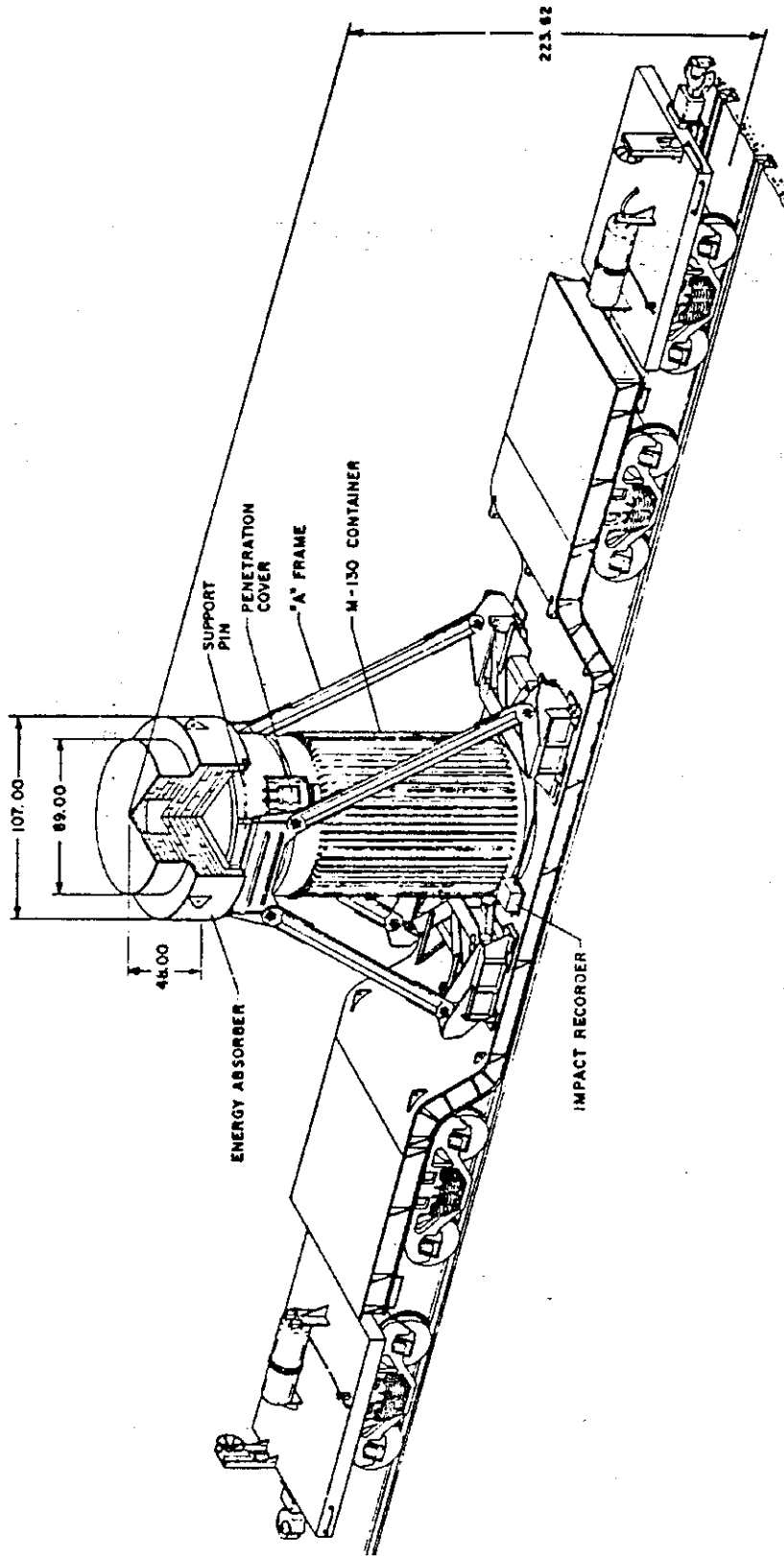

Figure 6-8. M-130 irradiated fuel shipping system (Selsley 1987b, WAPD-TM-1553, Figure A1-1).

M-130 preparations for shipment were as follows:

1. Loaded containers were flushed with nonborated water to reduce boron residue. Surfactant was added to the water used to flush the seed module container to enhance drainage from horizontal surfaces that were not present in other containers.
2. Containers were filled with neon gas.
3. Decay heat generation values for the seed shipments and for the first blanket shipment were obtained by performing a calorimetric test (Selsley 1987b, WAPD-TM-1553).

All shipments were completed successfully with no damage to fuel modules. Details for the shipping operations from Shippingport to ECF are provided in Selsley 1987b (WAPD-TM-1553).

6.2 Handling, Disassembly of Selected Modules, and Storage at Expended Core Facility

The modules were sent to ECF (with shipping plates attached) in 10 shipments. Upon receipt, the internal atmosphere of each M-130 shipping cask was sampled for fission gases to determine the integrity of the fuel rod cladding, and the modules were placed in individual storage liners. The tests indicated that all shipments were completed without damage to the fuel cladding in any of the fuel modules (Hodges 1987, WAPD-TM-1601, p. 2-1).

The shipping container was transferred from the railcar to the water pit at ECF, and the fuel modules were transferred individually to one of two water pits for storage in the module storage racks. The fuel was stored in the ECF water pits for 3 to 5 years (depending on the liner). The fuel module grapple used to lift the modules is shown in Figure 6-9. The ECF water pits are shown in Figure 6-10. All LWBR modules were individually installed into a liner for storage purposes at ECF. Liners were constructed of stainless steel and were 25.50 in. in diameter and had a length, with the closure head installed, of 157.80 in. (Hodges 1987, WAPD-TM-1601, p. 3-1).

Twelve modules (four seed, four reflectors, and four blankets) were remotely disassembled underwater to free the core components and fuel rods (Greenberger and Miller 1987, WAPD-TM-1608, p. 15). Ten of the modules had their baseplates cut off, and two of the modules (a reflector IV-4 and a seed II-3) were deshelled, then had their baseplates cut off. The two modules were deshelled so that the exposed fuel rods could be visually examined and could free the module structural components for examination (including shells, grid sections, and grid fasteners). Deshelling took place in the module disassembly apparatus. Baseplate cutoff for all 12 modules was performed with the cutoff system, which cut off both ends of the module and severed the structural components to free all fuel rods (Greenberger and Miller 1987, WAPD-TM-1608). About 1000 rods were then removed from the 12 modules using the rod removal system and were later examined for EOL properties as described in Section 5.

Before cutting the 12 modules designated for EOL rod examination, remnant clamps were installed and the bandsaw was aligned for cutting at the top and bottom module baseplates. The cut location was approximately in the center of each baseplate, and the resulting module lengths after cutting ranged from about 116 to 124 inches (Greenberger and Miller 1987, WAPD-TM-1608, p. 51). Fuel assemblies excluded from the EOL program were transported from ECF to INTEC while examinations of the selected LWBR fuel assemblies were in progress (Hodges 1987, WAPD-TM-1601, p. 1-2).

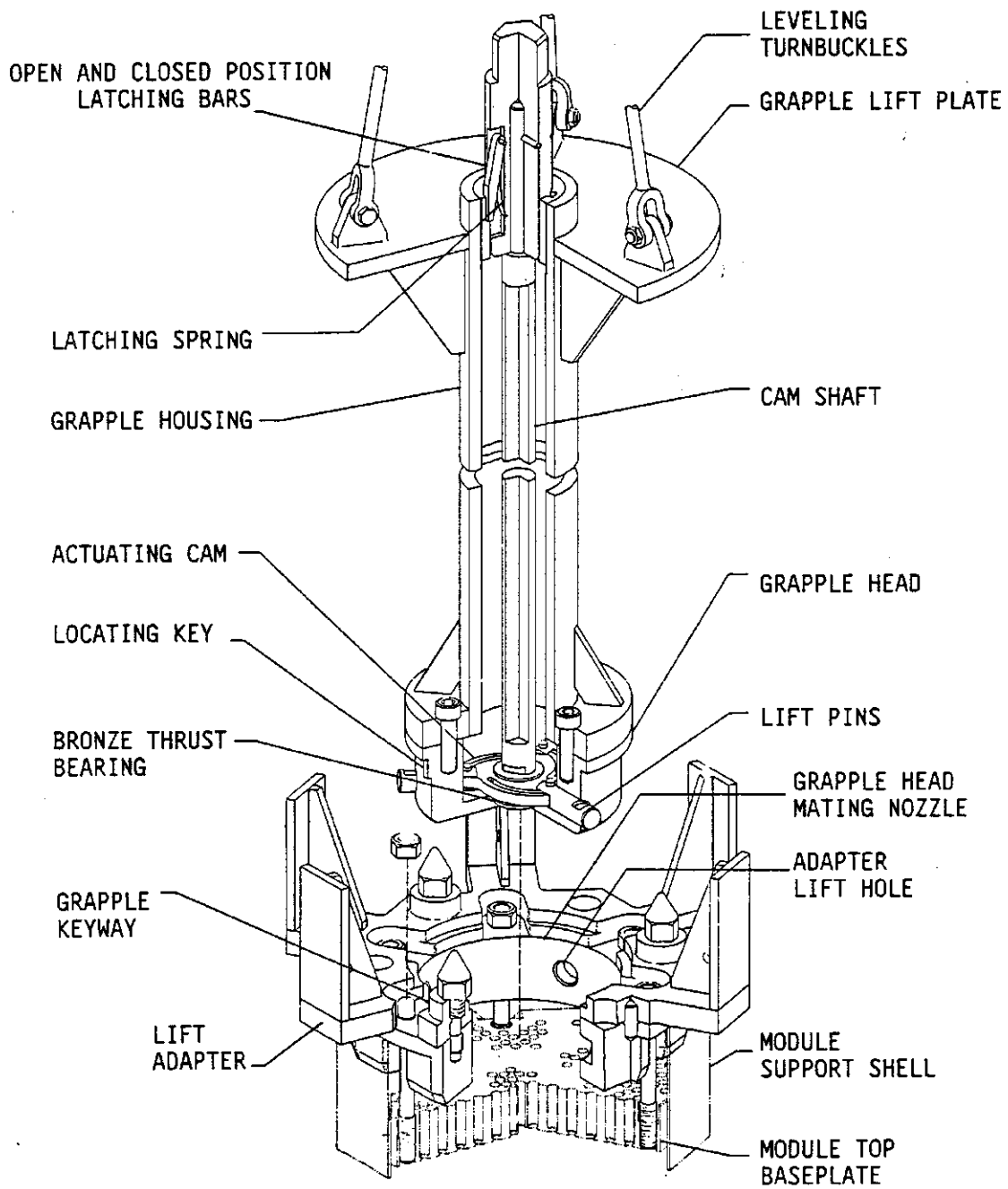

Figure 6-9. Light Water Breeder Reactor fuel module grapple shown with seed module (Greenberger and Miller 1987, WAPD-TM-1608, Figure 8).

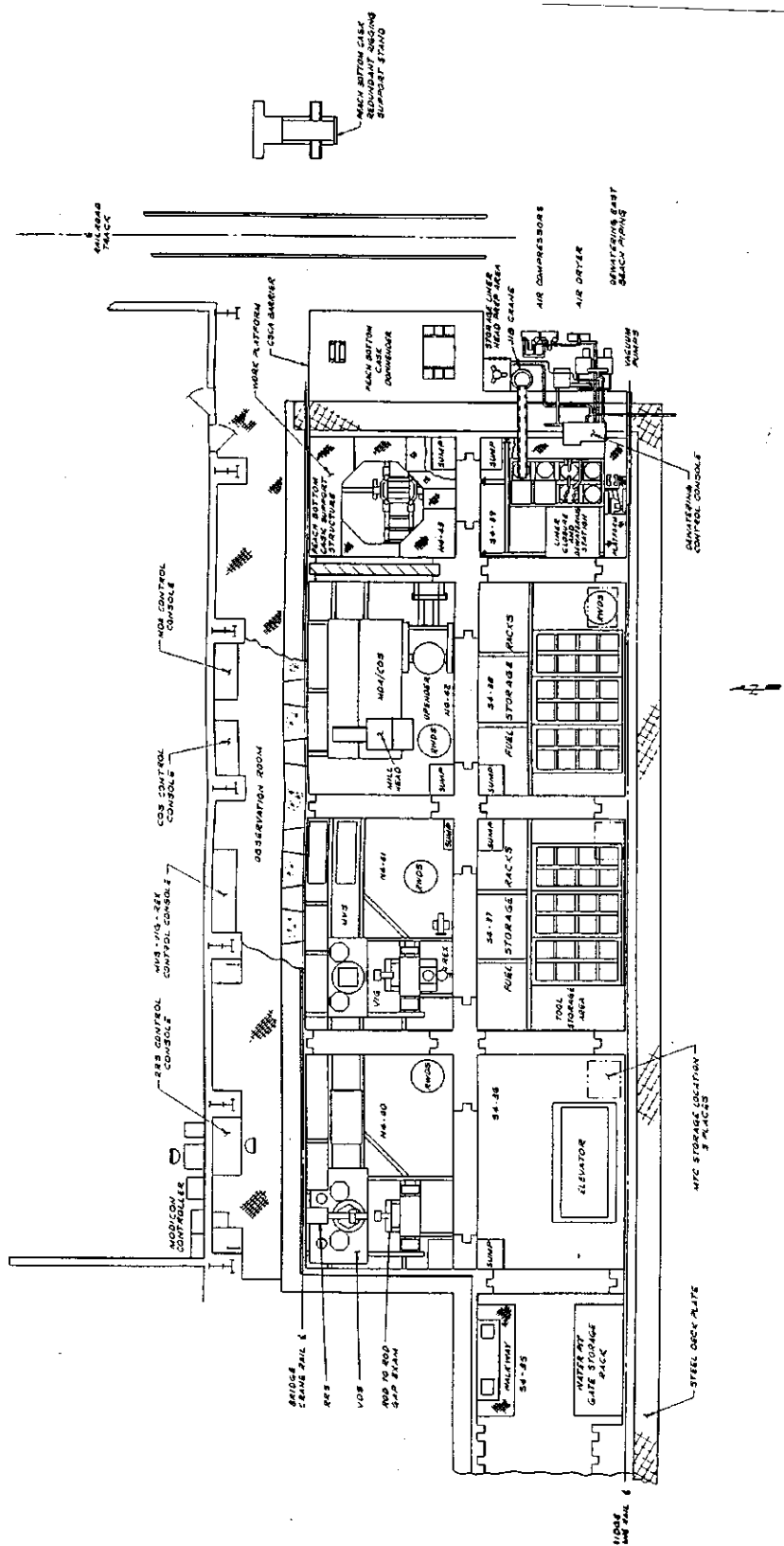

Figure 6-10. Area of the Expended Core Facility water pits used for Light Water Breeder Reactor program (Hodges 1987, WAPD-TM-1601, Figure 1-4).

The cut modules were secured with stabilization clamps, which were designed to provide a means for vertical lifting and handling of the cutoff modules. The stabilization clamp assembly used for the seed modules is shown in Figure 6-11. Similar stabilization clamp assemblies were used for the blanket and reflector modules. The drawing numbers for the stabilization clamps, lift adaptors, modules, and rod storage liner are identified in Cole (2001).

After each module processing operation, the clamped modules were returned to their designated storage liners. When all scheduled module examinations were completed, the storage liners were transferred to the Liner Closure Station for final closure head installation and water removal.

6.2.1 Water Removal at Expended Core Facility

Fuel liner blowdown removed the bulk water from the liner. A schematic of the liner blowdown system is presented in Figure 6-12. The water blowdown process occurred under water. The liner head was bolted onto the storage liner. Compressed air was forced through the blowdown system until the flowmeter downstream of the blowdown tank registered 450 gallons, ensuring the fuel storage liner was empty of bulk water.

Air circulation through the fuel storage liner was the second fluid process. A schematic of the liner air circulation system is presented in Figure 6-13. Dry compressed air was pumped for 20 minutes at about 17 cfm through the air dryer system, down through the fuel liner and filter system, and into the blowdown tank (Hodges 1987, WAPD-TM-1601). The forced air displaced the water out of the storage liner through the liner's standpipe, the drain fitting, and the drain umbilical tool, forcing the water out. Once the bulk amount of water was removed from the liner, only droplets of water remained on all the fuel and liner surfaces.

Residual water was removed using a vacuum pump, then the liner was backfilled with neon gas. Leak testing with neon gas to 150% of the maximum postulated liner pressure was performed underwater for 20 minutes to ensure that the storage liners were adequately sealed for shipment and storage. The dried and sealed liner was then transferred to the Peach Bottom Cask shipping container for subsequent shipment to INTEC for underground (dry) storage (Hodges 1987, WAPD-TM-1601).

The Part C Fuel Receipt Criteria for all the storage liners includes the certification checklists for the liners. The ECF Shift Supervisor and LWBR Engineering manager were required to check a box on a form indicating that they checked the following items for each liner: liner identification, module identification, liner vendor certification, fission product leakage certification (including water pit sample analysis), no liquid water in liner, and neon gas backfill of the liner.

6.2.2 Shipment from Expended Core Facility to INTEC

Two types of fuel storage liners (rod and module) were fabricated for the LWBR fuel disposal program. The exterior of all storage liners was a stainless steel cylindrical shell with an outer diameter of 25.50 in. and a length, with the closure head installed, of 157.80 in. (Hodges 1987, WAPD-TM-1601, p. 3-1). The exteriors of all the liners are identical, except for the unique labels painted on the top of the liner closure heads. Video tapes showing the loading of the liners into the Peach Bottom transport casks confirmed that all the labels were legible when the casks were loaded at ECF for shipment to INTEC for dry storage.^c

c. Olson and McCardell viewed the tapes; tapes are in records storage with other LWBR records with Vicky Boyer at INTEC.

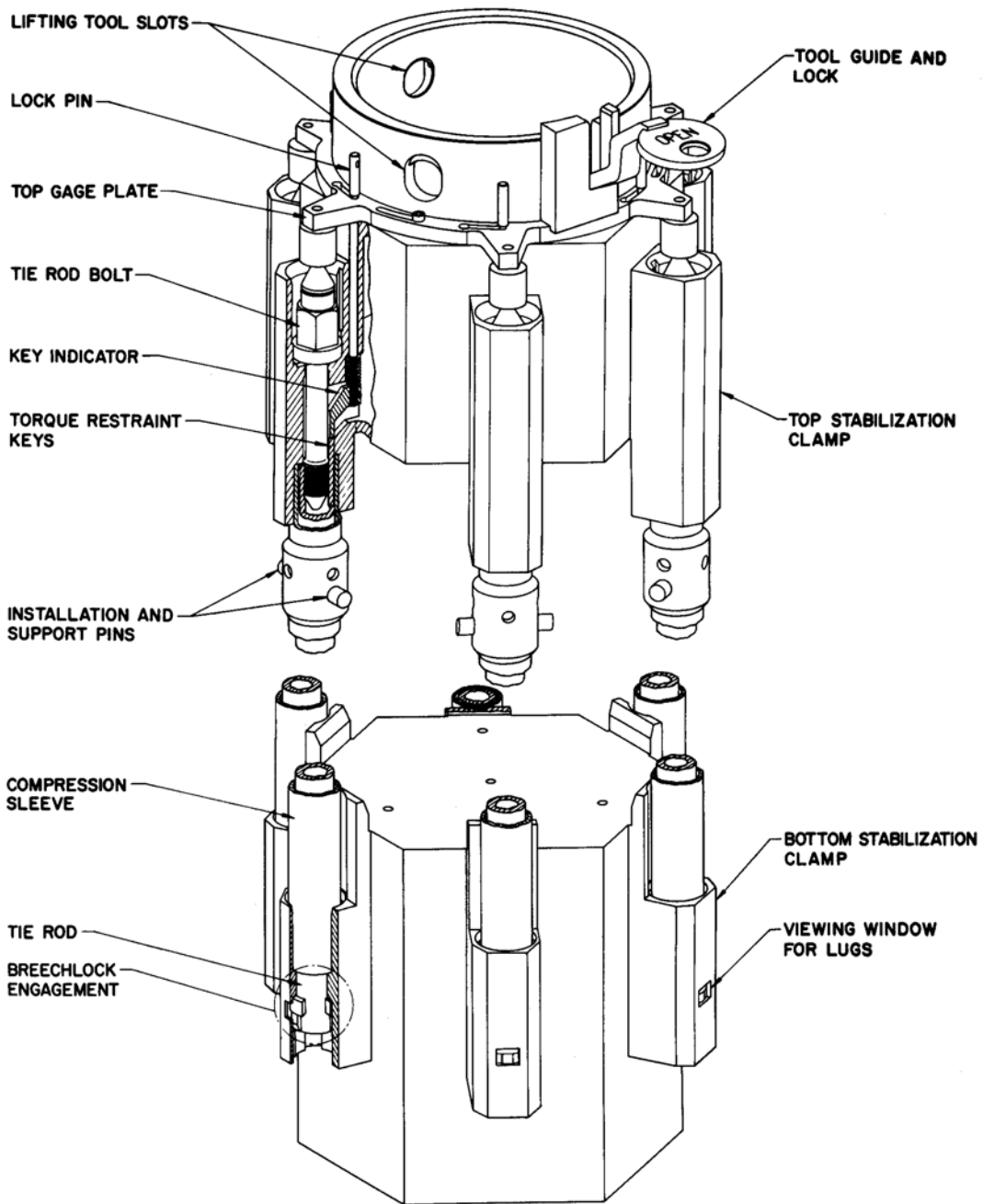

Figure 6-11. LWBR Seed Stabilization Clamp (Greenberger and Miller 1987, WAPD-TM-1608, Figure 27).

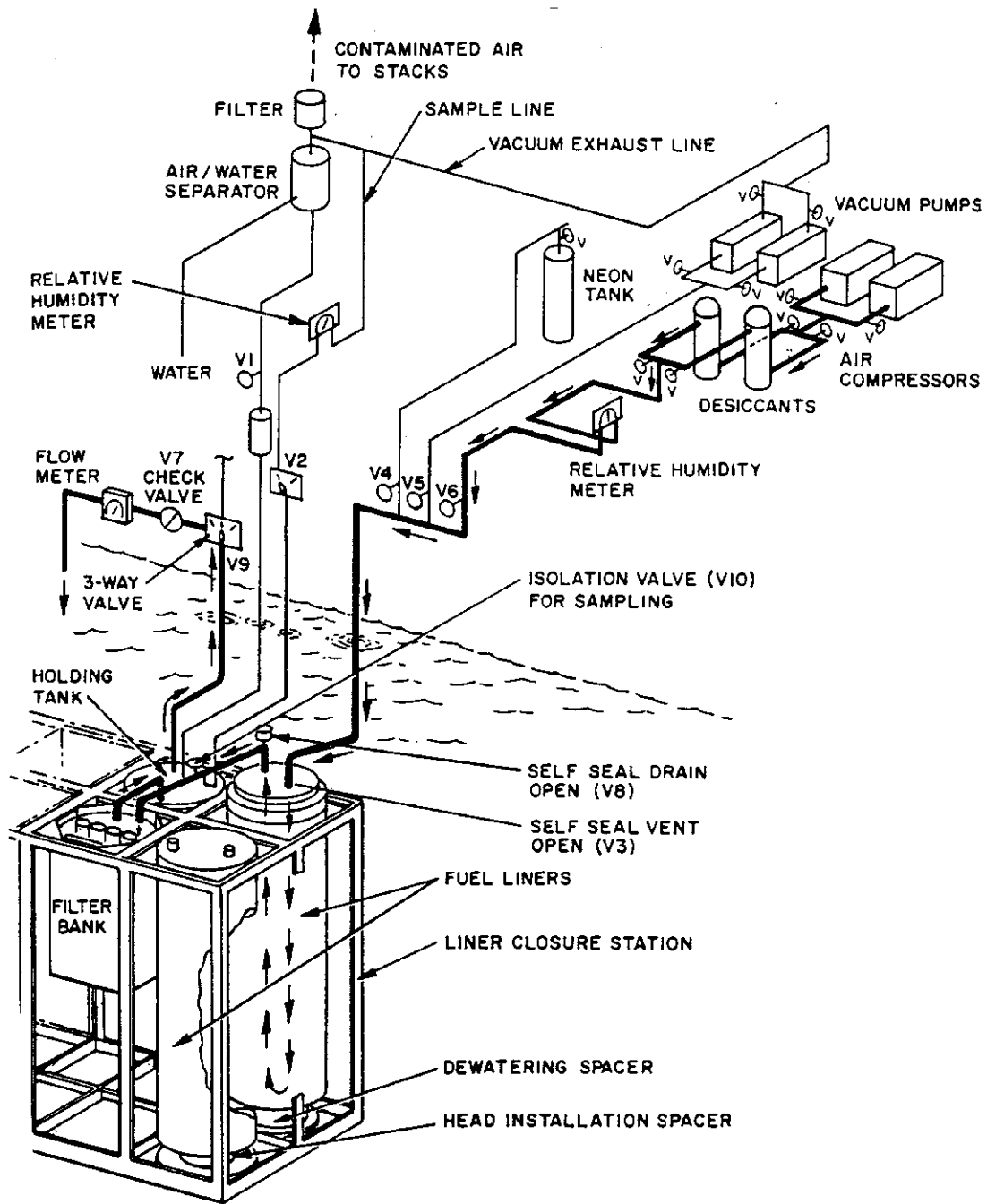

Figure 6-12. Light Water Breeder Reactor storage liner blowdown schematic (Hodges 1987, WAPD-TM-1601, Figure 3-11).

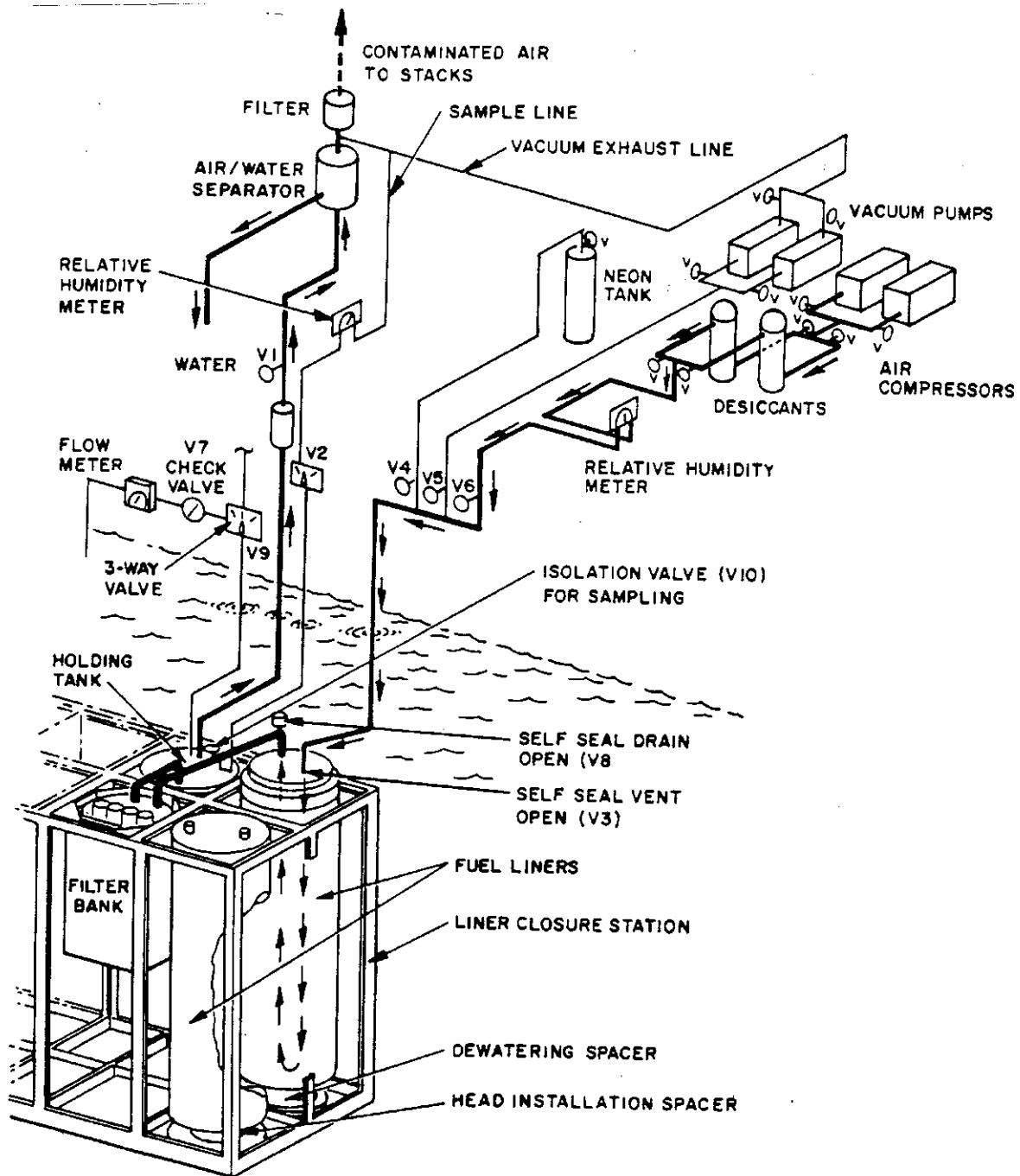

Figure 6-13. Light Water Breeder Reactor storage liner air circulation schematic (Hodges 1987, WAPD-TM-1601, Figure 3-15).

The interior of the rod storage liners had tube bundle inserts to house the individual fuel rods. The interior of the module storage liners had features configured to the various module cross sections. A typical LWBR fuel module storage liner is shown in Figure 6-14. Each module type had a corresponding storage liner type because of the vastly different sizes and cross-sectional shapes of the LWBR fuel modules. Liner internals were fabricated to accept both as-received and cut modules. Liners containing LWBR assemblies and loose rods were shipped from ECF to INTEC in a Peach Bottom Cask from December of 1985 until the last of the test rods were packaged and shipped in 1987 (Fuel Receipt Criteria Package B and C).

The storage liner preparation process included monitoring for fission products (Cs-137 and Cs-134) and fission gas (Kr-85) to indicate the possible existence of through-clad defects in fuel rods. No through-clad defects were indicated by fill water analysis for cesium when the modules arrived at ECF from Shippingport. However, positive indications were discovered during ECF liner preparations of two of the 12 LWBR seed modules (3-5 and 3-6) at initiation of the neon gas bleed cycle (Hodges 1987, WAPD-TM-1601, p. 3-37). After further testing, it was determined that the results suggested that there were fuel rod cladding defects in seed Modules 3-5 and 3-6, although available data were insufficient to conclude that fuel rod defects actually existed in the modules (Hodges 1987, WAPD-TM-1601, p. 3-38). The mechanism that may have led to a cladding defect while the modules were in storage at ECF was not identified (Hodges 1987, WAPD-TM-1601, p. 3-39). The presence of through-clad defects in seed Modules 3-5 and 3-6 remains questionable (Hodges 1987, WAPD-TM-1601, p. 3-39). Part C of the Fuel Receipt and Storage papers confirms the potential for cladding defects:

For Seed 3-5: "An indication of radioactive gas was noted during initial bleedoff. A gas sample taken during neon bleedoff indicated 8×10^{-6} $\mu\text{Ci/mL}$ K-85...Further sampling indicated no presence of Krypton 85" (Shipment No. 27, S-3-5, November 1986).

For Seed 3-6: "A gas sample taken during neon bleedoff indicated 1.2×10^{-4} $\mu\text{Ci/mL}$ Kr-85...Further sampling indicated 3.2×10^{-5} $\mu\text{Ci/mL}$ Kr-85 at the initiation of vacuuming. However, sampling one hour into vacuuming and at the initiation of neon bleedoff indicated no presence of Krypton 85" (Shipment No. 28, S-3-6, December 1986).

6.3 Storage at INTEC

The 39 LWBR core modules, 7 containers of intact fuel rods, 1 container of cut fuel rods, and 1 container of an unirradiated seed (not discussed in this report) are presently in underground dry storage at CPP-749 in the upright position. The Dry Well Design for irradiated LWBR Fuel Storage Dry Wells is shown in Figure 6-15. The plot plan of LWBR fuel storage facility at CPP-749 is shown in Figure 6-16.

There are 27 Type A liners, which contain intact LWBR modules (i.e., modules from which no rods have been removed). Type A liners are configured to fit seed, standard, and power-flattening blanket, and reflector modules. There are 12 Type B liners, which contain partially derodded modules. Rods had been pulled from the various modules for testing and to access the rods chosen for testing. There are 7 Type C liners, which contain intact spent fuel rods (irradiated and unirradiated; unirradiated rods were used for calibration of instruments during postirradiation testing). Type C liners contain cells that are appropriately sized for the various diameters of the seed, blanket, and reflector rods. The exteriors of the liners are identical, except for their labels.

In addition to the Type A, B and C liners, there is one scrap can liner (Liner 15718), which contains sections and pieces of unirradiated rods and irradiated rods that have been cut up or punctured for testing purposes as well as unirradiated rods used for calibration. There are at least 22 containers

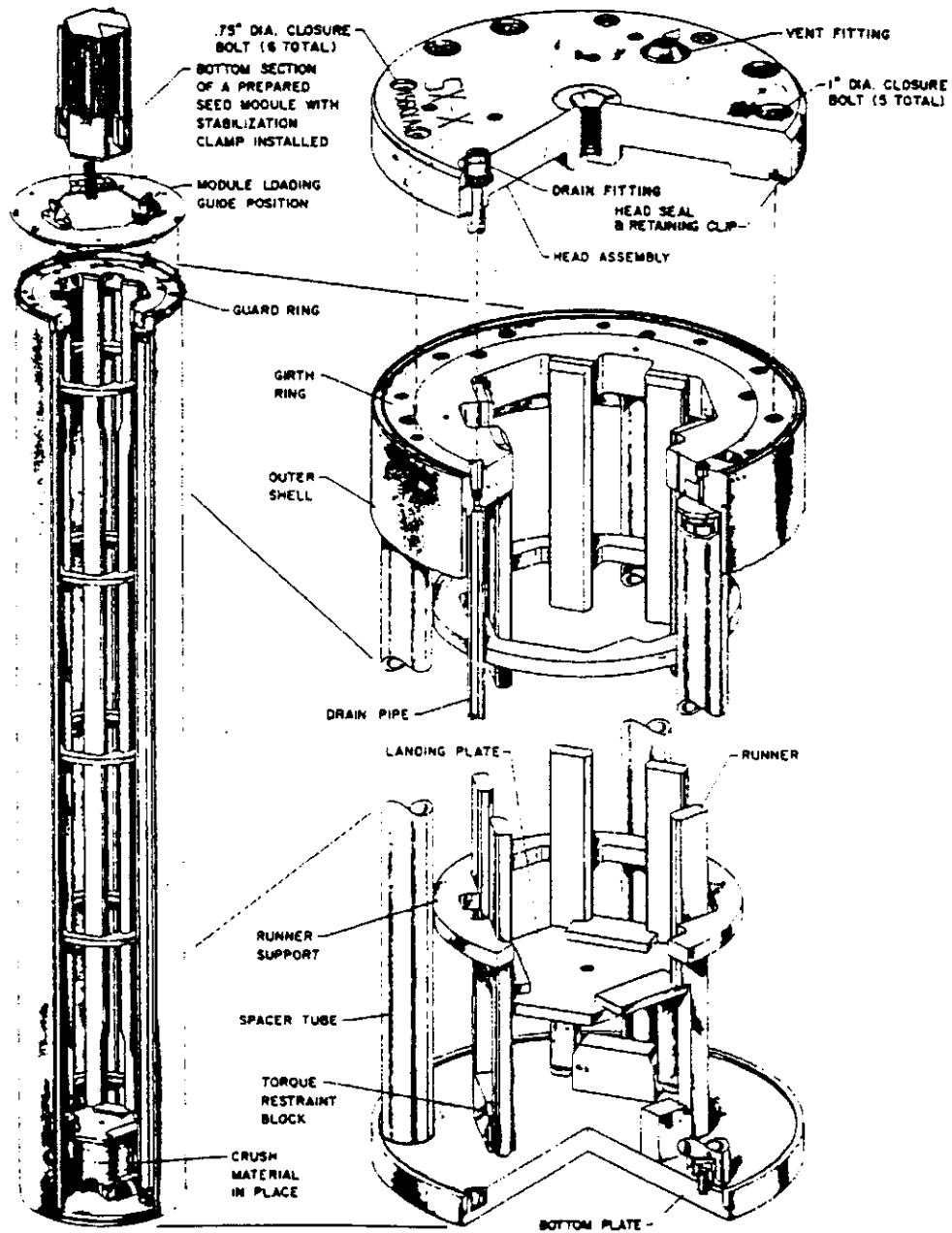
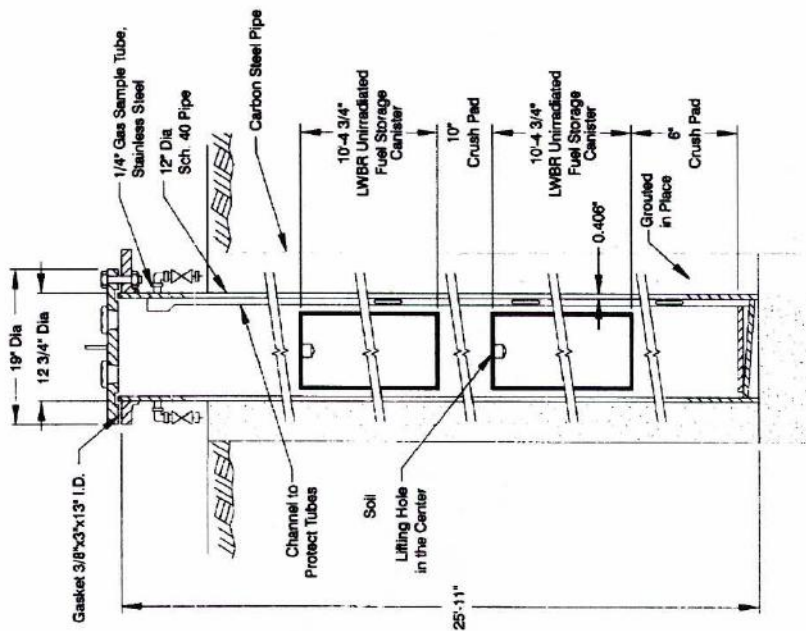
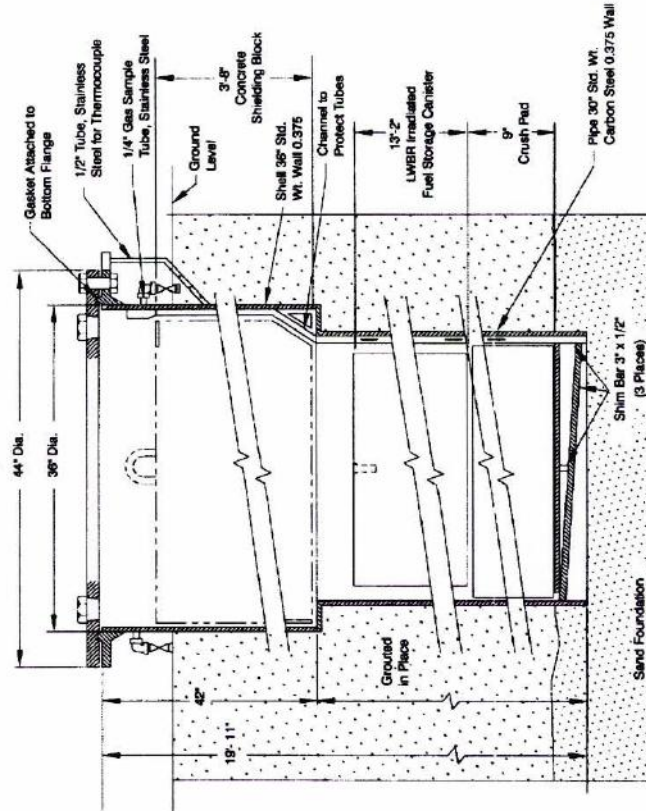

Figure 6-14. Typical Light Water Breeder Reactor fuel module storage liner (Hodges 1987, WAPD-TM-1601, Figure 3-1).

A. Unirradiated LWBR Fuel Storage Dry Well



B. Irradiated LWBR Fuel Storage Dry Well



GF00 0048

Figure 6-15. Section views of the dry well design for both unirradiated and irradiated Light Water Breeder Reactor fuel storage dry wells (INTEC Plant Safety Document 4.7A, 2002, Figure 4-7).

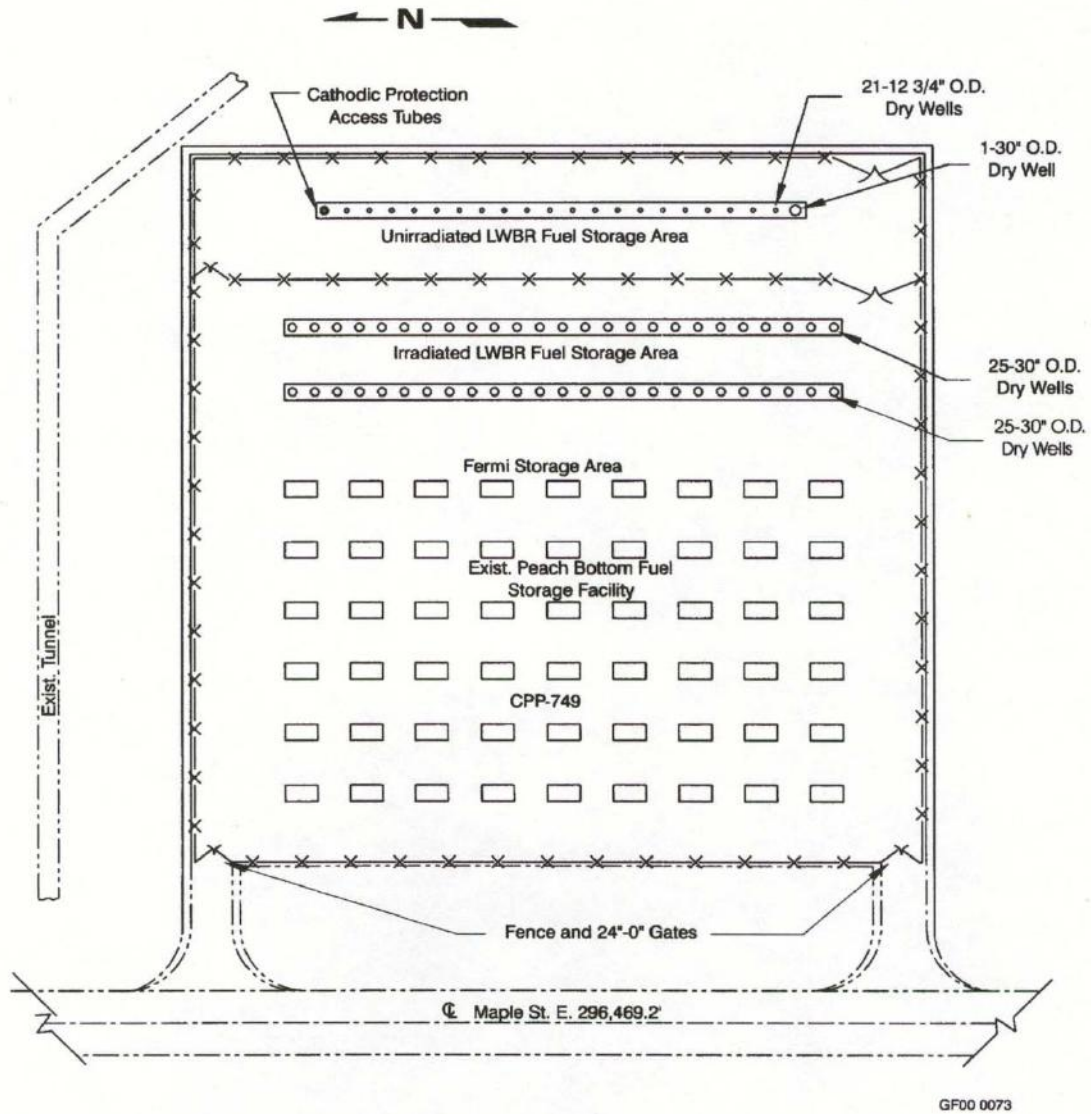

Figure 6-16. Plat plan of the Light Water Breeder Reactor fuel storage facility (INTEC Plant Safety Document, Section 4.7A, 2002, Figure 4-2).

within the scrap can, and these containers contain irradiated, unirradiated, intact, and cut fuel rods. Many of the rods have been run through a variety of tests, which may have altered their physical, chemical, and radiological status. The contents of the scrap can and information about the various tests that were conducted on the fuels inside the scrap can are provided in Appendix C.

Table 6-1 identifies the types of storage liners, how many rods are in each type of storage liner, the liner number, and the INTEC dry well number. Table 6-2 details the number and type of fuel rods for each Type C liner. Appendix D lists the rod serial numbers and isotopic contents (modeled) of each of the rods stored in the Type C liners.

Figures 6-17 through 6-23 identify the location of the rods within the Type C liners. Liner numbers, module serial numbers, and module types were confirmed March 18, 1998, by viewing a video of the loading of the Peach Bottom casks taken at ECF. Postirradiation isotopic data for the rods in the Type C liners are presented by rod in Part C of the Fuel Receipt Criteria.

Table 6-1. Types and contents of Light Water Breeder Reactor storage liners.

Dry Well Number	Module ID	Fuel Piece Serial Number	Liner Number	Liner Type ^a	Number of Rods Initially ^b	Number of Rods in "A" Liner ^c	Number of Rods Removed ^d	Number of Rods in "B" Liner ^d	Number of Rods in "C" Liner
I-7	S I-1	L-BB01-04	15601	B	619		50	569	
I-34	S I-2	L-BB01-05	15602	A	619	619			
I-37	S I-3	L-BB01-06	15603	A	619	619			
I-44	S II-1	L-BB01-09	15604	A	619	619			
I-12	S II-2	L-BB01-10	15605	A	619	619			
I-46	S II-3	L-BB01-13	15606	B	619		127	492	
I-6	S III-1	L-BB01-07	15607	B	619		42	577	
I-5	S III-2	L-BB01-08	15608	B	619		39	580	
I-11	S III-3	L-BB01-12	15609	A	619	619			
I-35	S III-4	L-BB01-11	15610	A	619	619			
I-39	S III-5	L-BB01-14	15611	A	619	619			
I-38	S III-6	L-BB01-16	15612	A	619	619			
I-15	B I-1	L-GR01-01	15613	A	442 ^e	442 ^e			
I-30	B I-2	L-GR01-02	15614	A	442 ^e	442 ^e			
I-13	B I-3	L-GU51-01	15615	B	443		52	391 ^e	
I-8	B II-1	L-GS01-01	15616	A	563 ^e	563 ^e			
I-50	B II-2	L-GS22-01	15617	B	564		84	480	
I-36	B II-3	L-GS01-02	15618	A	563 ^e	563 ^e			
I-3	B III-1	L-GT01-01 ^f	15619	A	632	632			
I-18	B III-2	L-GW52-01	15620	B	632		391	241 ^e	
I-16	B III-3	L-GT01-03	15621	A	633	633			
I-9	B III-4	L-GT01-04	15622	A	633	633			
I-28	B III-5	L-GT01-05 ^f	15623	A	633	633			
I-14	B III-6	L-GT22-03	15624	B	633		84	549	
I-2	R IV-1	L-RA01-06	15625	A	228	228			
I-27	R IV-2	L-RA01-02	15626	A	228	228			
I-41	R IV-3	L-RA01-10	15627	B	228		33	195	

Table 6-1. (continued).

Dry Well Number	Module ID	Fuel Piece Serial Number	Liner Number	Liner Type ^a	Number of Rods Initially ^b	Number of Rods in "A" Liner ^c	Number of Rods Removed ^d	Number of Rods in "B" Liner ^d	Number of Rods in "C" Liner
I-43	R IV-4	L-RA01-09	15628	B	228		76	152	
I-40	R IV-5	L-RA01-07	15629	A	228	228			
I-31	R IV-6	L-RA01-04	15630	A	228	228			
I-10	R IV-7	L-RA01-05	15631	A	227 ^e	227 ^e			
I-32	R IV-8	L-RA01-08	15632	A	228	228			
I-42	R IV-9	L-RA01-03	15633	B	228		57	171	
I-1	R V-1	L-RB01-07	15634	A	166	166			
I-4	R V-2	L-RB01-04	15635	A	166	166			
I-26	R V-3	L-RB01-06	15636	A	166	166			
I-17	R V-4	L-RB01-08	15637	B	166		37	129	
I-33	R V-5	L-RB01-03	15638	A	166	166			
I-29	R V-6	L-RB01-05	15639	A	166	166			
				Subtotal	17,288	11,690	1,072		
I-19	FR-B-1	Blanket ^g	15682 ^g	C ^g					175 ^g
I-20	FR-B2	Blanket ^h	15684 ^h	C ^h					144 ^h
I-48	FR-B3	Blanket ⁱ	15685 ⁱ	C ⁱ					243 ⁱ
I-21	FR-B4	Blanket ^j	15687 ^j	C ^j					62 ^j
I-45	FR-R1	Reflector ^g	15681 ^g	C ^g					127 ^g
I-47	FR-R2	Reflector ^h	15683 ^h	C ^h					80 ^h
I-22	FR-S1	Seed ⁱ	15686 ⁱ	C ⁱ					270 ⁱ
I-23		624 sections	15718						
				Total	17,288	11,690	1,072		1,101 ^k

a. WAPD-NRF(RE)FP-139 (Category A liners) and WAPD-NRF(RE)FP-192 (Category B liners)

b. Hecker 1979, WAPD-TM-1326, Table A-14 and A-15.

c. WAPD-NRF(RE)FP-192, p. 8; WAPD-NRF(L)C-58 (for module B III-2 only)

d. WAPD-NRF(RE)FP-192, p. 8; WAPD-NRF(L)C-58 (for module B III-2 only)

e. Plus one flux thimble

f. Base plate number

g. WAPD-NRF(L)C-93

h. WAPD-NRF(L)C-104

i. WAPD-NRF(L)C-117

j. WAPD-NRF(L)C-123

k. Some of the rods in the Type C liners are unirradiated.

Table 6-2. Number and type of fuel rods in each liner.

Module Type	Liner No.							Total
	15681 ^a	15682 ^a	15683 ^b	15684 ^c	15685 ^b	15686 ^b	15687 ^d	
SI-1						42		42
SII-3						128		128
SIII-1						43		43
SIII-2						39		39
BI-3		31			6		8	45
BII-2		7		39	23		11	80
BIII-2		91		91	180		29	391
BIII-6		46		14	4		14	78
RIV-3	27		3					30
RIV-4	37		39					76
RIV-9	56		1					57
RV-4	7		30					37
Unirradiated rods	0	0	7	0	30	18	0	55
Total number rods	127	175	80	144	243	270	62	1,101

a. Reference: Letter WAPD-NRF(L)-C-93.

b. Reference: Letter WAPD-NRF(L)-149.

c. Reference: Letter WAPD-NRF(L)C-104.

d. Reference: Letter WAPD-NRF(L)-123.

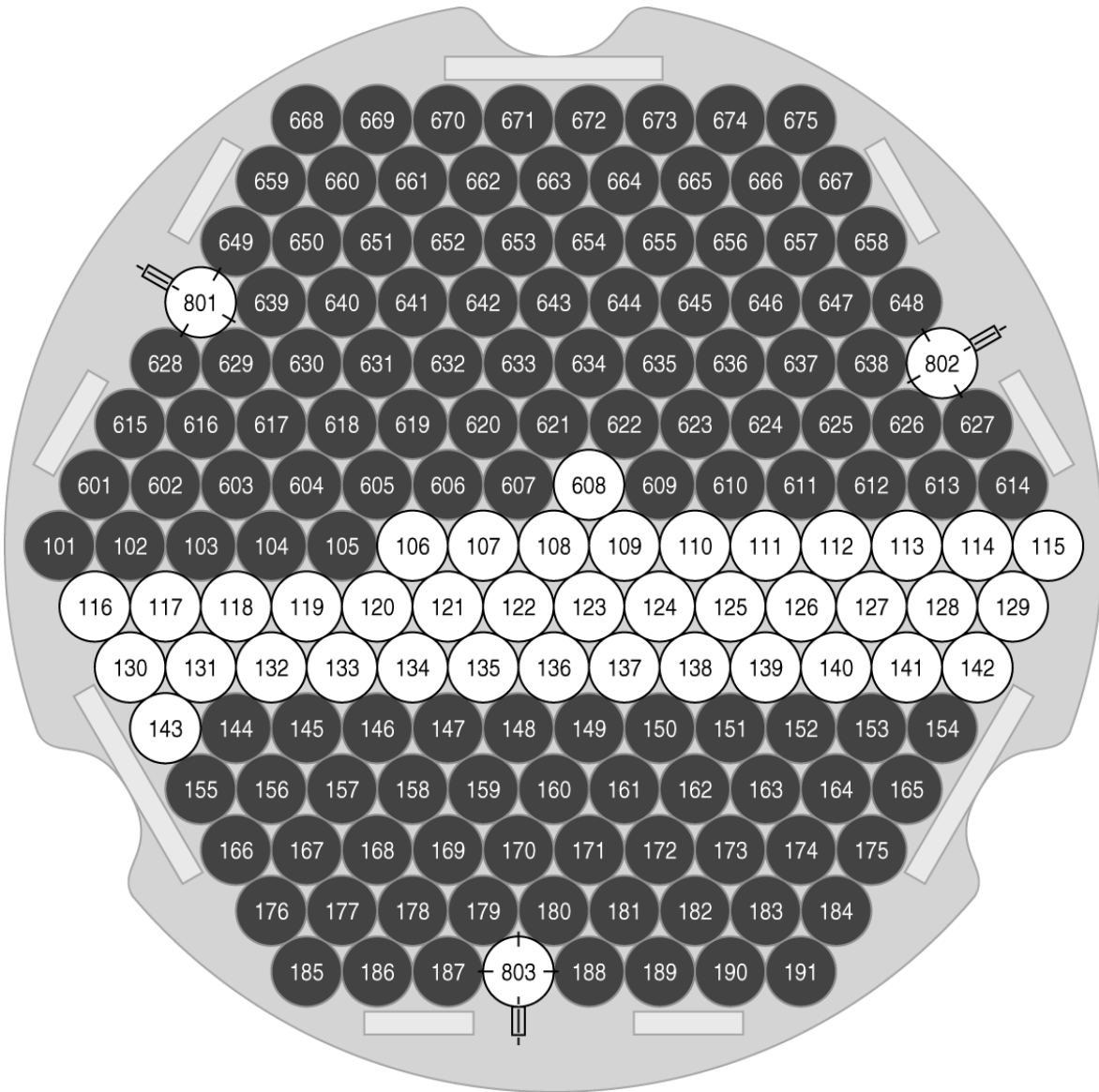

Figure 6-17. Occupied liner cells (in black) for reflector rod storage Liner 15681 (see attachment to letter WAPD-NRC(L) C-93).

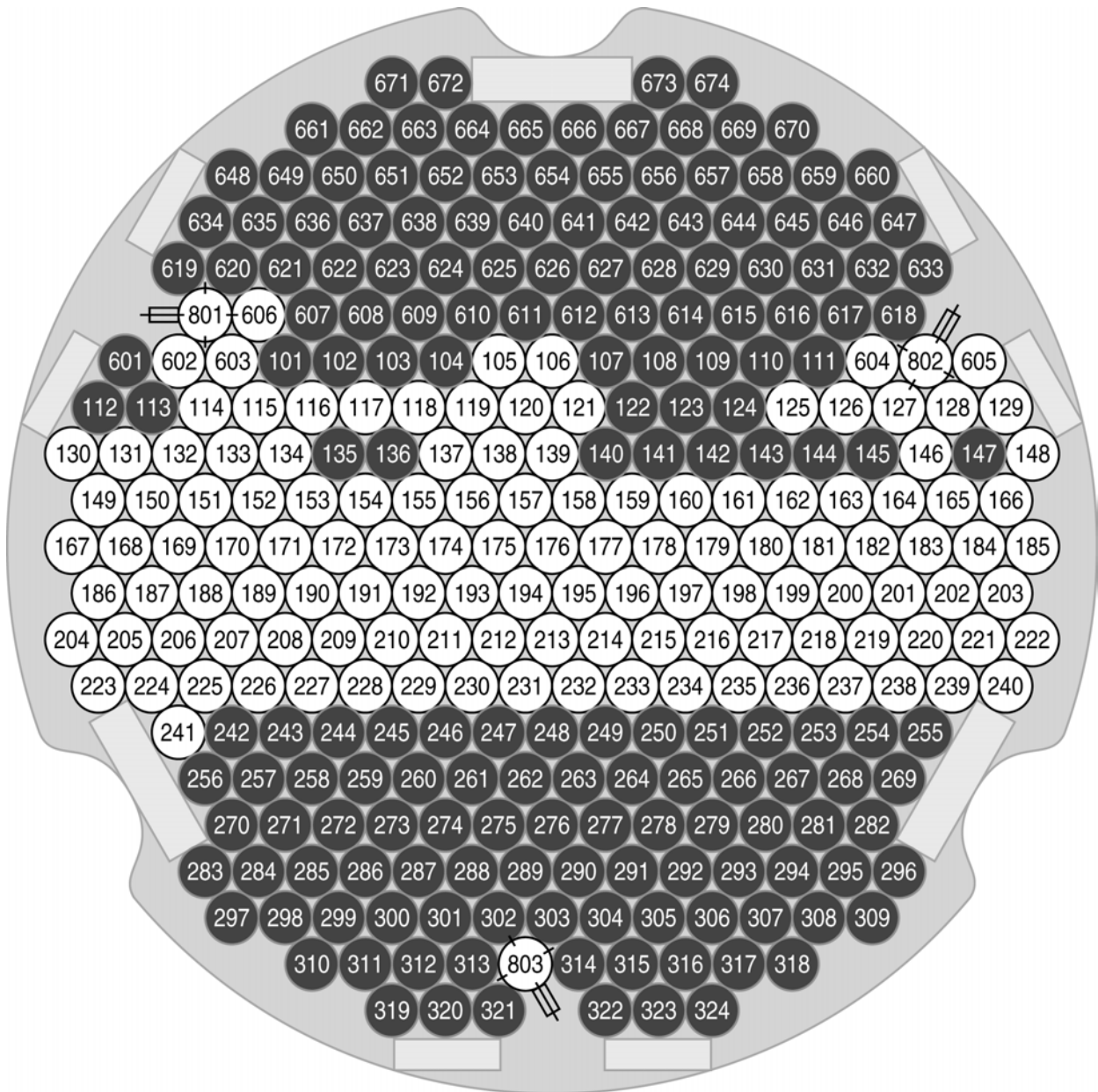

Figure 6-18. Occupied liner cells (in black) for blanket rod storage Liner 15682 (see attachment to letter WAPD-NRC(L) C-93).

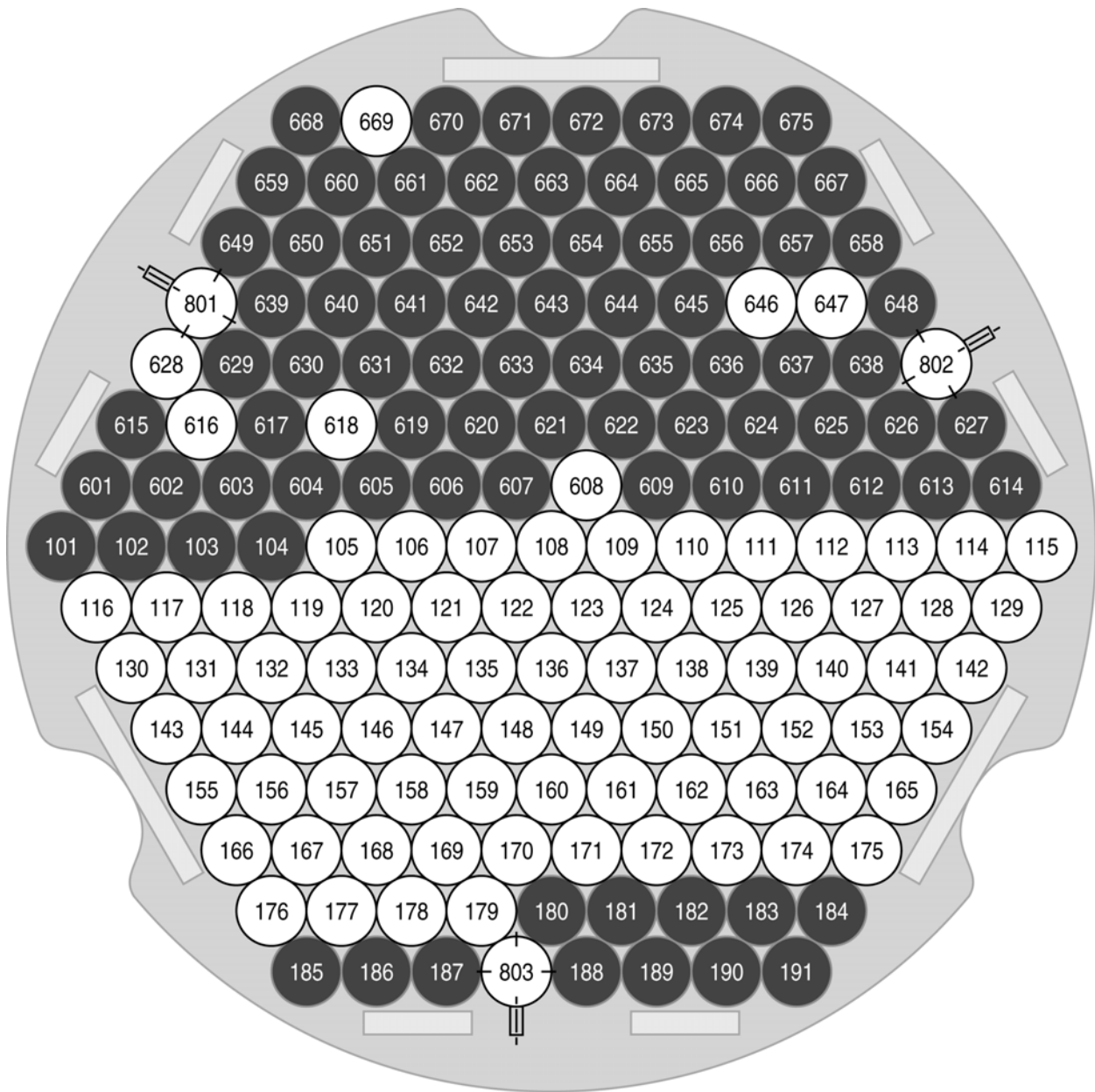

Figure 6-19. Occupied liner cells (in black) for reflector rod storage Liner 15683 (see attachment to letter WAPD-NRC(L)104 and WAPD-NRF(L)C-149).

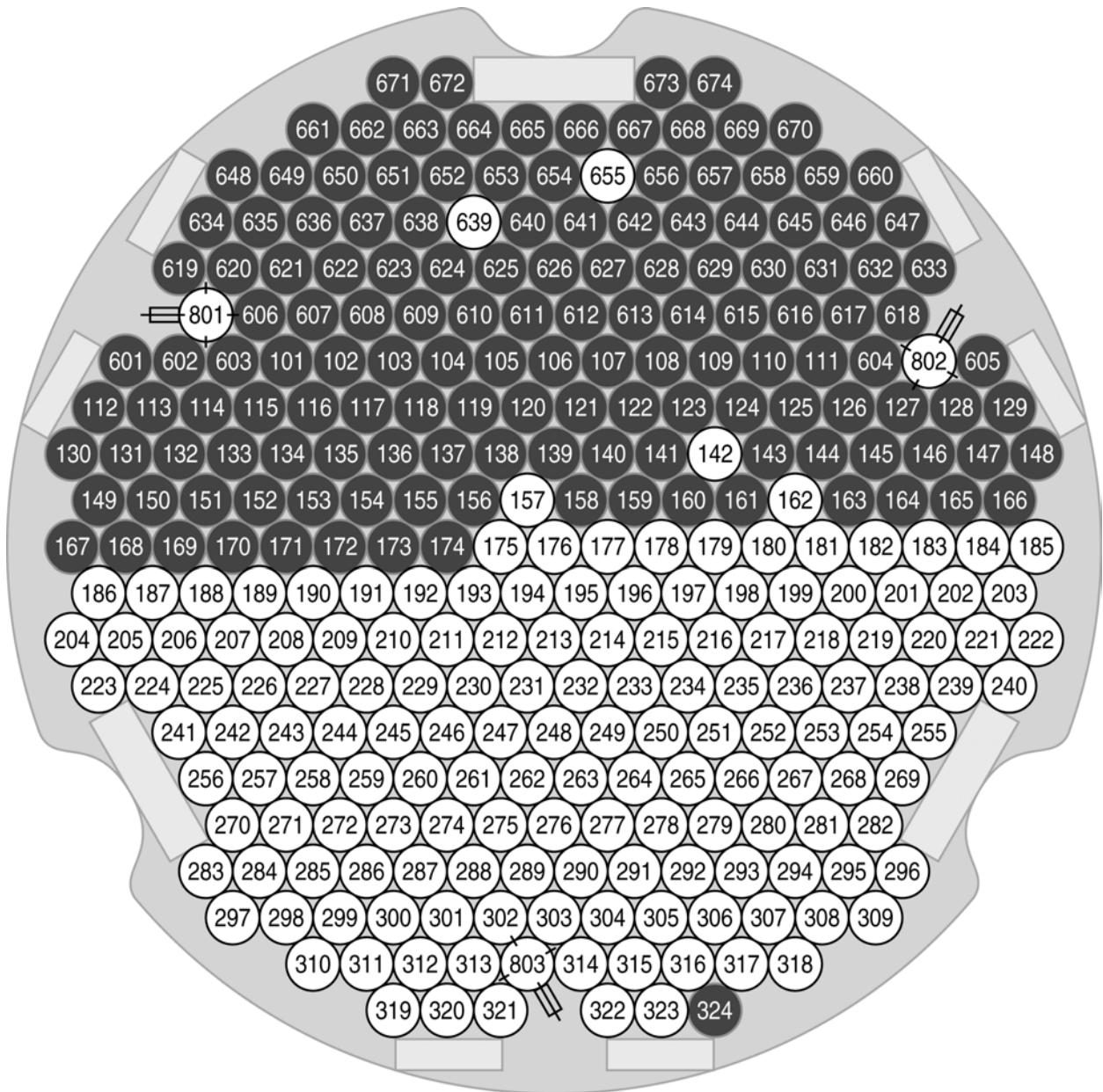

Figure 6-20. Occupied liner cells (in black) for blanket rod storage Liner 15684 (see attachment to letter WAPD-NRC(L) C-104).

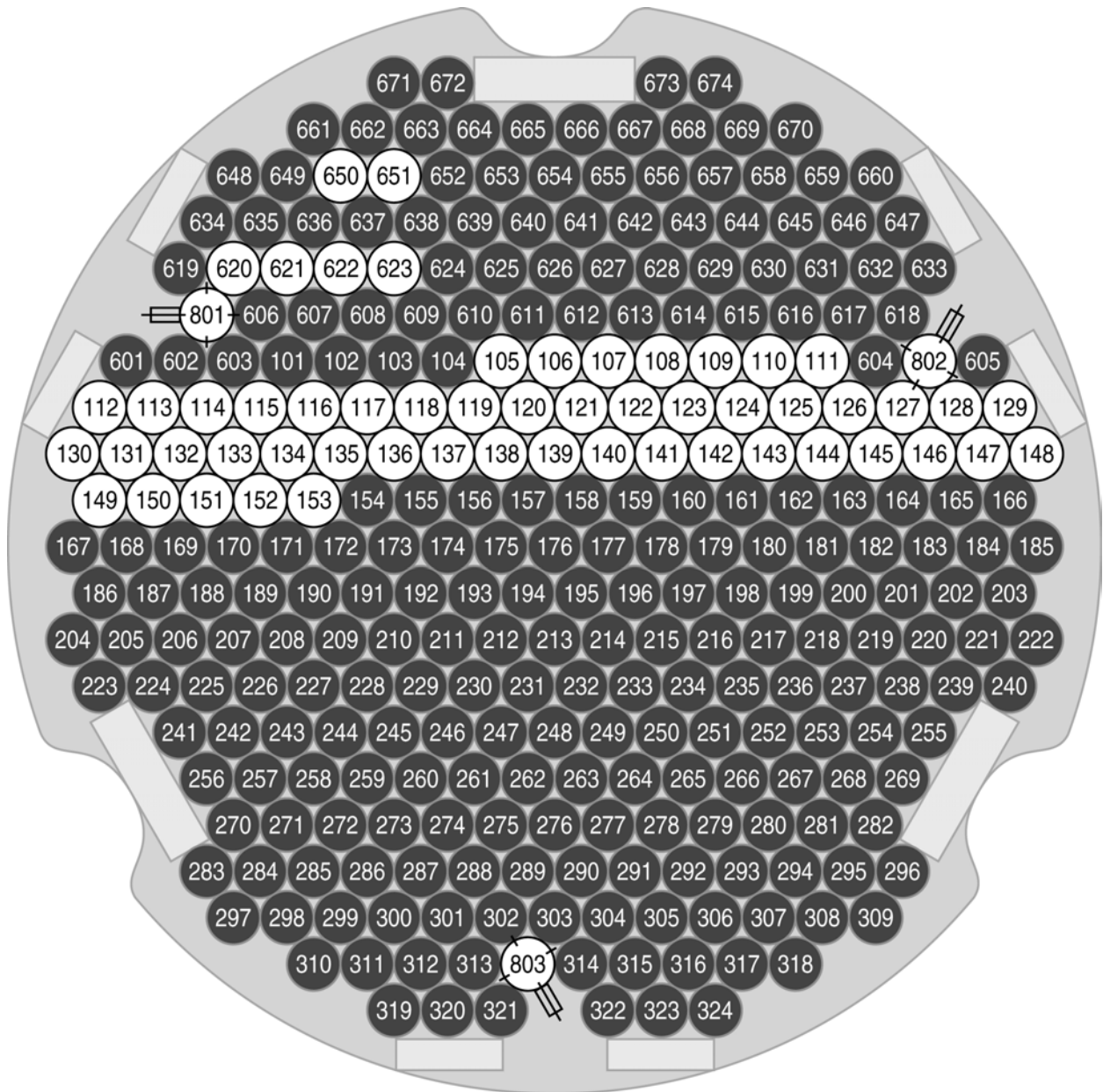

Figure 6-21. Occupied liner cells (in black) for blanket rod storage Liner 15685 (see attachment to letter WAPD-NRC(L)149).

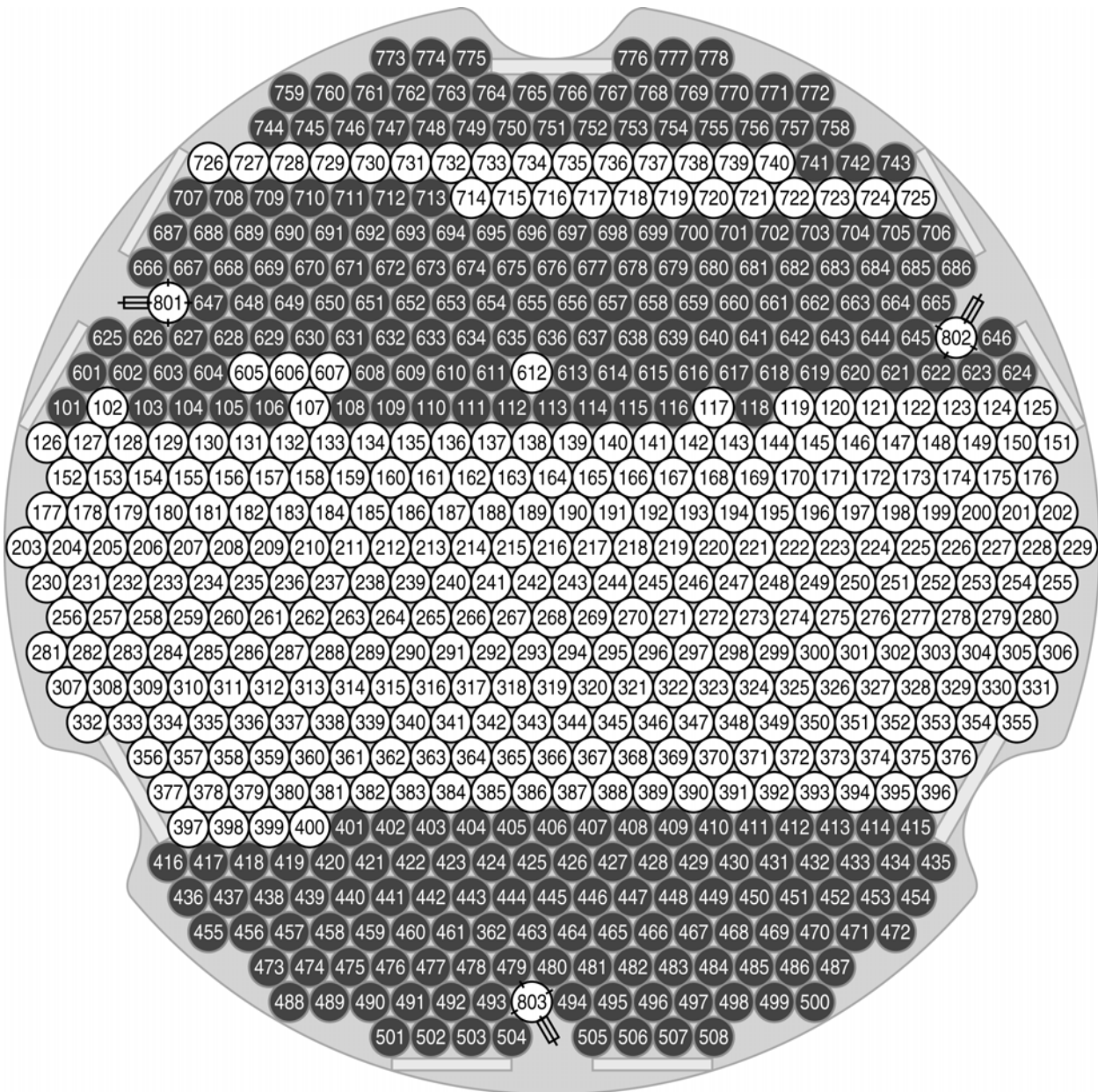
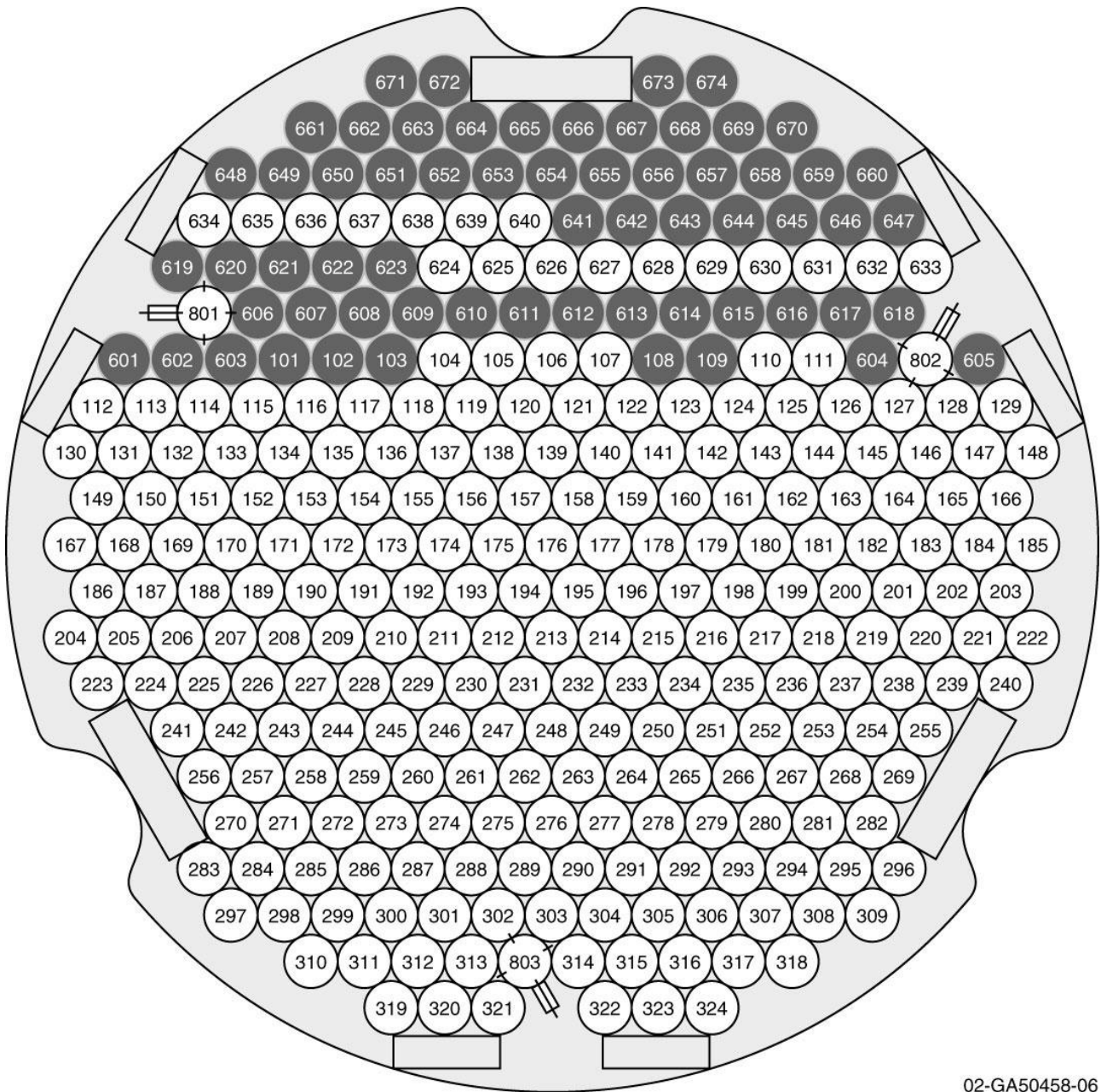

Figure 6-22. Occupied liner cells (in black) for seed rod storage Liner 15686 (see attachment to letter WAPD-NRC(L)149).



02-GA50458-06

Figure 6-23. Occupied liner cells (in black) for blanket rod storage Liner 15687 (see attachment to letter WAPD-NRC(L)123).

6.4 Condition of SNF

Fuel in Type A liners is likely intact, although there may have been some cladding breach on two Type A seed modules (see Section 6.2.2 above). The information provided in the Part B data did not indicate which seed modules contained the possible breached cladding. Part C FRC data indicated that Seeds 3-5 (Shipment 27) and 3-6 (Shipment 28) were suspect for breached cladding because radioactive gas was present when the can atmosphere was sampled. Further sampling of both of these Type A liners indicated no presence of Krypton-85, and in both cases, the conclusion was that the fuel was sealed in liner storage containers (see WAPD-NRF(L)C-117, Attachment page 3).

Type B liners contain partially derodded modules. Derodding involved sawing off the top of the core with the cutoff system described in Greenberger and Miller 1987 (WAPD-TM-1608). Type C liners contain rods that have been removed from the modules that now occupy the Type B canisters.

The cut fuel can (Liner 15718) contains fuel pieces that were part of testing during design of the LWBR fuel. The fuel pieces and rods are in various stages of disassembly and condition due to destructive and nondestructive tests on the rods. The descriptions of the tests and the rods used in the tests are provided in Appendix C. Liner 15718 contains remnants from 260 to 275 test rods, which were similar in size and composition to the LWBR fuel rods. Most of the test rods were tested under normal LWBR pressure and temperature conditions, but some operated at low system pressure and low coolant temperatures. With the exception of 2 of 271 rods described in WAPD-TM-1208, no breach of cladding integrity was observed in any test rod during normal operations; however, several rods were cut up. Intentionally severe overtest conditions resulted in two rods damaged (Conners et al. 1979, WAPD-TM-1208, p. 30).

6.5 Thermal Output

Heat output data for each of the storage liners at the time of shipping were provided in the Part C Fuel Receipt Criteria and are presented in Table 6-3, along with other data from Part C. The decay heat curves as a function of cooling time for the hottest fully rodded seed, blanket, and reflector modules (i.e., upper limit rates) were included in the Part B Fuel Receipt Criteria (e.g., WAPD-NRF(L)C-104), see Figure 6-24. The decay heat curve spans over a 10-year cooling time. Assuming a start date of December 2, 1982, the curve spans through December 2, 1992.

Sterbentz and Wahnschaffe (2001) predicted heat rate generation for a single seed (Type I), standard blanket (Type I), standard/power-flattening blanket (Type II), standard/power-flattening blanket (Type III), Reflector IV, and Reflector V module. Module heat rates are given as a function of decay date (2000–2030). These calculated module heat rates were compared to heat rates reported in WAPD-NRF(L)C-104, which were calculated values verified against actual LWBR module decay heat measurements. The calculated values from Sterbentz and Wahnschaffe (2001) were 33% and 29% higher than the WAPD Fuel Receipt Criteria values for a single seed module and a single standard/power-flattening blanket module, respectively. The Type IV Reflector decay heat value from Sterbentz and Wahnschaffe (2001) was approximately 29% lower than the WAPD value. The estimated decay heat values from Sterbentz and Wahnschaffe for year 2005 are presented in Table 6-4.

6.6 Liquid Content of Canister

While at ECF, each fuel storage liner was stored in the ECF waterpit. Prior to shipment, each liner was dried to the extent that no liquid water remained (see p. 5 of the [Part B Fuel Receipt Criteria] attachment transmitted in WAPD-NRF(L)C-104, April 30, 1987). As stated in Part B FRC (p. 7 of Attachment to WAPD-NRF(L)C-104, April 30, 1987), “Prior to shipment, the LWBR fuel storage liner

Table 6-3. Data from Part C fuel receipt criteria (by liner number).

Liner No.	Type	Container	U-233 (Ci)	Th-232 (Ci)	Total Ci (Ci)	Surface Rad (mrem/hr)	Rad at 3 ft (mrem/hr)	Mass U Before Burnup ^a (g)	Est. Mass U after Burnup ^a (g)	Fissile Before Burnup ^a (g)	Est. Fissile After Burnup ^a (g)	Decay Heat (watts)	Mass of Contents (lb)	Liner Mass (lb)	Total Mass (lb)
15601	B	S-1-1	1.46E+02	4.38E-02	4.00E+05	11.5	0.3	16785	12841	16505	11308	462.9	2013	2696	4709
15602	A	S-1-2	1.59E+02		4.00E+05	6.5	3.5	16792	14014	16507	12343	586	1654	2696	4350
15603	A	S-1-3	1.82E+03		4.00E+05	9.5	5.5	16803	14014	16523	12343	465.9	1654	2696	4350
15604	A	S-2-1	1.60E+02	4.77E-01	4.00E+05	7.2	3	16808	14243	16529	12752	414	1654	2696	4350
15605	A	S-2-2			4.00E+05	8.3	3	16808	14243	16528	12752	419.3	1654	2696	4350
15606	B	S-2-3	1.30E+02	3.77E-04	4.00E+05	5.4	1.2	16844	11530	16569	10330	448.3	2013	2696	4709
15607	B	S-3-1	1.46E+02	4.38E-02	4.00E+05	3.9	1.6	16783	13414	16505	12169	377	2013	2696	4709
15608	B	S-3-2	1.46E+02	4.38E-02	4.00E+05	3.4	1.2	16821	13460	16545	12211	377	2013	2696	4709
15609	A	S-3-3	1.50E+02		4.00E+05	4	0.2	16833	14457	16558	13118	379.6	1654	2696	4350
15610	A	S-3-4	1.59E-02		4.00E+05	5.4	2.2	16827	14457	16552	13118	480.5	1654	2696	4350
15611	A	S-3-5	1.60E+02	1.26E-01	4.00E+05	5.9	2	16836	14457	16562	13118	379.6	1654	2696	4350
15612	A	S-3-6	1.38E+02	1.26E-01	4.00E+05	4.3	0.7	16834	14457	16557	13118	374.8	1654	2696	4350
15613	A	B-1-1	1.55E+02	1.43E-01	4.00E+05	9	2.5	16834	14457	16166	19363	696.8	4212	2238	6450
15614	A	B-1-2	1.54E+02	1.43E-02	4.00E+05	14.8	4.9	16444	21579	16164	19363	889.5	4212	2238	6450
15615	B	B-1-3	1.38E+02	1.26E-01	4.00E+05	14	2.4	16439	19041	16161	17086	698	4718	2238	6956
15616	A	B-2-1	2.80E+02		4.00E+05	20.5	3.5	25377	27954	24915	25427	879	4890	2210	7100
15617	B	B-2-2	Missing	Missing	Missing	Missing	Missing	25440	23795	24969	21641	755.9	5410	2210	7620
15618	A	B-2-3	1.59E-02		4.00E+05	19	8	25384	27954	24917	25427	937.6	4890	2210	7100
15619	A	B-3-1	2.78E+02		4.00E+05	35	9	30342	31784	29776	29285	994.7	6015	3300	9315
15620	B	B-3-2	1.55E+02	1.43E-01	4.00E+05	3.6	2	30328	11999	29754	11075	732.2	5809	2647	8456
15621	A	B-3-3	1.55E+02	1.43E-01	4.00E+05	13	3.1	30404	31844	29831	29343	740.8	5303	2647	7950
15622	A	B-3-4	2.88E+02		4.00E+05	8.5	2.6	30395	31844	29821	29343	890	5303	2647	7950
15623	A	B-3-5	2.78E+02		4.00E+05	25	8	30400	31840	29860	29620	Missing	Missing	Missing	Missing
15624	B	B-3-6	1.38E+02	1.26E-01	4.00E+05	7	1.8	30409	27525	29830	25360	744	5809	2647	8456
15625	A	R-4-1		1.10E-01	4.00E+05	2.7	1	0	2975	0	2908	Missing	Missing	Missing	Missing
15626	A	R-4-2		1.10E-01	4.00E+05	3.4	0.32	0	2975	0	2902	28.36	4933	2667	7600
15627	B	R-4-3		1.31E-01	4.00E+05	0.7	0.02	0	2413	0	2361	21.7	4933	2667	7600
15628	B	R-4-4		1.31E-01	4.00E+05	0.6	0.3	0	1596	0	1569	21.1	5200	2667	7867

Table 6-3. (continued).

Liner No.	Type	Container	U-233 (Ci)	Th-232 (Ci)	Total Ci (Ci)	Surface Rad (mrem/hr)	Rad at 3 ft (mrem/hr)	Mass U Before Burnup ^a (g)	Est. Mass U after Burnup ^a (g)	Fissile Before Burnup ^a (g)	Est. Fissile After Burnup ^a (g)	Decay Heat (watts)	Mass of Contents (lb)	Liner Mass (lb)	Total Mass (lb)
15629	A	R-4-5	1.26E-01	1.26E-01	4.00E+05	1.35	0.25	0	3255	0	3175	25.3	4933	2667	7600
15630	A	R-4-6	1.43E-02	1.43E-02	4.20E+05	1.15	0.25	0	3255	0	3175	29.3	4933	2667	7600
15631	A	R-4-7	1.43E-02	1.43E-02	4.00E+05	0.8	0.3	0	3246	0	3167	27	4933	2667	7600
15632	A	R-4-8	1.43E-02	1.43E-02	4.00E+05	1.4	0.7	0	3255	0	3175	29	4933	2667	7600
15633	B	R-4-9	1.31E-01	1.31E-01	4.00E+05	<0.1	<0.1	0	2516	0	2454	21.4	5200	2667	7867
15634	A	R-5-1	1.10E-01	1.10E-01	4.00E+05	1.2	0.2	0	1689	0	1662	Missing	Missing	Missing	Missing
15635	A	R-5-2	1.10E-01	1.10E-01	4.00E+05	0.3	0.2	0	1689	0	1662	10.3	4028	2322	6350
15636	A	R-5-3	1.10E-01	1.10E-01	4.00E+05	0.45	0.2	0	1689	0	1662	41	4028	2322	6350
15637	B	R-5-4	1.31E-01	1.31E-01	4.00E+05	0.3	0.15	0	1255	0	1236	9.5	4204	2322	6526
15638	A	R-5-5	Missing	Missing	Missing	Missing	Missing	0	1689	0	1662	11.4	4028	2322	6350
15639	A	R-5-6	1.10E-01	1.10E-01	4.00E+05	0.5	<0.1	0	1689	0	1662	12	4028	2322	6350
15681	C	FR-R1	8.50E-02	8.50E-02	1.20E+03	0.4	0.17	0	2207	0	2144	23.44	4783	2017	6800
15682	C	FR-B1	8.50E+01	1.90E-01	2.10E+04	2.6	0.15	9040	9132	8865	8418	744.2	3435	2365	5800
15683	C	FR-R2	1.89	2.12E-01	4.00E+04	0.2	<0.1	201	1313	197	1281	73.12	2495	3505	5800
15684	C	FR-B2	6.70E+01	4.20E+01	1.27E+03	5	1.3	7092	7391	6958	6765	753	4802	2635	7167
15685	C	FR-B3	98.33	7.13E-01	2.40E+04	4.9	1.8	10530	11422	10332	10545	751.5	3985	2365	6350
15686	C	FR-S1	67.8	2.08E-01	3.00E+05	2.3	0.8	7230	6121	7109	5516	446.8	3524	2696	6220
15687	C	FR-B4	30	1.94E-01	1.23E+03	5.4	0.1	2464	2978	2421	2705	751.5	4970	2365	7335
15718	Cut fuel	4.78E+00	1.58E-03	6.24E+04	6.62	0.04	10267 ^b	Missing	10715	Missing	234	7207	1036	8243	

a. Values rounded to five significant figures

b. Inconsistent data from Bettis

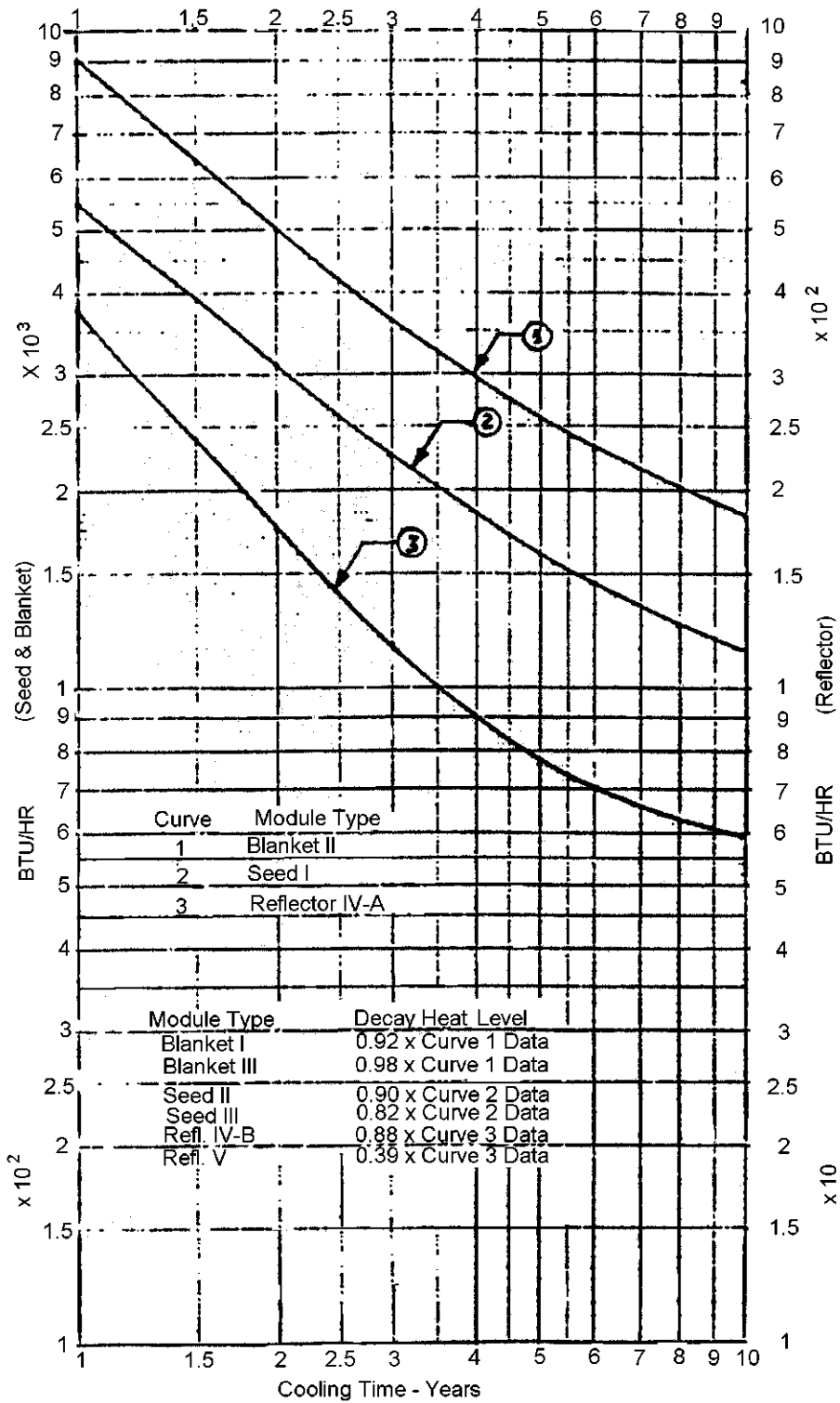

Figure 6-24. Decay heat as a function of cooling time for the hottest fully rodded seed, blanket, and reflector modules (attached to WAPD-NRF(L)C-104 [curve on p. 15, some discussion on p. 4-5], April 30, 1987, Fuel Receipt Criteria, Part B).

Table 6-4. Estimated decay heat values for Light Water Breeder Reactor core modules in the year 2005 (Sterbentz and Wahnschaffe, 2001).

Module Type	Decay Heat (Watts)
Single seed (Type I)	352.8
Standard blanket (Type I)	501.5
Standard/power flattening blanket (Type II)	517.1
Standard/power flattening blanket (Type III)	480.5
Reflector IV	9.62
Reflector V	4.7

must be internally dry and contain an inert atmosphere. A liner is defined as dry when all liquid water has been removed. The drying process was confirmed by checkout and testing of the LWBR Liner Closure Station dewatering equipment used on an actual fuel storage liner both at a vendor shop and at ECF. ECF will certify that the liner for each fuel handling unit is dry and contains the inert atmosphere as required.” Pressure testing (hydrostatic test, neon and helium gas tests, and a hydraulic jack test) was conducted prior to shipment, and the completed certification checklists for each shipment, including shift supervisor and engineering checkoffs for “no liquid water in liner” are included in the Part C Fuel Receipt Criteria.

7. REFERENCES

- Atherton, R. (coordinator), 1987, Water Cooled Breeder Program Summary Report (LWBR Development Program), WAPD-TM-1600, October 1987.
- Beaudoin, B. R., 1987, *Loading Assurance Methods Used in the Manufacture of the Light Water Breeder Reactor (LWBR)*, WAPD-TM-1315, September 1987.
- Budd, W. A. (ed.), 1986, *Shippingport Operations With the LWBR Core (LWBR Development Program)*, WAPD-TM-1542, March 1986.
- Campbell, W. R., and J. F. Giovengo, 1987, *Light Water Breeder Reactor Fuel Rod Design and Performance Characteristics (LWBR Development Program)*, WAPD-TM-1387, October 1987.
- Cole, L. N., 2001, *Shippingport LWBR Spent Nuclear Fuel Data for Transfer from CPP-749 to Spent Nuclear Fuel Dry Storage Project*, EDF-2875.
- Connors, D. R., S. Milani, J. A. Fest, and R. Atherton, 1979, *Design of the Shippingport Light Water Breeder Reactor*, WAPD-TM-1208, January 1979.
- DeGeorge, V. V., and I. Goldberg, eds., 1986, *The Fabrication and Loading of Fuel Rods for the Light Water Breeder Reactor (LWBR Development Program)*, WAPD-TM-1278, March 1986.
- Eyler, J. H., 1981, *Development and Control of the Process for the Manufacture of Zircaloy-4 Tubing for LWBR Fuel Rods (LWBR Development Program)*, WAPD-TM-1289, January 1981.
- Freeman, L. B. (ed.), 1978, *The Calculational Model Used in the Analysis of Nuclear performance of the Light Water Breeder Reactor (LWBR)*, WAPD-TM-1314, August 1978.
- Fuel Receipt Criteria, Part A, sent from Westinghouse Electric Corporation LWBR Fuel Disassembly and Disposal Engineering, NRF Project to ECF LWBR Engineering at Naval Reactors Facility:
- WAPD-NRF(L)D-96, August 10, 1987
- WAPD-NRF(L)D-58, March 13, 1987
- WAPD-NRF(L)D-5, September 22, 1986
- WAPD-NRF(E)FD-09, Received March, 1985
- WAPD-LP(CE)FD-38, October 12, 1984
- Fuel Receipt Criteria, Part B sent from Westinghouse Electric Corporation to CPP-666 (listed alphabetically by letter number):
- NRFE-LWBRE-1034, October 28, 1986
- RDD-94-86 (transmittal letter from R.D. Denney, INEL, to R. E. Wilson, Manager, INEL Criticality Safety), transmitting WAPD-NRF(RE)FP-192, May 27, 1986
- WAPD-NRF(E)-9, February 13, 1985

WAPD-NRF(L)-149, September 15, 1987

WAPD-NRF(L)C-104, April 30, 1987

WAPD-NRF(L)C-117, June 26, 1987

WAPD-NRF(L)C-123, July 8, 1987

WAPD-NRF(L)C-58, January 9, 1987

WAPD-NRF(L)C-93, March 26, 1987

WAPD-NRF(L)D-110, September 23, 1987

WAPD-NRF(RE)FP-132, December 6, 1985

WAPD-NRF(RE)FP-139, December 27, 1985

WAPD-NRF(RE)FP-192, May 27, 1986

Fuel Receipt Criteria, Part C (arranged by canister):

NRFE-LWBRE-863-21, August 29, 1986 and Shipment #21 (S-1-1) September 2, 1986

NRFE-LWBRE-863-12, April 17, 1986 and Shipment #14 (S-1-2), April 25, 1986

Shipment #15 (S-1-3), June 5, 1986

Shipment #38 (S-2-1), April 20, 1987

Shipment #16 [S-II-1 (sic)], June 12, 1986

Shipment #44 (S-2-3), July 31, 1987

Shipment #22 [S-III-I (sic)], September 12, 1986

Shipment #23 [S-III-2 (sic)], September 29, 1986

Shipment #17 (S-3-3), June 27, 1986

Shipment # not identified (S-3-4), May 2, 1986

Shipment #27 (S-3-5), November 24, 1986

Shipment #28 (S-3-6), December 23, 1986

Shipment #30 [B1-1 (sic)], January 29, 1987

Shipment #8 (B-1-2), March 19, 1986

Shipment #25 (B-1-3), November 3, 1986

- Shipment #20 (B-2-1), August 25, 1986
- Shipment #32 (B-2-2), March 9, 1987
- Shipment #14 (B-2-3), May 28, 1986
- Shipment #1 [B31 (sic)], December 12, 1985
- Shipment #36 (B-3-2), April 2, 1987
- Shipment #31 [B3-3 (sic)], February 5, 1987
- Shipment #19 (B-3-4), August 8, 1986
- Shipment #2 (B-3-5), December 12, 1985
- Shipment #26 (B-3-6), November 14, 1986
- Gorscak, D. A., W. R. Campbell, and J. C. Clayton, 1987, *End-Of-Life Nondestructive Examination of Light Water Breeder Reactor Fuel Rods (LWBR Development Program)*, WAPD-TM-1605, October 1987.
- Graczyk, D. G., J. C. Hoh, F. J. Martino, R. E. Nelson, J. Osudar, and N. M. Levitz, 1987, *Final Report for the Light Water Breeder Reactor Proof-of-Breeding Analytical Support Project*, ANL-87-2.
- Greenberger, R. J., and E. L. Miller, 1987, *Primary Disassembly of LWBR Modules for Core Evaluation (LWBR Development Program)*, WAPD-TM-1608, October 1987.
- Hecker, H. C., 1979, *Summary of the Nuclear Design and Performance of the Light Water Breeder Reactor (LWBR)*, WAPD-TM-1326, June 1979.
- Hecker, H. C., and L. B. Freeman, 1981, *Design Features of the Light Water Breeder Reactor Which Improve Fuel Utilization in LWRs (LWBR Development Program)*, WAPD-TM-1409, August 1981.
- Hodges, B. W. (ed.), 1987, *Preparation of LWBR Spent Fuel for Shipment to ICPP for Long Term Storage (LWBR Development Program)*, WAPD-TM-1601, October 1987.
- Idaho Nuclear Technology and Engineering Center (INTEC) Plant Safety Document, Section 4.7A, 2002, *Storage of Unirradiated and Irradiated Light Water Breeder Reactor Fuel in Underground Dry Wells at INTEC*, Rev. 3, July 17, 2002.
- Massimino, R. J., and D. A. Williams, 1983, *The Installation of the Light Water Breeder Reactor at the Shippingport Atomic Power Station (LWBR Development Program)*, WAPD-TM-1342, May 1983.
- Richardson, K. D., W. R. Campbell, J. C. Clayton, and B. C. Smith, 1987, *End of Life Destructive Examination of Light Water Breeder Reactor Fuel Rods*, WAPD-TM-1606, October 1987.
- Sarber, W. K., 1983, *Reactor Physics Test Program for the Light Water Breeder Reactor (LWBR) Core at Shippingport (LWBR Development Program)*, WAPD-TM-1455, Addendum, December 1983.

- Sarber, W. K., ed., 1976, *Results of the Initial Nuclear Tests on the LWBR (LWBR Development Program)*, WAPD-TM-1336, June 1976.
- Schick, W. C., Jr., B. R. Beaudoin, W. J. Beggs, L. B. Freeman, and G. Tessler, 1987, *Proof of Breeding in the Light Water Breeder Reactor (LWBR Development Program)*, WAPD-TM-1612, September 1987.
- Selsley, I. A., ed., 1987a, *Defueling of the Light Water Breeder Reactor at the Shippingport Atomic Power Station*, WAPD-TM-1551, September 1987.
- Selsley, I. A., 1987b, *Shipment of the Light Water Breeder Reactor Fuel Assemblies from the Shippingport Atomic Power Station to the Expended Core Facility (Idaho)(LWBR Development Program)*, WAPD-TM-1553, October 1987.
- Selsley, I. A. (ed.), 1987c, *Light Water Breeder Reactor Fuel Module Disassembly at the Shippingport Atomic Power Station (LWBR Development Program)*, WAPD-TM-1552, October 1987.
- Sterbentz, J. W., 1999, *Validation Work to Support the Idaho National Engineering and Environmental Laboratory Computational Burnup Methodology Using Shippingport Light Water Vreeder Reactor (LWBR) Spent Fuel Assay Data*, INEEL/EXT-99-00581, August 1999.
- Sterbentz and Wahnschaffe (2001). Light Water Breeder Reactor (LWBR) Decay Heat Estimate Analysis. EDF 1781, rev. 1.
- Tessler, G., B. R. Beaudoin, W. J. Beggs, L. B. Freeman, and W. C. Schick, 1987, *Nondestructive Assay of Spent Fuel Rods From the LWBR (LWBR Development Program)*, WAPD-TM-1614, September 1987.
- Walter, J. F., and W. A. Weinreich, eds., 1976, *ThO₂ and ThO₂-²³³UO₂ High Density Fuel Pellet Manufacture for the Light Water Breeder Reactor*, WAPD-TM-1244(L), January 1976.
- Wargo, J. E., 1987, *Light Water Breeder Reactor End-of-Life Component Examinations at Shippingport Atomic Power Station and Module Visual and Dimensional Examinations at Expended Core Facility*, WAPD-TM-1602, October 1987.
- Williams, J. T., 1987, *Light Water Breeder Reactor Core Evaluation Operations at the Expended Core Facility*, WAPD-TM-1611, October 1987.

Other References

- Bacvinskas, W. S. (ed.), 1987, *Light Water Breeder Reactor Module and Rod Examinations LWBR Development Program*, WAPD-TM-1610, October 1987.
- Beaudoin, B. R., W. J. Beggs, C. R. Case, and R. Wilczynski, 1979, *A System of Datatran Modules Which Process Core Fuel Loading for Use in As-Built Calculations (LWBR Development Program)*, WAPD-TM-1316, February 1979.
- Benton, Hugh, et al., 1997, *Technical Strategy for the Management of Spent Nuclear Fuel*, March 1997.
- Berman, R. M., H. B. Meieran, and P. W. Patterson, 1967, *Irradiation Behavior of Zircaloy-Clad Fuel Rods Containing Dished-End UO_2 Pellets (LWB-LSBR Development Program)*, WAPD-TM-629, July 1967.
- Bolton, S. R., et al., ICPP Final Safety Analysis (Section 4.7) "Storage of Unirradiated and Irradiated Light Water Breeder Reactor Fuel in Underground Dry Wells at ICPP," WIN-107-4.7A-Rev. 1, March 1989.
- Busby, C. C., and K. B. Marsh, 1970, *High Temperature Deformation and Burst Characteristics of Recrystallized Zircaloy-4 Tubing (LWBR Development Program)*, WAPD-TM-900, January 1970.
- Caffarel, A. J., 1979, *The Inspection of Assembled LWBR Fuel Rods for Internal Dimensions and Pellet Integrity Utilizing In-Motion Radiography (LWBR Development Program)*, WAPD-TM-1239, February 1979.
- Clayton, J. C., 1982, *Corrosion and Hydriding of Irradiated Zircaloy Fuel Rod Cladding (LWBR Development Program)*, WAPD-TM-1440, September 1982.
- Clayton, J. C., 1985, *Cladding Corrosion and Hydriding in Irradiated Defected Zircaloy Fuel Rods (LWBR Development Program)*, WAPD-TM-1393, August 1985.
- Clayton, J. C., 1987, *In-Pile and Out-of-Pile Corrosion Behavior of Thoria-Urania Pellets (LWBR Development Program)*, WAPD-TM-1548, January 1987.
- Daniel, R. C., 1971, *In-Pile Dimensional Changes of Zircaloy-4 Tubing Having Low Hoop Stresses (LWBR Development Program)*, WAPD-TM-973, July 1971.
- Duncombe, E., 1968, *Analysis of Void Migration, Clad Collapse and Fuel Cracking in Bulk Oxide Fuel Rods (LWBR Development Program)*, WAPD-TM-794, July 1968.
- Duncombe, E., and I. Goldberg, 1970, *Comparison of Dimensional Changes in Fuel Rods With Predictions Under Cyclic Conditions of Power and System Pressure (LWBR Development Program)*, WAPD-TM-940, March 1970.
- Duncombe, E., et al., *Comparisons With Experiment of Calculated Dimensional Changes and Failure Analysis of Irradiated Bulk Oxide Fuel Test Rods Using the CYGRO-1 Computer Program*, September 1966.
- Emert, C. J., 1979, *The Nondestructive Assay of UO_2 - ThO_2 Fuel Pellets Using the Delayed Neutron Pellet Assay Gauge (LWBR Development Program)*, WAPD-TM-1368, June 1979.

- Engel, J. T., and H. B. Meieran, 1968, *Performance of Fuel Rods Having 97 Percent Theoretical Density UO₂ Pellets Sheathed in Zircaloy-4 and Irradiated at Low Thermal Ratings (LSBR/LWBR Development Program)*, WAPD-TM-631, July 1968.
- Eyler, J. H., 1979, *The Characteristics of the Zircaloy-4 Tubing in LWBR Fuel Rods (LWBR Development Program)*, WAPD-TM-869, November 1979.
- Eyler, J. H., 1981, *Development and Control of the Process for the Manufacture of Zircaloy-4 Tubing for LWBR Fuel Rods*, WAPD-TM-1289, January 1981.
- Fodor, G., 1987, *Light Water Breeder Reactor Rod Removal System (LWBR Development Program)*, WAPD-TM-1609, October 1987.
- Galtz, C. S., 1983, *The Friction Grip Enclosure—A Means for Increasing the Fatigue Life of Fuel Rod End Welds (LWBR Development Program)*, WAPD-TM-1348, March 1983.
- Giovengo, J. F., 1970, *In-Pile Dimensional Changes of ThO₂-UO₂ With Non-Free-Standing Cladding (LWBR Development Program)*, WAPD-TM-986, November 1970.
- Giovengo, J. F., I. Goldberg, and G. L. Spahr, 1982, *Fission Gas Release From High Burnup ThO₂ and ThO₂-UO₂ Fuels Irradiated at Low Temperature (LWBR/AWBA Development Program)*, WAPD-TM-1350, Addendum 2, May 1982.
- Goldberg, I., L. A. Walman, J. F. Giovengo, and W. R. Campbell, 1979, *Fission Gas Release and Grain Growth in ThO₂-UO₂ Fuel Irradiated at High Temperature (LWBR Development Program)*, WAPD-TM-1350, Addendum, July 1979.
- Gourley, B. R. (ed.), 1981, *Fabrication of Seed, Blanket and Reflector Fuel Assemblies for the Light Water Breeder Reactor (LWBR Development Program)*, WAPD-TM-1317, May 1981.
- Green, S. J., et al., 1969, *Critical Heat Flux Tests on a Coolant Channel Simulating a Closely Spaced Lattice of Rods (LWBR Development Program)*, WAPD-TM-466, March 1969.
- Hecker, H. C., 1984, *Nuclear Analysis and Performance of the Light Water Breeder Reactor (LWBR) Core Power Operation at Shippingport (LWBR Development Program)*, WAPD-TM-1376, April 1984.
- Hecker, H. C., and C. J. Simon, 1984, Idaho Chemical Processing Plant Part A Fuel Receipt Criteria for the LWBR Core, WAPD-LP(CE)FD-38 attachment, October 1984.
- Hecker, H. C., and C. J. Simon, 1985, ICPP Fuel Receipt Criteria (Part A) for the LWBR Core (Rev. 3), WAPD-NRF(E)FD-09 attachment, January 1985.
- Hersey, B. A., and H. B. Meieran, 1969, *Behavior of an Intentionally Defected Fuel Rod Which Ruptured During Irradiation (Rod BETT 79-64D) (LWBR Development Program)*, WAPD-TM-628, July 1969.
- Hoffman, R. C., and J. Sherman, 1978, *Irradiation Testing of Internally Pressurized and/or Graphite Coated Zircaloy-4 Clad Fuel Rods in the NRX Reactor (LWBR Development Program)*, WAPD-TM-1421, November 1978.

- Hoffman, R. C., J. F. Yerman, and T. H. Alff, 1982, *Experimental Results of the Irradiation of Long Rod Duplex Pellet Screening Tests in the NRX Reactor (NLDR-1 Test) (AWBA Development Program)*, WAPD-TM-1492, July 1982.
- I. Goldberg, I., C. L. Spahr, L. S. White, L. A. Waldman, J. F. Giovengo, P. L. Pfenningwerth, and J. Sherman, 1978, *Fission Gas Release From ThO₂ and ThO₂-UO₂ Fuels (LWBR Development Program)*, WAPD-TM-1350, August 1978.
- Ivak, D. M., and L. A. Waldman, 1979, *Iodine and Cesium in Oxide Fuel Pellets and Zircaloy-4 Cladding of Irradiated Fuel Rods (LWBR Development Program)*, WAPD-TM-1394, March 1979.
- Jacobs, D. C., 1969, *The In-Pile Thermoconductivity of Selected ThO₂-UO₂ Fuels at Low Depletions (LWBR Development Program)*, WAPD-TM-758, May 1969.
- Jacobs, D. C., 1970, *In-Pile and Unirradiated Thermal Conductivity of a Single-Fired ThO₂ + 10 w/o UO₂ (LWBR Development Program)*, WAPD-TM-901, February 1970.
- Kass, S., 1968, *Effects of Pressure Upon the Corrosion of Zircaloy-4 (LWBR Development Program)*, WAPD-TM-782, October 1968.
- Kass, S., 1970, *The Influence of Prior Corrosion History Upon the Hydrogen Pickup by Zircaloy During Subsequent Exposure in Hot Water (LWBR Development Program)*, WAPD-TM-906, December 1970.
- Kotula, J., 1979, *LWBR Automated Fuel Rod Loading Verification Gage System (LWBR Development Program)*, WAPD-TM-1226, February 1979.
- Markowitz, J. M., and J. C. Clayton, 1970, *Corrosion of Oxide Nuclear Fuels in High Temperature Water (LWBR Development Program)*, WAPD-TM-909, February 1970.
- McCauley, J. E., 1969, *Observations on the Irradiation Behavior of a Zircaloy-4 Clad Rod Containing Low Density ThO₂-5.3 w/o UO₂ Pellets (LWBR Development Program)*, WAPD-TM-664, December 1969.
- Meieran, H. B., W. F. Bourgeois, and J. T. Engel, 1968, *Short Term Irradiation of Zircaloy-4 Clad Fuel Rods Containing Low Density or Annular ZrO₂-UO₂ Ceramic Fuel Pellets: X-1-t Test (LWBR-LSBR Development Program)*, WAPD-TM-630, June 1968.
- Milani, S. and S. H. Weiss, 1967, *Small Uranium-233 Fueled Seed-and-Blanket Critical Experiments (LWBR-LSBR Development Program)*, WAPD-TM-614, November 1967.
- Mitchell, J. A. (ed.), 1975, *BMU Series of ²³³U Fueled Critical Experiments (LWBR Development Program)*, WAPD-TM-1117, January 1975.
- Smith, B. C. (ed.), 1987, *End-of-Life Examinations of Light Water Breeder Reactor Grids and Other Module Structural Components (LWBR Development Program)*, WAPD-TM-1607, October 1987.
- Smith, B. C., and W. R. Campbell, 1987, *Light Water Breeder Reactor Fuel Element Performance Characteristics for Extending Core Lifetime (LWBR Development Program)*, WAPD-TM-1603, October 1987.

- Smithnosky, A. J., 1982, *In-Reactor Tests of Externally Pressurized, Short, Unsupported Lengths of Zircaloy Tubing (AWBA Development Program)*, WAPD-TM-1529, October 1982.
- Sphar, C. D., and J. Sherman, 1979, *Early-In-Life Performance of Short Rod Duplex Pellet Screening (D-1) Test (AWBA Development Program)*, WAPD-TM-1378, November 1979.
- Sphar, C. D., D. A. Mertz, W. S. Roesener, 1982, *Irradiation Performance of Duplex Fuel Pellet Test Rods Depleted to 9×10^{20} Fissions/cm³ of Compartment - D-1 Test (AWBA Development Program)*, WAPD-TM-1460, January 1982.
- Springer, J. R., et al., 1967, *Fabrication, Characterization, and Thermal-Property Measurements of ThO₂-UO₂ Fuel Materials (LWBR Development Program)*, BMI-X-1020, October 1967.
- Stackhouse, R. M. (ed.), 1979, *Fuel Rod Grid Interaction Wear: In-Reactor Tests (LWBR Development Program)*, WAPD-TM-1347, November 1979.
- Stooksberry, R. W., 1979, *Conceptual Evaluation of Nondestructive Assay of ²³³UO₂-ThO₂ Fuel Rods (LWBR Development Program)*, WAPD-TM-1256, January 1979.
- Technical Specifications/Standards: 4.7B4 “Integrity of Storage Canisters and Canister Lifting Tools for Dry Well Storage of LWBR Fuels”; 4.7B6 “Spare Dry Well Requirement for LWBR Fuel Storage”; 4.7B7 “Handling of LWBR Fuel Storage Canisters—Peach Bottom Transfer Cask”; 4.7C2 “Surveillance of the LWBR Fuel Storage Dry Wells.”
- Waldman, L. A., C. D. Sphar, and T. H. Alff, 1982, *Irradiation Performance of Long Rod Duplex Fuel Pellet Bundle Test -LDR Test (LWBR Development Program)*, WAPD-TM-1481, April 1982.
- Wargo, J. E., and K. D. Richardson, 1987, *Light Water Breeder Reactor End-Of-Life Component Examinations at Shippingport Atomic Power Station and Module Visual and Dimensional Examinations at the Expanded Core Facility (LWBR Development Program)*, WAPD-TM-1602, October 1987.

Appendix A

End-of-Life Fissile Data from the Production Irradiated Fuel Assay Gauge (PIFAG)

Appendix A

End-of-Life Fissile Data from the Production Irradiated Fuel Assay Gauge (PIFAG)

The following tables were copied from Tessler et al. 1987, WAPD-TM-1614, for convenience. The pages have not been altered, and retain the table numbers inherent from the original report. Rod numbers correspond to the rod types noted in Figures 3-2, 3-3, 3-6, 3-7, 3-9 and 3-10 in INEEL-EXT-98-00799, *Fuel Summary Report: Shippingport Light Water Breeder Reactor*.

Table 26

Seed Module I-1 Fissile Fuel Loadings in Grams

Rod No.	As-Built Loading	PIFAG Thermal			PIFAG Epithermal			Epithermal - Thermal Percent Difference
		Loading	Standard Deviation		Loading	Standard Deviation		
			Grams	%		Grams	%	
0502228	34.668	25.682	0.075	0.29	25.712	0.095	0.37	+0.11
0507057	34.682	25.598	0.071	0.28	25.665	0.045	0.18	+0.26
0603327	34.551	25.481	0.072	0.28	25.372	0.065	0.26	-0.43
0605269	34.494	25.224	0.073	0.29	25.245	0.070	0.28	+0.08
0603464	34.566	25.202	0.075	0.30	25.336	0.070	0.27	+0.53
0604519	34.164	25.133	0.074	0.29	25.182	0.069	0.27	+0.19
0603289	34.440	25.353	0.074	0.29	25.317	0.064	0.25	-0.14
0501128	34.646	25.153	0.080	0.32	25.296	0.070	0.28	+0.57
0600577	34.149	24.741	0.073	0.29	24.787	0.068	0.28	+0.18
0607184	34.446	24.830	0.074	0.30	24.827	0.072	0.29	-0.01
0601504	34.222	24.837	0.072	0.29	24.813	0.069	0.28	-0.10
0501779	34.740	24.240	0.075	0.31	24.291	0.071	0.29	+0.21
0501265	34.373	24.476	0.075	0.31	24.494	0.070	0.28	+0.07
0504648	34.702	24.802	0.072	0.29	24.871	0.065	0.26	+0.28
0606681	34.248	24.069	0.080	0.33	24.141	0.072	0.30	+0.30
0608165	34.648	24.115	0.075	0.31	24.245	0.079	0.32	+0.54
0608313	34.420	23.389	0.077	0.33	23.387	0.065	0.28	-0.01
0605572	34.468	23.720	0.077	0.32	23.825	0.065	0.27	+0.44
0606378	34.407	23.883	0.087	0.36	23.902	0.069	0.29	+0.08
0606461	34.542	24.098	0.076	0.32	24.120	0.082	0.34	+0.09
0500082	34.594	23.426	0.078	0.33	23.431	0.072	0.31	+0.02
0507333	34.679	23.042	0.083	0.36	23.106	0.070	0.30	+0.28
0504042	34.604	22.949	0.078	0.34	22.964	0.050	0.22	+0.07
0507782	34.710	23.510	0.078	0.33	23.668	0.080	0.34	+0.67
0404355	23.903	17.282	0.066	0.38	17.346	0.069	0.40	+0.37
0401744	23.697	17.449	0.065	0.37	17.523	0.043	0.24	+0.42
0302578	19.055	15.498	0.061	0.39	15.556	0.069	0.45	+0.38
0307602	19.179	15.635	0.057	0.36	15.684	0.039	0.25	+0.32
0700219	14.255	14.166	0.049	0.35	14.225	0.059	0.41	+0.42
0201562	14.219	13.910	0.050	0.36	13.993	0.037	0.26	+0.60
0200343	14.347	14.219	0.048	0.34	14.231	0.062	0.44	+0.09
0211224	14.253	14.012	0.055	0.39	13.995	0.054	0.39	-0.12
0100821	14.310	13.969	0.055	0.39	13.927	0.054	0.39	-0.30

Table 27

Seed Module II-3 Fissile Fuel Loadings in Grams

Rod No.	As-Built Loading	PIFAG Thermal			PIFAG Epithermal			Epithermal - Thermal Percent Difference
		Loading	Standard Deviation		Loading	Standard Deviation		
	Grams		%	Grams		%		
0518387	34.602	26.377	0.071	0.27	26.468	0.103	0.39	+0.34
0524623	34.688	26.544	0.061	0.23	26.584	0.079	0.30	+0.15
0626528	34.694	26.357	0.069	0.26	26.514	0.087	0.33	+0.59
0626573	34.865	26.488	0.068	0.26	26.687	0.099	0.37	+0.75
0610818	34.536	26.381	0.067	0.26	26.557	0.086	0.32	+0.67
0631800	34.836	26.779	0.075	0.28	26.880	0.086	0.32	+0.38
0623860	34.871	26.545	0.068	0.26	26.555	0.087	0.33	+0.04
0615739	34.623	25.999	0.075	0.29	26.182	0.084	0.32	+0.70
0624465	34.705	26.159	0.069	0.26	26.182	0.091	0.35	+0.09
0615409	34.582	26.406	0.077	0.29	26.393	0.088	0.33	-0.05
0623724	34.321	26.371	0.064	0.24	26.283	0.082	0.31	-0.33
0614648	34.634	26.420	0.076	0.29	26.464	0.090	0.34	+0.17
0531737	34.536	26.428	0.059	0.22	26.549	0.084	0.32	+0.46
0628315	34.763	25.744	0.077	0.30	25.728	0.121	0.47	-0.06
0532763	34.540	25.120	0.070	0.28	25.277	0.111	0.44	+0.62
0535466	34.602	25.919	0.060	0.23	26.092	0.084	0.32	+0.67
0622532	34.793	24.651	0.070	0.28	24.680	0.085	0.34	+0.12
0610607	34.336	24.535	0.069	0.28	24.502	0.096	0.39	-0.13
0610239	34.573	25.092	0.071	0.28	25.226	0.084	0.33	+0.54
0624382	34.819	25.597	0.064	0.25	25.804	0.084	0.33	+0.81
0618516	34.821	25.528	0.062	0.24	25.566	0.084	0.33	+0.15
0528325	34.187	23.616	0.076	0.32	23.599	0.085	0.36	-0.07
0536622	34.637	24.279	0.071	0.29	24.419	0.102	0.42	+0.58
0527703	34.446	24.693	0.065	0.26	24.744	0.083	0.34	+0.20
0535154	34.553	24.321	0.065	0.27	24.345	0.084	0.35	+0.10
0411534	23.967	17.829	0.070	0.39	17.860	0.071	0.40	+0.18
0411056	24.033	17.980	0.052	0.29	18.057	0.067	0.37	+0.43
0315310	19.120	15.670	0.070	0.45	15.773	0.080	0.51	+0.66
0312083	19.151	15.734	0.057	0.36	15.748	0.078	0.50	+0.09
0217061	14.350	14.065	0.046	0.33	14.181	0.067	0.47	+0.83
0202635	14.342	14.056	0.045	0.32	14.174	0.078	0.55	+0.84
0705084	14.225	14.208	0.044	0.31	14.267	0.105	0.74	+0.41
0216356	14.371	14.023	0.051	0.36	14.099	0.069	0.49	+0.54
0106614	14.268	13.762	0.042	0.30	13.805	0.062	0.45	+0.31

Table 28

Seed Module III-1 Fissile Fuel Loadings in Grams

Rod No.	As-Built Loading	PIFAG Thermal			PIFAG Epithermal			Epithermal - Thermal Percent Difference
		Loading	Standard Deviation		Loading	Standard Deviation		
			Grams	%		Grams	%	
0600633	34.439	27.188	0.076	0.28	27.182	0.083	0.31	-0.02
0505362	34.610	27.191	0.072	0.26	27.298	0.077	0.28	+0.40
0608349	34.699	27.617	0.063	0.23	27.667	0.071	0.26	+0.18
0506388	34.128	26.741	0.059	0.22	26.776	0.067	0.25	+0.13
0507039	34.636	26.978	0.061	0.23	27.026	0.067	0.25	+0.18
0510139	34.726	27.241	0.074	0.27	27.382	0.067	0.25	+0.52
0502200	34.596	27.444	0.058	0.21	27.603	0.068	0.25	+0.56
0602108	34.555	27.024	0.055	0.20	26.982	0.067	0.25	-0.16
0604876	34.524	26.729	0.057	0.21	26.714	0.067	0.25	-0.06
0603684	34.529	26.672	0.058	0.22	26.615	0.110	0.41	-0.21
0604472	34.544	27.316	0.057	0.21	27.487	0.067	0.24	+0.63
0506206	34.442	26.329	0.070	0.27	26.314	0.070	0.27	-0.06
0504363	34.596	27.309	0.063	0.23	27.542	0.066	0.24	+0.85
0508617	34.622	27.157	0.056	0.21	27.302	0.066	0.24	+0.54
0500385	34.463	26.270	0.060	0.23	26.288	0.067	0.25	+0.07
0501808	34.735	26.275	0.068	0.26	26.325	0.068	0.26	+0.19
0506453	34.341	25.703	0.061	0.24	25.825	0.078	0.30	+0.47
0502585	34.242	26.928	0.058	0.22	27.020	0.066	0.24	+0.34
0600430	34.518	25.321	0.064	0.25	25.360	0.063	0.25	+0.15
0602878	34.292	25.451	0.065	0.26	25.666	0.103	0.40	+0.85
0503622	34.390	24.827	0.064	0.26	24.860	0.067	0.27	+0.13
0504556	34.426	24.681	0.068	0.27	24.784	0.079	0.32	+0.41
0508451	34.726	25.104	0.062	0.25	25.078	0.067	0.27	-0.10
0508671	34.674	26.276	0.057	0.22	26.391	0.081	0.31	+0.44
0508516	34.736	25.975	0.059	0.23	26.012	0.061	0.23	+0.14
0407702	23.897	18.124	0.056	0.31	18.102	0.060	0.33	-0.12
0400083	23.813	18.763	0.047	0.25	18.774	0.057	0.30	+0.06
0302845	19.141	15.917	0.049	0.31	15.983	0.054	0.34	+0.42
0302203	19.132	15.778	0.050	0.32	15.785	0.055	0.35	+0.04
0203652	14.232	14.196	0.037	0.26	14.224	0.039	0.27	+0.20
0201342	14.300	14.276	0.031	0.22	14.316	0.052	0.36	+0.28
0701153	14.250	14.208	0.039	0.27	14.076	0.050	0.35	-0.93
0100683	14.332	13.835	0.041	0.29	13.982	0.051	0.36	+1.06
0102609	14.240	13.765	0.039	0.29	13.681	0.052	0.38	-0.62

Table 29

Seed Module III-2 Fissile Fuel Loadings in Grams

Rod No.	As-Built Loading	PIFAG Thermal			PIFAG Epithermal			Epithermal - Thermal Percent Difference
		Loading	Standard Deviation		Loading	Standard Deviation		
	Grams		%	Grams		%		
0537510	34.843	27.282	0.057	0.21	27.455	0.066	0.24	+0.63
0627076	34.534	27.507	0.063	0.23	27.579	0.066	0.24	+0.26
0537069	34.828	27.287	0.063	0.23	27.462	0.061	0.22	+0.64
0518333	34.501	27.086	0.060	0.22	27.065	0.057	0.21	-0.08
0606874	34.529	27.055	0.086	0.32	27.146	0.067	0.25	+0.34
0607561	34.466	26.585	0.075	0.28	26.785	0.067	0.25	+0.75
0601558	34.513	27.347	0.055	0.20	27.430	0.065	0.24	+0.30
0615216	34.483	27.465	0.054	0.20	27.576	0.083	0.30	+0.40
0516133	34.378	26.706	0.062	0.23	26.820	0.057	0.21	+0.43
0532120	34.815	26.747	0.062	0.23	26.881	0.061	0.23	+0.50
0536272	34.582	26.832	0.095	0.35	27.093	0.061	0.23	+0.97
0622889	34.474	26.632	0.057	0.21	26.666	0.061	0.23	+0.13
0618543	34.474	26.526	0.057	0.22	26.671	0.076	0.29	+0.54
0610275	34.438	27.157	0.055	0.20	27.244	0.065	0.24	+0.32
0608753	34.655	27.225	0.058	0.21	27.423	0.069	0.25	+0.73
0511625	34.596	26.484	0.061	0.23	26.552	0.053	0.20	+0.25
0517269	34.696	26.925	0.055	0.21	26.960	0.066	0.25	+0.13
0613676	34.686	25.860	0.061	0.23	25.774	0.072	0.28	-0.34
0630680	34.478	25.312	0.062	0.25	25.410	0.066	0.26	+0.39
0617865	34.321	26.257	0.056	0.21	26.464	0.089	0.34	+0.79
0624824	34.702	26.671	0.052	0.19	26.735	0.064	0.24	+0.24
0524302	34.636	25.012	0.067	0.27	25.121	0.060	0.24	+0.43
0526336	34.626	24.567	0.073	0.30	24.543	0.067	0.27	-0.10
0531728	34.516	24.768	0.065	0.26	24.758	0.078	0.31	-0.04
0523779	34.542	25.727	0.075	0.29	25.775	0.064	0.25	+0.19
0412652	23.966	18.064	0.056	0.31	18.072	0.049	0.27	+0.04
0408755	23.981	18.835	0.050	0.27	18.915	0.053	0.28	+0.42
0314384	19.179	15.842	0.051	0.32	15.879	0.054	0.34	+0.23
0315127	19.187	16.359	0.041	0.25	16.442	0.076	0.46	+0.50
0207428	14.292	14.220	0.042	0.29	14.379	0.051	0.35	+1.12
0202525	14.154	14.255	0.032	0.23	14.199	0.049	0.34	-0.39
0105624	14.445	14.087	0.046	0.32	14.081	0.051	0.36	-0.04
0106089	14.435	14.000	0.040	0.28	14.018	0.045	0.32	+0.13

Table 30

Blanket Module I-3 RB Rod Fissile Fuel Loadings in Grams

Rod No.	As-Built Loading	PIFAG Thermal			PIFAG Epithermal			Epithermal - Thermal Percent Difference
		Loading	Standard Deviation		Loading	Standard Deviation		
Grams	%		Grams	%				
1208078	16.473	36.219	0.091	0.25	36.221	0.110	0.30	+0.00
1200665	16.442	36.058	0.090	0.25	35.997	0.103	0.29	-0.17
1200500	16.458	35.899	0.088	0.25	35.847	0.104	0.29	-0.14
1200830	16.454	36.884	0.097	0.26	36.796	0.081	0.22	-0.24
1107750	16.488	36.848	0.098	0.27	36.829	0.112	0.30	-0.05
1105477	16.502	35.122	0.081	0.23	35.387	0.101	0.29	+0.76
1208042	16.440	34.852	0.078	0.22	34.910	0.086	0.25	+0.16
1107623	16.469	34.967	0.082	0.23	34.787	0.092	0.27	-0.51
1103700	16.493	34.980	0.081	0.23	35.239	0.083	0.24	+0.74
1206347	16.461	35.341	0.083	0.23	35.469	0.094	0.27	+0.36
1106844	16.471	35.875	0.087	0.24	35.874	0.096	0.27	-0.00
1401166	30.494	40.877	0.091	0.22	40.902	0.128	0.31	+0.06
1400544	30.673	40.711	0.091	0.22	40.756	0.072	0.18	+0.11
1404356	30.051	40.043	0.099	0.25	40.404	0.133	0.33	+0.90
1411479	30.006	40.477	0.105	0.26	40.538	0.122	0.30	+0.15
1407187	30.515	41.183	0.106	0.26	41.345	0.109	0.26	+0.39
1306584	45.527	47.179	0.121	0.26	47.226	0.136	0.29	+0.10
1311738	45.432	47.107	0.118	0.25	47.177	0.140	0.30	+0.15
1302864	45.461	47.355	0.128	0.27	47.384	0.113	0.24	+0.06
1302873	45.443	47.397	0.128	0.27	47.430	0.132	0.28	+0.07
1311811	45.433	47.463	0.121	0.26	47.648	0.142	0.30	+0.39
1307152	45.427	47.749	0.149	0.31	47.709	0.166	0.35	-0.08
1510589	45.798	48.379	0.121	0.25	48.446	0.123	0.25	+0.14
1507058	45.808	47.928	0.117	0.24	47.957	0.118	0.25	+0.06
1506683	45.836	48.188	0.116	0.24	48.155	0.142	0.29	-0.07
1500386	45.752	48.422	0.142	0.29	48.437	0.126	0.26	+0.03
1500846	45.779	48.682	0.133	0.27	48.779	0.144	0.30	+0.20
1500157	45.808	48.491	0.129	0.27	48.279	0.127	0.26	-0.44
1503742	45.653	48.463	0.152	0.31	48.439	0.126	0.26	-0.05
1605876	54.491	52.386	0.123	0.23	52.576	0.148	0.28	+0.36
1612357	54.471	52.526	0.178	0.34	52.704	0.148	0.28	+0.34
1606278	54.452	52.512	0.152	0.29	52.636	0.159	0.30	+0.24
1605519	54.553	52.514	0.154	0.29	52.471	0.146	0.28	-0.08
1604318	54.748	52.542	0.138	0.26	52.705	0.158	0.30	+0.31
1604758	54.540	52.576	0.136	0.26	52.812	0.150	0.28	+0.45
1610157	54.503	52.579	0.133	0.25	52.602	0.180	0.34	+0.04

Table 31

Blanket Module II-2 RB Rod Fissile Fuel Loadings in Grams

<u>Rod No.</u>	<u>As-Built Loading</u>	<u>PIFAG Thermal</u>			<u>PIFAG Epithermal</u>			<u>Epithermal - Thermal Percent Difference</u>
		<u>Loading</u>	<u>Standard Deviation Grams</u>	<u>%</u>	<u>Loading</u>	<u>Standard Deviation Grams</u>	<u>%</u>	
1210125	16.463	36.098	0.089	0.25	35.880	0.094	0.26	-0.60
1210226	16.484	35.977	0.091	0.25	35.804	0.086	0.24	-0.48
1103672	16.379	35.854	0.095	0.27	35.784	0.108	0.30	-0.19
1208657	16.475	34.293	0.076	0.22	34.260	0.100	0.29	-0.10
1106137	16.480	33.513	0.070	0.21	33.608	0.116	0.35	+0.28
1106586	16.457	34.134	0.078	0.23	33.948	0.109	0.32	-0.54
1104525	16.403	34.882	0.081	0.23	34.959	0.121	0.35	+0.22
1102470	16.404	33.962	0.075	0.22	33.954	0.109	0.32	-0.02
1404668	30.083	39.917	0.099	0.25	39.980	0.120	0.30	+0.16
1412846	30.607	40.829	0.105	0.26	40.960	0.159	0.39	+0.32
1407748	30.248	40.012	0.098	0.25	40.032	0.145	0.36	+0.05
1402660	30.038	39.462	0.092	0.23	39.319	0.117	0.30	-0.36
1303248	45.523	46.165	0.110	0.24	46.457	0.179	0.39	+0.63
1302579	45.273	46.937	0.121	0.26	47.344	0.160	0.34	+0.87
1311334	45.511	47.133	0.140	0.30	47.683	0.192	0.40	+1.17
1305787	45.408	46.736	0.108	0.23	46.968	0.163	0.35	+0.50
1505363	45.489	47.766	0.112	0.23	47.806	0.112	0.23	+0.09
1504658	45.754	48.090	0.122	0.25	47.943	0.140	0.29	-0.31
1507619	45.679	48.454	0.133	0.27	48.376	0.176	0.36	-0.16
1504667	45.638	47.729	0.116	0.24	47.829	0.135	0.28	+0.21
1608083	54.657	51.750	0.112	0.22	52.121	0.136	0.26	+0.72
1603676	54.855	52.624	0.133	0.25	52.883	0.157	0.30	+0.49
1607479	54.600	52.492	0.132	0.25	52.784	0.182	0.35	+0.56
1602181	54.636	52.628	0.131	0.25	52.831	0.166	0.31	+0.39

Table 32

Blanket Module III-2 RB Rod Fissile Fuel Loadings in Grams

<u>Rod No.</u>	<u>As-Built Loading</u>	<u>PIFAG Thermal</u>			<u>PIFAG Epithermal</u>			<u>Epithermal - Thermal Percent Difference</u>
		<u>Loading</u>	<u>Standard Deviation</u>		<u>Loading</u>	<u>Standard Deviation</u>		
			<u>Grams</u>	<u>%</u>		<u>Grams</u>	<u>%</u>	
1105102	16.460	33.860	0.076	0.23	33.778	0.103	0.30	-0.24
1103012	16.425	34.105	0.076	0.22	34.072	0.104	0.30	-0.10
1207520	16.437	33.727	0.070	0.21	33.774	0.103	0.30	+0.14
1203709	16.389	33.824	0.113	0.33	33.868	0.103	0.30	+0.13
1100767	16.477	33.741	0.090	0.27	33.527	0.101	0.30	-0.63
1103460	16.394	32.532	0.075	0.23	32.497	0.100	0.31	-0.11
1402542	30.639	39.894	0.091	0.23	39.849	0.112	0.28	-0.11
1401828	30.192	39.566	0.091	0.23	39.716	0.103	0.26	+0.38
1410316	30.029	38.283	0.078	0.20	38.356	0.107	0.28	+0.19
1310187	45.413	46.101	0.109	0.24	46.110	0.125	0.27	+0.02
1310472	45.393	46.852	0.110	0.23	46.775	0.132	0.28	-0.16
1303872	45.563	47.082	0.115	0.24	47.246	0.163	0.34	+0.35
1514365	45.736	47.829	0.125	0.26	47.660	0.172	0.36	-0.35
1513339	45.714	48.186	0.117	0.24	48.227	0.148	0.31	+0.08
1511469	45.735	47.058	0.106	0.23	47.190	0.122	0.26	+0.28
1607416	54.562	51.499	0.110	0.21	51.608	0.133	0.26	+0.21
1607075	54.546	52.264	0.116	0.22	52.389	0.138	0.26	+0.24
1615502	54.667	52.743	0.125	0.24	52.512	0.142	0.27	-0.44

Table 33

Blanket Module III-6 RB Rod Fissile Fuel Loadings in Grams

Rod No.	As-Built Loading	PIFAG Thermal			PIFAG Epithermal			Epithermal - Thermal Percent Difference
		Loading	Standard Deviation		Loading	Standard Deviation		
	Grams		%	Grams		%		
1204542	16.457	34.555	0.084	0.24	34.721	0.108	0.31	+0.48
1200344	16.439	34.673	0.086	0.25	34.612	0.119	0.34	-0.18
1103443	16.450	34.117	0.079	0.23	34.134	0.127	0.37	+0.05
1101059	16.487	32.896	0.070	0.21	32.999	0.092	0.28	+0.31
1103315	16.399	33.108	0.076	0.23	32.994	0.094	0.29	-0.34
1104800	16.508	33.843	0.077	0.23	33.829	0.104	0.31	-0.04
1401882	30.705	38.748	0.085	0.22	38.943	0.110	0.28	+0.50
1404448	30.475	39.888	0.092	0.23	39.845	0.130	0.33	-0.11
1410646	30.523	38.704	0.082	0.21	38.891	0.129	0.33	+0.48
1306117	45.353	46.296	0.108	0.23	46.276	0.129	0.28	-0.04
1308564	45.529	46.917	0.118	0.25	47.065	0.169	0.36	+0.32
1305724	45.584	46.880	0.118	0.25	46.912	0.172	0.37	+0.07
1507545	45.760	47.751	0.109	0.23	47.770	0.117	0.25	+0.04
1513265	45.581	48.214	0.120	0.25	48.080	0.159	0.33	-0.28
1512486	45.619	47.736	0.111	0.23	47.815	0.125	0.26	+0.17
1603483	54.704	52.461	0.127	0.24	52.625	0.147	0.28	+0.31
1613457	54.482	52.333	0.135	0.26	52.640	0.178	0.34	+0.59
1601164	54.671	51.791	0.113	0.22	52.031	0.138	0.27	+0.46

Table 34

Blanket Module II-2 PFB Rod Fissile Fuel Loadings in Grams

Rod No.	As-Built Loading	PIFAG Thermal			PIFAG Epithermal			Epithermal - Thermal Percent Difference
		Loading	Standard Deviation Grams	%	Loading	Standard Deviation Grams	%	
2104416	18.977	31.138	0.086	0.28	31.054	0.131	0.42	-0.27
2103352	18.997	31.004	0.085	0.28	30.808	0.150	0.49	-0.63
2102225	18.985	30.632	0.086	0.28	30.606	0.096	0.31	-0.08
2102077	18.894	30.799	0.085	0.28	30.723	0.106	0.35	-0.25
2100245	18.925	30.416	0.079	0.26	30.415	0.087	0.29	-0.01
2405522	30.723	34.446	0.076	0.22	34.588	0.104	0.30	+0.41
2400287	30.771	35.286	0.109	0.31	35.228	0.101	0.29	-0.16
2406153	30.751	34.955	0.094	0.27	34.785	0.094	0.27	-0.49
2304138	52.563	45.815	0.129	0.28	45.864	0.147	0.32	+0.11
2303552	52.787	46.012	0.116	0.25	45.904	0.117	0.25	-0.23
2303560	52.787	45.919	0.110	0.24	46.031	0.128	0.28	+0.24
2610223	62.732	54.709	0.111	0.20	54.921	0.118	0.21	+0.39
2613505	63.183	54.060	0.115	0.21	54.309	0.128	0.24	+0.46
2610205	63.037	52.424	0.127	0.24	52.433	0.132	0.25	+0.02
2607600	63.042	51.687	0.135	0.26	51.714	0.128	0.25	+0.05
2620655	63.103	53.790	0.112	0.21	53.901	0.162	0.30	+0.21
2606389	62.571	53.904	0.107	0.20	53.962	0.118	0.22	+0.11
2504834	63.032	56.303	0.111	0.20	56.602	0.122	0.22	+0.53
2516759	63.108	54.553	0.121	0.22	54.547	0.121	0.22	-0.01
2517289	62.944	54.104	0.120	0.22	54.521	0.129	0.24	+0.77
2505025	63.122	53.528	0.124	0.23	54.027	0.137	0.25	+0.18
2518371	63.061	54.772	0.111	0.20	54.851	0.126	0.23	+0.14
2614769	63.115	54.475	0.113	0.21	54.791	0.113	0.21	+0.58
2610883	63.105	53.451	0.123	0.23	53.416	0.103	0.19	-0.07
2618866	63.394	54.400	0.120	0.22	54.706	0.122	0.22	+0.56
2608003	63.226	55.501	0.118	0.21	55.697	0.122	0.22	+0.35
2511663	63.033	55.335	0.138	0.25	55.206	0.133	0.24	-0.23
2504585	62.926	54.896	0.110	0.20	55.166	0.141	0.26	+0.49
2504347	62.838	54.750	0.121	0.22	54.721	0.111	0.20	-0.05
2516061	63.183	52.554	0.144	0.27	52.529	0.121	0.23	-0.05
2518142	62.980	54.576	0.114	0.21	54.554	0.129	0.24	-0.04
2617106	63.369	55.858	0.113	0.20	56.096	0.116	0.21	+0.42
2605583	62.732	55.354	0.106	0.19	55.359	0.123	0.22	+0.01
2616776	63.361	54.594	0.107	0.20	54.851	0.175	0.32	+0.47
2520288	62.914	53.976	0.105	0.20	54.223	0.115	0.21	+0.46
2513717	63.054	52.891	0.120	0.23	52.853	0.145	0.27	-0.07
2517823	62.702	52.225	0.125	0.24	52.152	0.118	0.23	-0.14
2504706	62.510	52.704	0.105	0.20	52.600	0.143	0.27	-0.20
2506814	63.221	54.818	0.102	0.19	54.822	0.116	0.21	+0.01
2701357	46.528	42.750	0.121	0.28	42.695	0.144	0.34	-0.13
2700055	46.187	42.474	0.120	0.28	42.392	0.116	0.27	-0.19

Table 35

Blanket Module III-2 PFB Rod Fissile Fuel Loadings in Grams

Rod No.	As-Built Loading	PIFAG Thermal			PIFAG Epithermal			Epithermal - Thermal Percent Difference
		Loading	Standard Deviation Grams	%	Loading	Standard Deviation Grams	%	
2202278	18.912	30.067	0.080	0.27	29.982	0.094	0.31	-0.28
2200805	18.907	30.548	0.079	0.26	30.503	0.117	0.38	-0.15
2100759	18.990	28.529	0.059	0.21	28.627	0.095	0.33	+0.34
2201178	18.913	28.105	0.059	0.21	28.079	0.085	0.30	-0.09
2202518	18.894	29.381	0.069	0.23	29.419	0.090	0.30	+0.13
2101758	18.894	29.609	0.070	0.23	29.338	0.090	0.31	-0.92
2402314	30.763	33.718	0.072	0.21	33.824	0.145	0.43	+0.32
2401048	30.769	34.312	0.078	0.23	34.432	0.111	0.32	+0.35
2401636	30.876	34.402	0.075	0.22	34.488	0.123	0.36	+0.25
2300601	52.531	46.680	0.092	0.20	46.821	0.110	0.24	+0.30
2300279	52.669	46.507	0.088	0.19	46.857	0.142	0.30	+0.75
2304652	52.765	45.950	0.105	0.23	46.003	0.118	0.26	+0.12
2302378	52.514	45.692	0.104	0.23	45.736	0.105	0.23	+0.10
2620509	63.028	55.998	0.097	0.17	56.247	0.114	0.20	+0.44
2603383	63.177	55.581	0.127	0.23	55.758	0.118	0.21	+0.32
2606775	63.024	54.587	0.107	0.20	54.585	0.150	0.28	-0.00
2600653	63.039	53.799	0.111	0.21	53.862	0.118	0.22	+0.12
2611002	63.067	53.403	0.117	0.22	53.741	0.143	0.27	+0.63
2608755	62.826	51.301	0.162	0.32	51.570	0.125	0.24	+0.53
2515513	62.860	56.244	0.100	0.18	56.122	0.142	0.25	-0.22
2517363	62.964	55.952	0.106	0.19	56.040	0.172	0.31	+0.16
2516777	62.965	55.740	0.101	0.18	56.166	0.116	0.21	+0.76
2511810	63.128	53.149	0.121	0.23	53.258	0.113	0.21	+0.20
2520656	63.103	54.400	0.130	0.24	54.738	0.131	0.24	+0.62
2516850	63.083	54.651	0.111	0.20	54.895	0.187	0.34	+0.45
2615016	62.991	56.980	0.126	0.22	57.207	0.157	0.27	+0.40
2601147	62.998	57.018	0.100	0.18	57.018	0.113	0.20	-0.00
2607031	62.956	56.721	0.103	0.18	57.033	0.114	0.20	+0.55
2602375	63.137	56.947	0.100	0.17	57.369	0.120	0.21	+0.74
2621407	62.964	55.324	0.106	0.19	55.636	0.108	0.19	+0.56
2608434	62.901	54.431	0.110	0.20	54.882	0.118	0.21	+0.83
2607325	63.161	52.721	0.112	0.21	52.865	0.088	0.17	+0.27
2605455	62.956	54.487	0.113	0.21	54.784	0.118	0.22	+0.54
2622433	63.145	54.942	0.110	0.20	55.158	0.110	0.20	+0.39
2622478	62.916	57.100	0.134	0.23	57.408	0.129	0.22	+0.54
2517704	62.780	56.768	0.098	0.17	57.185	0.113	0.20	+0.73
2511350	62.971	57.030	0.096	0.17	57.153	0.114	0.20	+0.22
2516281	63.138	55.888	0.099	0.18	55.743	0.108	0.19	-0.26
2512754	62.975	55.733	0.101	0.18	56.028	0.126	0.22	+0.53

Table 35 (Continued)

Blanket Module III-2 PFB Rod Fissile Fuel Loadings in Grams

<u>Rod No.</u>	<u>As-Built Loading</u>	<u>PIFAG Thermal</u>			<u>PIFAG Epithermal</u>			<u>Epithermal - Thermal Percent Difference</u>
		<u>Loading</u>	<u>Standard Deviation</u>		<u>Loading</u>	<u>Standard Deviation</u>		
			<u>Grams</u>	<u>%</u>		<u>Grams</u>	<u>%</u>	
2517244	62.948	56.010	0.100	0.18	56.290	0.114	0.20	+0.50
2517179	63.154	57.001	0.093	0.16	56.995	0.113	0.20	-0.01
2607563	63.014	57.091	0.098	0.17	57.314	0.126	0.22	+0.39
2603044	63.137	56.345	0.109	0.19	56.311	0.111	0.20	-0.06
2607471	62.989	56.077	0.119	0.21	56.214	0.104	0.19	+0.25
2611157	62.879	54.302	0.106	0.20	54.530	0.132	0.24	+0.42
2614640	63.134	54.418	0.103	0.19	54.699	0.116	0.21	+0.52
2610240	62.777	55.818	0.101	0.18	56.172	0.104	0.19	+0.63
2605152	62.950	57.039	0.094	0.17	57.217	0.113	0.20	+0.31
2502082	63.030	56.423	0.092	0.16	56.449	0.192	0.34	+0.04
2521022	63.033	56.277	0.097	0.17	56.379	0.112	0.20	+0.18
2518041	63.129	55.722	0.095	0.17	55.710	0.096	0.17	-0.02
2515585	63.070	55.428	0.119	0.22	55.488	0.112	0.20	+0.11
2516503	62.960	53.904	0.115	0.21	53.670	0.106	0.20	-0.43
2514128	63.172	54.478	0.156	0.29	54.417	0.112	0.21	-0.11
2516319	63.066	55.902	0.098	0.17	55.869	0.111	0.20	-0.06
2700643	46.374	42.939	0.110	0.26	43.143	0.112	0.26	+0.47
2701274	46.300	43.035	0.138	0.32	42.845	0.117	0.27	-0.44

Table 36

Blanket Module III-6 PFB Rod Fissile Fuel Loadings in Grams

Rod No.	As-Built Loading	PIFAG Thermal			PIFAG Epithermal			Epithermal - Thermal Percent Difference
		Loading	Standard Deviation Grams	%	Loading	Standard Deviation Grams	%	
2204855	18.997	29.110	0.063	0.22	29.154	0.088	0.30	+0.15
2204846	18.998	30.389	0.087	0.28	30.264	0.088	0.29	-0.41
2200840	18.977	29.275	0.071	0.24	29.282	0.090	0.31	+0.02
2101363	18.993	28.354	0.062	0.22	28.304	0.087	0.31	-0.18
2101464	18.980	28.964	0.092	0.32	28.820	0.094	0.32	-0.50
2102187	18.997	29.367	0.056	0.19	29.318	0.049	0.17	-0.17
2400408	30.780	33.914	0.054	0.16	34.018	0.053	0.16	+0.31
2406355	30.720	34.791	0.082	0.23	34.891	0.096	0.28	+0.29
2404018	30.802	33.952	0.078	0.23	34.003	0.093	0.27	+0.15
2305853	52.402	46.515	0.086	0.18	46.712	0.102	0.22	+0.42
2305449	52.385	46.629	0.093	0.20	46.415	0.108	0.23	-0.46
2300711	52.511	45.364	0.104	0.23	45.350	0.077	0.17	-0.03
2305312	52.551	45.734	0.106	0.23	45.975	0.114	0.25	+0.53
2612735	63.218	56.216	0.128	0.23	56.189	0.120	0.21	-0.05
2600314	63.295	55.488	0.118	0.21	55.482	0.119	0.21	-0.01
2622083	62.976	55.995	0.108	0.19	55.896	0.187	0.33	-0.18
2617005	63.090	56.536	0.109	0.19	56.587	0.121	0.21	+0.09
2612827	62.967	54.296	0.111	0.21	54.418	0.123	0.23	+0.23
2600745	63.053	53.214	0.124	0.23	53.525	0.125	0.23	+0.58
2604887	63.264	53.165	0.115	0.22	53.424	0.112	0.21	+0.49
2606481	63.116	51.575	0.115	0.22	51.624	0.082	0.16	+0.09
2503808	63.193	56.424	0.108	0.19	56.650	0.112	0.20	+0.40
2514045	63.138	56.710	0.120	0.21	56.610	0.151	0.27	-0.18
2512579	63.142	56.679	0.108	0.19	56.744	0.146	0.26	+0.11
2517226	62.858	55.472	0.119	0.22	55.650	0.120	0.22	+0.32
2513854	63.272	53.670	0.101	0.19	53.752	0.076	0.14	+0.15
2502578	63.238	54.631	0.115	0.21	54.650	0.113	0.21	+0.04
2510738	62.935	54.755	0.129	0.24	54.876	0.121	0.22	+0.22
2517208	63.451	54.944	0.110	0.20	55.122	0.122	0.22	+0.32
2616684	62.794	56.311	0.137	0.24	56.632	0.163	0.29	+0.57
2600377	62.449	56.691	0.105	0.19	56.722	0.153	0.27	+0.06
2606876	62.938	55.919	0.136	0.24	56.187	0.187	0.33	+0.48
2601367	63.052	55.776	0.150	0.27	55.753	0.122	0.22	-0.04
2620747	62.967	55.066	0.112	0.20	55.312	0.128	0.23	+0.45
2612625	63.108	55.213	0.113	0.20	55.442	0.124	0.22	+0.41
2613413	63.193	56.010	0.109	0.20	56.179	0.113	0.20	+0.30
2502102	62.999	57.295	0.073	0.13	57.440	0.070	0.12	+0.25
2505236	63.207	57.413	0.104	0.18	57.527	0.149	0.26	+0.20
2516824	62.952	56.808	0.104	0.18	57.021	0.119	0.21	+0.38

Table 36 (Continued)

Blanket Module III-6 PFB Rod Fissile Fuel Loadings in Grams

<u>Rod No.</u>	<u>As-Built Loading</u>	<u>PIFAG Thermal</u>			<u>PIFAG Epithermal</u>			<u>Epithermal - Thermal Percent Difference</u>
		<u>Loading</u>	<u>Standard Deviation Grams</u>	<u>%</u>	<u>Loading</u>	<u>Standard Deviation Grams</u>	<u>%</u>	
2500618	63.204	57.485	0.125	0.22	57.519	0.113	0.20	+0.06
2500589	63.127	56.389	0.119	0.21	56.655	0.125	0.22	+0.47
2503018	62.711	55.376	0.108	0.20	55.429	0.120	0.22	+0.10
2622175	63.162	56.680	0.104	0.18	57.041	0.110	0.19	+0.64
2610167	62.934	56.988	0.142	0.25	57.173	0.121	0.21	+0.32
2615512	63.205	57.207	0.102	0.18	57.224	0.152	0.27	+0.03
2622617	63.366	57.336	0.117	0.20	57.287	0.134	0.23	-0.08
2607509	63.011	56.533	0.186	0.33	56.878	0.132	0.23	+0.61
2605502	63.280	53.224	0.116	0.22	53.606	0.124	0.23	+0.72
2622507	63.002	55.019	0.107	0.19	55.047	0.145	0.26	+0.05
2513880	63.239	56.656	0.140	0.25	56.308	0.129	0.23	-0.61
2518169	63.144	54.956	0.100	0.18	55.134	0.158	0.29	+0.32
2507720	63.226	52.943	0.116	0.22	52.874	0.120	0.23	-0.13
2501670	63.187	52.467	0.115	0.22	52.478	0.120	0.23	+0.02
2513634	63.122	54.042	0.110	0.20	53.700	0.133	0.25	-0.63
2501157	63.199	56.730	0.116	0.20	56.300	0.167	0.30	-0.76
2700414	46.562	42.732	0.125	0.29	42.852	0.117	0.27	+0.28
2701430	46.217	42.883	0.119	0.28	42.726	0.116	0.27	-0.37

Table 37

Reflector Module IV-3 Fissile Fuel Loadings in Grams

Rod No.	As-Built Loading	PIFAG Thermal			PIFAG Epithermal			Epithermal - Thermal Percent Difference
		Loading	Standard Deviation Grams	%	Loading	Standard Deviation Grams	%	
3222566	0.000	6.904	0.024	0.35	6.785	0.099	1.46	-1.72
3224023	0.000	6.566	0.020	0.31	6.380	0.105	1.64	-2.83
3214250	0.000	4.513	0.021	0.46	4.405	0.118	2.69	-2.39
3126159	0.000	4.088	0.021	0.50	3.999	0.133	3.33	-2.18
3117560	0.000	6.260	0.018	0.29	6.117	0.120	1.97	-2.28
3102583	0.000	5.013	0.020	0.40	4.765	0.124	2.61	-4.95
3225085	0.000	11.024	0.026	0.24	10.711	0.111	1.04	-2.85
3115580	0.000	8.131	0.035	0.43	8.034	0.103	1.28	-1.18
3223188	0.000	12.298	0.033	0.27	12.402	0.131	1.06	+0.85
3117709	0.000	11.386	0.024	0.21	11.173	0.131	1.17	-1.87
3213858	0.000	9.089	0.027	0.30	8.719	0.119	1.36	-4.07
3111504	0.000	18.418	0.031	0.17	18.428	0.126	0.68	+0.05
3112815	0.000	15.912	0.038	0.24	15.749	0.114	0.73	-1.03
3120156	0.000	14.928	0.028	0.19	14.651	0.113	0.77	-1.86
3201776	0.000	14.452	0.031	0.22	14.261	0.103	0.72	-1.32
3211429	0.000	17.014	0.040	0.23	16.886	0.127	0.75	-0.75
3211034	0.000	15.086	0.022	0.15	15.002	0.115	0.77	-0.56
3114804	0.000	24.718	0.037	0.15	24.696	0.139	0.56	-0.09
3208834	0.000	22.434	0.038	0.17	22.296	0.147	0.66	-0.61
3110624	0.000	21.798	0.046	0.21	21.509	0.156	0.73	-1.32
3110505	0.000	23.874	0.031	0.13	23.687	0.102	0.43	-0.78
3122879	0.000	20.452	0.077	0.37	20.283	0.119	0.59	-0.82
3102657	0.000	37.346	0.059	0.16	37.163	0.135	0.36	-0.49
3220357	0.000	31.984	0.048	0.15	31.939	0.143	0.45	-0.14
3211456	0.000	34.845	0.052	0.15	34.934	0.111	0.32	+0.26
3207716	0.000	31.203	0.075	0.24	31.172	0.129	0.41	-0.10
3114326	0.000	29.237	0.069	0.23	29.396	0.119	0.40	+0.54
3126022	0.000	28.490	0.034	0.12	28.380	0.124	0.44	-0.39

Table 38

Reflector Module IV-4 Fissile Fuel Loadings in Grams

Rod No.	As-Built Loading	PIFAG Thermal			PIFAG Epithermal			Epithermal - Thermal Percent Difference
		Loading	Standard Deviation		Loading	Standard Deviation		
	Grams		%	Grams		%		
3216258	0.000	8.124	0.026	0.32	8.093	0.120	1.48	-0.39
3203774	0.000	6.148	0.024	0.39	6.225	0.131	2.11	+1.25
3222474	0.000	4.920	0.018	0.36	4.925	0.127	2.57	+0.11
3216139	0.000	6.385	0.025	0.39	6.398	0.112	1.75	+0.19
3120744	0.000	5.239	0.024	0.45	5.242	0.115	2.20	+0.07
3113006	0.000	6.905	0.033	0.48	6.893	0.119	1.73	-0.17
3118019	0.000	6.206	0.026	0.43	6.051	0.117	1.93	-2.49
3218669	0.000	11.718	0.029	0.25	11.544	0.124	1.07	-1.49
3122163	0.000	8.855	0.027	0.30	8.798	0.139	1.58	-0.64
3218413	0.000	14.517	0.027	0.19	14.286	0.133	0.93	-1.59
3123245	0.000	13.375	0.054	0.40	12.999	0.123	0.95	-2.81
3122605	0.000	11.319	0.030	0.27	11.100	0.115	1.03	-1.94
3222833	0.000	9.260	0.024	0.26	9.204	0.121	1.32	-0.60
3104664	0.000	16.343	0.055	0.34	16.177	0.143	0.89	-1.01
3127075	0.000	15.663	0.028	0.18	15.612	0.122	0.78	-0.33
3217506	0.000	16.087	0.069	0.43	15.999	0.215	1.34	-0.55
3105488	0.000	16.326	0.024	0.15	16.181	0.178	1.10	-0.89
3126470	0.000	18.584	0.035	0.19	18.640	0.226	1.21	+0.30
3208127	0.000	22.792	0.039	0.17	22.544	0.135	0.60	-1.09
3118708	0.000	25.674	0.049	0.19	25.442	0.158	0.62	-0.90
3103555	0.000	21.224	0.033	0.16	21.144	0.133	0.63	-0.38
3203379	0.000	21.800	0.062	0.29	21.662	0.135	0.62	-0.63
3203545	0.000	24.727	0.046	0.19	24.703	0.175	0.71	-0.09
3107082	0.000	39.323	0.063	0.16	39.343	0.175	0.45	+0.05
3217266	0.000	36.574	0.057	0.16	36.275	0.173	0.48	-0.82
3211236	0.000	33.092	0.059	0.18	32.948	0.170	0.52	-0.44
3214875	0.000	29.115	0.050	0.17	28.943	0.142	0.49	-0.59
3116167	0.000	35.794	0.055	0.15	36.000	0.140	0.39	+0.58
3220751	0.000	28.963	0.057	0.20	29.081	0.164	0.56	+0.41

Table 39

Reflector Module IV-9 Fissile Fuel Loadings in Grams

Rod No.	As-Built Loading	PIFAG Thermal			PIFAG Epithermal			Epithermal - Thermal Percent Difference
		Loading	Standard Deviation		Loading	Standard Deviation		
	Grams		%	Grams		%		
3124805	0.000	7.593	0.026	0.34	7.334	0.148	2.02	-3.41
3124556	0.000	6.937	0.019	0.28	6.730	0.116	1.72	-2.98
3222815	0.000	7.104	0.026	0.36	7.174	0.135	1.89	+0.99
3218540	0.000	7.359	0.021	0.28	7.383	0.120	1.62	+0.33
3226176	0.000	6.344	0.020	0.32	6.440	0.135	2.10	+1.51
3223529	0.000	5.490	0.017	0.32	5.584	0.136	2.43	+1.69
3111448	0.000	5.590	0.028	0.50	5.423	0.114	2.10	-2.98
3224683	0.000	5.464	0.027	0.50	5.208	0.120	2.30	-4.67
3221530	0.000	5.890	0.018	0.30	5.547	0.126	2.27	-5.82
3222667	0.000	4.827	0.022	0.45	4.878	0.139	2.84	+1.05
3223050	0.000	8.088	0.027	0.33	7.948	0.117	1.48	-1.73
3215048	0.000	5.819	0.021	0.37	5.757	0.158	2.75	-1.07
3220229	0.000	4.648	0.022	0.48	4.616	0.114	2.48	-0.68
3125005	0.000	5.425	0.023	0.43	5.219	0.116	2.22	-3.80
3121265	0.000	4.955	0.023	0.46	4.782	0.135	2.83	-3.50
3124886	0.000	4.713	0.017	0.37	4.574	0.114	2.48	-2.94
3207256	0.000	7.305	0.026	0.35	7.198	0.117	1.63	-1.47
3121476	0.000	5.140	0.031	0.60	5.136	0.170	3.31	-0.08
3121173	0.000	4.736	0.030	0.63	4.613	0.114	2.47	-2.60
3104417	0.000	4.647	0.022	0.47	4.688	0.114	2.44	+0.88
3223152	0.000	13.737	0.031	0.23	13.600	0.129	0.95	-0.99
3224564	0.000	13.188	0.028	0.21	12.958	0.190	1.46	-1.74
3218743	0.000	10.658	0.042	0.39	10.599	0.123	1.16	-0.56
3202757	0.000	9.222	0.029	0.32	9.013	0.163	1.81	-2.27
3126140	0.000	8.692	0.025	0.29	8.662	0.119	1.37	-0.33
3211135	0.000	13.133	0.047	0.35	12.926	0.136	1.05	-1.58
3225783	0.000	9.390	0.028	0.30	9.234	0.136	1.48	-1.65
3222135	0.000	10.652	0.026	0.24	10.701	0.119	1.12	+0.46
3224748	0.000	9.696	0.024	0.25	9.651	0.151	1.56	-0.47
3218844	0.000	10.854	0.029	0.27	10.688	0.113	1.06	-1.53
3121586	0.000	11.361	0.030	0.27	11.151	0.119	1.07	-1.85
3125389	0.000	8.823	0.027	0.31	8.577	0.116	1.36	-2.78
3224739	0.000	13.716	0.033	0.24	13.562	0.129	0.95	-1.13
3221448	0.000	20.296	0.035	0.17	20.313	0.128	0.63	+0.08
3221659	0.000	16.077	0.054	0.34	15.821	0.117	0.74	-1.59
3123474	0.000	20.216	0.044	0.22	19.939	0.127	0.64	-1.37
3123135	0.000	17.233	0.038	0.22	17.126	0.190	1.11	-0.62
3122513	0.000	15.744	0.032	0.20	15.768	0.116	0.73	+0.15
3220404	0.000	26.358	0.046	0.17	26.405	0.134	0.51	+0.18
3123263	0.000	21.170	0.031	0.15	21.113	0.179	0.85	-0.27
3120165	0.000	21.654	0.040	0.19	21.668	0.120	0.56	+0.06
3218577	0.000	27.276	0.050	0.18	27.068	0.134	0.49	-0.76
3221062	0.000	20.679	0.046	0.22	20.643	0.136	0.66	-0.18
3100282	0.000	39.550	0.074	0.19	39.687	0.147	0.37	+0.35
3123236	0.000	35.777	0.060	0.17	35.766	0.158	0.44	-0.03
3118836	0.000	31.837	0.061	0.19	31.806	0.168	0.53	-0.10
3206542	0.000	29.191	0.053	0.18	29.033	0.135	0.47	-0.54
3120376	0.000	27.846	0.050	0.18	28.005	0.179	0.64	+0.57

Table 40

Reflector Module V-4 Fissile Fuel Loadings in Grams

Rod No.	As-Built Loading	PIFAG Thermal			PIFAG Epithermal			Epithermal - Thermal Percent Difference
		Loading	Standard Deviation		Loading	Standard Deviation		
	Grams		%	Grams		%		
3200815	0.000	6.947	0.021	0.30	6.994	0.168	2.40	+0.68
3106846	0.000	7.723	0.025	0.33	7.581	0.118	1.56	-1.84
3201464	0.000	7.309	0.025	0.35	7.279	0.113	1.55	-0.42
3204810	0.000	6.958	0.033	0.48	6.932	0.119	1.71	-0.37
3106635	0.000	5.663	0.018	0.32	5.681	0.116	2.05	+0.32
3102620	0.000	6.436	0.020	0.32	6.294	0.120	1.90	-2.22
3208852	0.000	4.763	0.019	0.40	4.742	0.126	2.65	-0.43
3223675	0.000	5.372	0.024	0.45	5.353	0.117	2.19	-0.35
3111513	0.000	4.888	0.022	0.46	4.796	0.173	3.61	-1.89
3201160	0.000	4.683	0.020	0.42	4.672	0.117	2.51	-0.23
3210136	0.000	4.241	0.019	0.45	4.133	0.145	3.52	-2.53
3113336	0.000	4.998	0.023	0.46	4.838	0.116	2.39	-3.20
3105167	0.000	12.657	0.031	0.25	12.656	0.152	1.20	-0.01
3204663	0.000	12.730	0.030	0.24	12.667	0.164	1.30	-0.49
3203030	0.000	12.152	0.022	0.18	12.133	0.123	1.02	-0.16
3206423	0.000	10.825	0.036	0.34	10.201	0.135	1.32	-5.76
3220182	0.000	11.359	0.041	0.36	11.581	0.190	1.64	+1.95
3204609	0.000	10.806	0.029	0.26	10.819	0.123	1.14	+0.13
3217275	0.000	10.487	0.029	0.27	10.517	0.123	1.17	+0.28
3200705	0.000	8.724	0.027	0.31	8.657	0.121	1.40	-0.77
3105315	0.000	9.330	0.029	0.32	9.030	0.120	1.33	-3.21
3204636	0.000	9.403	0.027	0.29	9.201	0.166	1.80	-2.15
3102015	0.000	21.094	0.038	0.18	21.027	0.134	0.64	-0.32
3225453	0.000	24.197	0.044	0.18	24.192	0.138	0.57	-0.02
3213629	0.000	21.984	0.040	0.18	22.044	0.166	0.75	+0.27
3102318	0.000	18.093	0.035	0.20	17.828	0.131	0.73	-1.46
3226636	0.000	20.238	0.027	0.13	20.090	0.126	0.63	-0.73
3201380	0.000	20.200	0.040	0.20	20.184	0.134	0.67	-0.08
3100228	0.000	17.077	0.048	0.28	16.754	0.164	0.98	-1.89
3206762	0.000	15.186	0.028	0.18	15.116	0.129	0.85	-0.46
3106819	0.000	15.451	0.044	0.29	14.926	0.164	1.10	-3.39
3111228	0.000	16.225	0.035	0.21	15.850	0.133	0.84	-2.31
3204654	0.000	14.973	0.035	0.23	14.998	0.128	0.85	+0.17
3207458	0.000	14.459	0.028	0.20	14.319	0.121	0.84	-0.97

Appendix B
Results from ANL-E Destructive Examinations

FOREWORD

Destructive examination data contained in this appendix were transmitted to G. L. Olson (INEEL) from Donald Graczyk (Analytical Chemistry, Chemistry Technology Division, Argonne National Laboratory-East) in a letter dated June 8, 1998 (no letter number). The attachment to this letter is a copy of "Information Package, ANL Destructive Chemical Assay of 33-Rod LWBR EOL Sample" transmitted to Bettis Atomic Power Laboratory on July 31, 1980. This information is available in the INEEL Electronic Records Vault, record number LWBR-0129. Chemist Steve McKinney (INEEL) reviewed the analytical methods used to obtain the data, then entered the data into an electronic format (spreadsheets), which is published here. Steve McKinney prepared the following writeup.

Extensive chemical and physical measurements were performed on 17 LWBR rods. These measurements were subject to the following predefined error requirements and specifications.

Analysis	Percent Relative Bias	Percent Relative Standard Deviation
U-isotopic (U-233 + U-235) (percent abundance)	0.05 (or 0.01 g/U-total per segment) ^a	0.08 (or 0.01 g/U-total per segment) ^a
U-total (g/segment)	0.15	0.15
Cs-137 (atoms/segment)	0.5	1.25
Ce-144 (atoms/segment)	2.0	2.0
Zr-95 (atoms/segment)	2.5 ^b	4.0 ^b
Rod Weight (g) ^c	0.1	0.10
Rod length (in.)	0.001	0.010
Segment weight (g) ^c	0.001 if wt <286 g, otherwise 0.01 g	0.005
Cladding segment length (in.)	0.001	0.005
Fuel segment length (in.)	0.005	0.015
Cladding segment boundary location (in.)	0.010 total	
Fuel segment boundary location (in.)	0.005	0.015

a. The larger of the two shall apply.

b. Waived after 2 years out of the reactor (10/84), for low burnup, or low concentration segments.

c. Weights are given as mass in air relative to 8.0 g/cm³ density standard weights.

d. Not including the average fuel shear-plane displacement, which will be corrected.

Dissolution, Sample Preparation and Sampling

The physical measurements performed on the fuel rods were weight, length, and temperature of the rod surface. The rods were then sheared into predefined lengths (segments) and collected in aluminum buckets. The shearing also served to pulverize the ceramic fuel material, aiding sample dissolution. The segments (and bucket) were then dissolved in one of two high pressure, high temperature dissolver systems. The dissolution was carried out using a 4-hour dissolution in Thorex (13.6 M HNO₃, 0.06 M HF) followed by a dilute nitric acid rinse, then a 3-hour secondary dissolution in a Thorex-0.06 M Al⁺³ solution, followed by a reflux rinse (hot rinse) and cold rinse with dilute nitric acid. Operating conditions for both dissolutions were 195°C and 120 psig. A sample of the second dissolution was obtained to measure the completeness of the dissolution scheme. Both dissolutions and all rinses were then combined in a blend tank and mixed prior to further sampling. Gases emitted during dissolution were collected and analyzed for krypton and xenon.

In all, three sets of samples were obtained from each segment. The first set (two samples) was taken from the secondary dissolution prior to blending to assess the completeness of the dissolution scheme. The second set (four samples) was then taken from the blended (both dissolutions and all rinses)

tank contents. The third set (four samples) was taken after the addition of a known amount of U-238 spike (NBS Standard Sample 950a). Half of the samples were analyzed, and the other half was placed in archive. Batch carryover or cross contamination was controlled and monitored by analyzing a blank (a full dissolution scheme with no segment material) between each rod, and all segments were analyzed in order of increasing uranium content.

Implicit in all measurements is that dissolution is complete, and the fuel in solution is quantitatively transferred to the blend tank.

Uranium Analysis

Total uranium and uranium isotopic (U-233, U-234, U-235, U-236, U-238) analyses were performed by thermal ionization mass spectrometry. Because of the interference of Th-232, U-232 was determined by alpha spectrometry.

Rod B—2606481: The uncertainties for uranium results for segments B-03, B-04, and B-05 may be slightly more than reported due to losses in dissolution (order of 0.01%-0.02%).

Kr/Xe Analysis

Fission gases (krypton and xenon) collected from the fuel rod plenum and during dissolution were determined by gas mass spectrometry on a “best effort” basis. Gases released during shearing were estimated by using the in line radiation monitor in the cell ventilation system. The plenum (rod void volume) contained between 0.01% and 0.15%, and about 0.17% to 0.58% of the gas was released during shearing. The rest (>99%) was released during dissolution.

Rod B—2606481: The total gram weight given in column entitled “gas released in dissolution” is incorrect. The total reflects the 0.0037 contribution of the plenum gases.

Rod C—2513854: The krypton and xenon values for C-04 were estimated using fission gas data from C-03 and C-05 and an assumed correlation with Cs-137 over the three segments.

Cs-137, Ce-144, Nb-95 Analysis

The fission products Cs-137, Ce-144, and Nb-95 were determined by gamma spectrometry (high purity germanium detector with associated automated multi-channel analyzer/data management system) on weighed aliquots of the samples obtained prior to spiking the blend tank with 950a. Cs-137 and Ce-144 were determined on a sample aliquot by direct counting. Zr-95 was obtained after processing the sample aliquot through a cleanup procedure to reduce interferences. The losses of Zr-95 were accounted for by using before and after values of the Ce-144. Error requirements for Zr-95 measurements made after October 1984 were waived because of the short half-life (64.02 days).

Rod "B" 2606481 (PFB III-6 E31)

	B-00	B-01	B-02	B-03	B-04	B-05	B-06
seg length (in) ^a	10.993	10.992	18.091	17.5	17.5	17.497	14.5
total length (in)							
U-232 wt% ^b	0	0.0113	0.0283	0.1091	0.1468	0.1152	0.0
+/- ^b	0	0.0004	0.0009	0.0034	0.0046	0.0036	0.00
U-232 g ⁱ	0.0000E+00	3.2265E-05	3.5353E-03	1.2495E-02	1.6474E-02	1.2847E-02	3.3564E-
+/- ^j	NA	1.1422E-06	1.1243E-04	3.8941E-04	5.1622E-04	4.0147E-04	1.0549E-
Segment Total							
+/- ⁿ							
U-233 wt% ^b	100	99.2297	93.6514	87.8209	85.6132	87.066	92.1
+/- ^b	0	0.021	0.0048	0.0055	0.0061	0.0056	0.00
U-233 g ⁱ	4.0000E-05	2.8333E-01	1.1699E+01	1.0058E+01	9.6073E+00	9.7092E+00	8.8375E+
+/- ^j	1.0000E-05	1.3332E-04	3.2861E-03	2.8971E-03	2.7077E-03	2.7619E-03	2.4345E-
Segment Total							
+/- ⁿ							
U-234 wt% ^b	0	0.7163	5.3256	9.9797	11.6472	10.5888	6.6
+/- ^b	0	0.0006	0.0007	0.0009	0.0011	0.001	0.00
U-234 g ⁱ	0.0000E+00	2.0453E-03	6.6528E-01	1.1429E+00	1.3070E+00	1.1808E+00	6.3301E-
+/- ^j	NA	1.9167E-06	2.0348E-04	3.3747E-04	3.7718E-04	3.4568E-04	1.8367E-
Segment Total							
+/- ⁿ							
U-235 wt% ^b	0	0.0125	0.6384	1.6482	2.0943	1.7634	0.82
+/- ^b	0	0.0149	0.0035	0.0036	0.0037	0.0036	0.00
U-235 g ⁱ	0.0000E+00	3.5691E-05	7.9750E-02	1.8876E-01	2.3502E-01	1.9665E-01	7.8750E-
+/- ^j	NA	4.2544E-05	4.3778E-04	4.1570E-04	4.2012E-04	4.0514E-04	3.5545E-
Segment Total							
+/- ⁿ							
U-236 wt% ^b	0	0.0004	0.081	0.1725	0.2315	0.1902	0.09
+/- ^b	0	0.0002	0.0001	0.0001	0.0001	0.0001	0.00
U-236 g ⁱ	0.0000E+00	1.1421E-06	1.0119E-02	1.9756E-02	2.5978E-02	2.1210E-02	9.4074E-
+/- ^j	NA	5.7106E-07	1.2801E-05	1.2729E-05	1.3271E-05	1.2605E-05	9.9205E-
Segment Total							
+/- ⁿ							

B-5

Rod "B" 2606481 (PFB III-6 E31)

	B-00	B-01	B-02	B-03	B-04	B-05	B-06
seg length (in) ^a	10.993	10.992	18.091	17.5	17.5	17.497	14.5
total length (in)							
U-238 wt% ^b	0	0.0298	0.2752	0.2696	0.2669	0.2764	0.28
+/- ^b	0	0.015	0.0035	0.0036	0.0038	0.0037	0.00
U-238 g ⁱ	0.0000E+00	8.5088E-05	3.4378E-02	3.0876E-02	2.9951E-02	3.0823E-02	2.7589E-0
+/- ^j	NA	4.2830E-05	4.3733E-04	4.1239E-04	4.2651E-04	4.1269E-04	3.5489E-0
Segment Total							
+/- ⁿ							
tot U ^c	0.00004	0.28553	12.49217	11.45266	11.22176	11.15151	9.58
+/- ^c	0.00001	0.00012	0.00345	0.00322	0.00306	0.00309	0.002
Kr-82 (mol%) ^d	0.2	0.2	0.2	0.2	0.2	0.2	0
+/- ^d	0.2	0.2	0.2	0.2	0.2	0.2	0
Kr-82 (g) ^k	1.1468E-06	0.0000E+00	1.8464E-04	3.2681E-04	4.1340E-04	3.3844E-04	1.6291E-0
+/- ^j	1.1468E-06	NA	1.8510E-04	3.2834E-04	4.1461E-04	3.3898E-04	1.6382E-0
Segment Total							
+/- ⁿ							
Kr-83 (mol%) ^d	15.4	15.4	15.4	15.4	15.4	15.4	15
+/- ^d	0.1	0.1	0.1	0.1	0.1	0.1	0
Kr-83 (g) ^k	8.9381E-05	0.0000E+00	1.4391E-02	2.5472E-02	3.2221E-02	2.6378E-02	1.2697E-0
+/- ^j	5.8040E-07	NA	1.0258E-03	2.4700E-03	2.4733E-03	1.5038E-03	1.3433E-0
Segment Total							
+/- ⁿ							
Kr-84 (mol%) ^d	30.1	30.1	30.1	30.1	30.1	30.1	30
+/- ^d	0.3	0.3	0.3	0.3	0.3	0.3	0
Kr-84 (g) ^k	1.7680E-04	0.0000E+00	2.8465E-02	5.0385E-02	6.3734E-02	5.2178E-02	2.5116E-0
+/- ^j	1.7621E-06	NA	2.0404E-03	4.9005E-03	4.9160E-03	3.0007E-03	2.6639E-0
Segment Total							
+/- ⁿ							

B-6

Rod "B" 2606481 (PFB III-6 E31)

	B-00	B-01	B-02	B-03	B-04	B-05	B-06	B-07
seg length (in) ^a	10.993	10.992	18.091	17.5	17.5	17.497	14.562	
total length (in)								
Kr-85 (mol%) ^d	6.2	6.2	6.2	6.2	6.2	6.2	6.2	6.2
+/- ^d	0.1	0.1	0.1	0.1	0.1	0.1	0.1	0.1
Kr-85 (g) ^k	3.6852E-05	0.0000E+00	5.9333E-03	1.0502E-02	1.3285E-02	1.0876E-02	5.2352E-03	2.82
+/- ^j	5.9439E-07	NA	4.3191E-04	1.0301E-03	1.0384E-03	6.4048E-04	5.5921E-04	2.00
Segment Total								
+/- ⁿ								
Kr-86 (mol%) ^d	48.2	48.2	48.2	48.2	48.2	48.2	48.2	48.2
+/- ^d	0.3	0.3	0.3	0.3	0.3	0.3	0.3	0.3
Kr-86 (g) ^k	2.8986E-04	0.0000E+00	4.6669E-02	8.2605E-02	1.0449E-01	8.5545E-02	4.1178E-02	2.22
+/- ^j	1.8041E-06	NA	3.3255E-03	8.0086E-03	8.0186E-03	4.8743E-03	4.3556E-03	1.57
Segment Total								
+/- ⁿ								
Rod Total								
+/- ⁿ								
shear gas (g) ^e	0	0	0.0012	0.003	0.0039	0.0037	0.002	
+/- ^e	NA	NA	0.0002	0.0006	0.0008	0.0008	0.0004	
moles Kr (diss+pl) ^d	0.000007	0	0.001125	0.00199	0.002517	0.00206	0.000991	0.
+/- ^d	0	NA	0.00008	0.000193	0.000193	0.000117	0.000105	0.
Kr+Xe diss&pl (g) ^d	0.0037	0	0.6693	1.2299	1.5355	1.3033	0.5808	
+/- ^d	0.0002	NA	0.0408	0.0544	0.0547	0.0564	0.0168	
moles kr (tot) ^o	7.0000E-06	0	1.1270E-03	1.9949E-03	2.5234E-03	2.0658E-03	9.9441E-04	5.36
+/- ^p	0	NA	8.0001E-05	1.9300E-04	1.9301E-04	1.1701E-04	1.0500E-04	3.80
Xe-128 (mol%) ^d	0.1	0.1	0.1	0.1	0.1	0.1	0.1	0.1
+/- ^d	0	0	0	0	0	0	0	0
Xe-128 (g) ^k	2.9418E-06	0.0000E+00	5.4777E-04	1.0134E-03	1.2628E-03	1.0782E-03	4.7487E-04	1.03
+/- ^j	1.2790E-07	NA	3.8244E-05	4.9246E-05	4.9503E-05	5.2701E-05	1.3434E-05	1.02
SegmentTotal								
+/- ⁿ								

B-7

Rod "B" 2606481 (PFB III-6 E31)

	B-00	B-01	B-02	B-03	B-04	B-05	B-06
seg length (in) ^a	10.993	10.992	18.091	17.5	17.5	17.497	14.5
total length (in)							
Xe-130 (mol%) ^d	0.1	0.1	0.1	0.1	0.1	0.1	0
+/- ^d	0	0	0	0	0	0	
Xe-130 (g) ^k	2.9878E-06	0.0000E+00	5.5633E-04	1.0293E-03	1.2825E-03	1.0951E-03	4.8230E-
+/- ^j	1.2990E-07	NA	3.8842E-05	5.0016E-05	5.0277E-05	5.3525E-05	1.3644E-
SegmentTotal							
+/- ⁿ							
Xe-131 (mol%) ^d	11.9	11.9	11.9	11.9	11.9	11.9	11
+/- ^d	0.1	0.1	0.1	0.1	0.1	0.1	0
Xe-131 (g) ^k	3.5829E-04	0.0000E+00	6.6714E-02	1.2343E-01	1.5380E-01	1.3132E-01	5.7836E-
+/- ^j	1.5866E-05	NA	4.6914E-03	6.0868E-03	6.1661E-03	6.5127E-03	1.7068E-
SegmentTotal							
+/- ⁿ							
Xe-132 (mol%) ^d	22.3	22.3	22.3	22.3	22.3	22.3	22
+/- ^d	0.2	0.2	0.2	0.2	0.2	0.2	0
Xe-132 (g) ^k	6.7654E-04	0.0000E+00	1.2597E-01	2.3306E-01	2.9041E-01	2.4796E-01	1.0921E-
+/- ^j	3.0034E-05	NA	8.8673E-03	1.1517E-02	1.1679E-02	1.2322E-02	3.2410E-
SegmentTotal							
+/- ⁿ							
Xe-134 (mol%) ^d	25.4	25.4	25.4	25.4	25.4	25.4	25
+/- ^d	0.3	0.3	0.3	0.3	0.3	0.3	0
Xe-134 (g) ^k	7.8228E-04	0.0000E+00	1.4566E-01	2.6949E-01	3.3580E-01	2.8672E-01	1.2628E-
+/- ^j	3.5245E-05	NA	1.0314E-02	1.3477E-02	1.3748E-02	1.4417E-02	3.8712E-
SegmentTotal							
+/- ⁿ							

B-8

Rod "B" 2606481 (PFB III-6 E31)

	B-00	B-01	B-02	B-03	B-04	B-05	B-06
seg length (in) ^a	10.993	10.992	18.091	17.5	17.5	17.497	14.562
total length (in)							
Xe-136 (mol%) ^d	40.1	40.1	40.1	40.1	40.1	40.1	40.1
+/- ^d	0.2	0.2	0.2	0.2	0.2	0.2	0.2
Xe-136 (g) ^k	1.2535E-03	0.0000E+00	2.3340E-01	4.3181E-01	5.3807E-01	4.5942E-01	2.0234E-01
+/- ^j	5.4856E-05	NA	1.6337E-02	2.1093E-02	2.1263E-02	2.2572E-02	5.8124E-03
SegmentTotal							
+/- ⁿ							
Rod total							
+/- ⁿ							
shear gas (g) ^e	0	0	0.0012	0.003	0.0039	0.0037	0.002
+/- ^e	0	0	0.0002	0.0006	0.0008	0.0008	0.0004
moles Xe (diss+pl) ^d	0.000023	0	0.004275	0.007904	0.009848	0.008406	0.0037
+/- ^d	0.000001	0	0.000299	0.000385	0.000387	0.000412	0.000105
Kr+Xe diss&pl (g) ^d	0.0037	0	0.6693	1.2299	1.5355	1.3033	0.5808
+/- ^d	0.0002	0	0.0408	0.0544	0.0547	0.0564	0.0168
moles Xe (tot) ^o	2.3000E-05	0	4.2827E-03	7.9233E-03	9.8730E-03	8.4299E-03	3.7127E-03
+/- ^p	1.0000E-06	0	2.9900E-04	3.8502E-04	3.8704E-04	4.1204E-04	1.0503E-04
Values corrected to 1/1/84 (page 181, Final Report for the LWBR Proof of Breeding Analytical Support Project)							
Cs-137 (atoms) ^f	NA	2.7440E+18	6.6220E+20	1.3800E+21	1.6610E+21	1.4600E+21	6.8260E+20
+/- ^f	NA	1.1800E+16	2.7500E+18	5.9300E+18	7.1300E+18	6.2700E+18	2.9300E+18
Cs-137 (g) ^m	NA	6.2375E-04	1.5053E-01	3.1369E-01	3.7757E-01	3.3188E-01	1.5516E-01
+/- ^m	NA	2.6823E-06	6.2511E-04	1.3480E-03	1.6208E-03	1.4253E-03	6.6603E-04
Total							
+/- ⁿ							
Ce-144 (atoms) ^g	NA	3.4950E+17	4.2590E+19	7.0130E+19	8.0720E+19	6.6070E+19	2.5620E+19
+/- ^g	NA	2.5600E+15	3.1700E+17	5.5500E+17	6.5300E+17	5.3600E+17	2.2900E+17
Ce-144 (g) ^m	NA	8.3512E-05	1.0177E-02	1.6757E-02	1.9288E-02	1.5787E-02	6.1218E-03
+/- ^m	NA	6.1171E-07	7.5746E-05	1.3262E-04	1.5603E-04	1.2808E-04	5.4719E-05
Total							
+/- ⁿ							

B-9

Rod "B" 2606481 (PFB III-6 E31)

	B-00	B-01	B-02	B-03	B-04	B-05	B-06
seg length (in) ^a	10.993	10.992	18.091	17.5	17.5	17.497	14.5
total length (in)							
Zr-95 (atoms) ^h	NA	3.8830E+15	3.5110E+17	5.3390E+17	5.8830E+17	3.4900E+17	6.3080E+
+/- ^h	NA	7.9700E+13	4.2500E+15	1.1000E+16	9.7100E+15	7.6500E+15	2.3700E+
Zr-95 (g) ^m	NA	6.1189E-07	5.5327E-05	8.4133E-05	9.2705E-05	5.4996E-05	9.9402E-
+/- ^m	NA	1.2559E-08	6.6972E-07	1.7334E-06	1.5301E-06	1.2055E-06	3.7347E-
Total							
+/- ⁿ							

Footnotes

- a. ANL Destructive Chemical Assay of 33-Rod LWBR EOL Sample - Rod B, 2606481, page 4
- b. ANL Destructive Chemical Assay of 33-Rod LWBR EOL Sample - Rod B, 2606481, page 7
- c. ANL Destructive Chemical Assay of 33-Rod LWBR EOL Sample - Rod B, 2606481, page 8
- d. ANL Destructive Chemical Assay of 33-Rod LWBR EOL Sample - Rod B, 2606481, page 10
- e. ANL Destructive Chemical Assay of 33-Rod LWBR EOL Sample - Rod B, 2606481, page 11
- f. ANL Destructive Chemical Assay of 33-Rod LWBR EOL Sample - Rod B, 2606481, page 12
- g. ANL Destructive Chemical Assay of 33-Rod LWBR EOL Sample - Rod B, 2606481, page 13
- h. ANL Destructive Chemical Assay of 33-Rod LWBR EOL Sample - Rod B, 2606481, page 14
- i. (abundance of the specified isotope)(total weight of uranium) / 100
- j. Error Propagation = $((sd_x/x)^2 + (sd_y/y)^2)^{1/2}(xy)$, where sd is the +/- in the table
- k. (mole%)(number moles gas recovered)(molec wt) / 100
- m. (number of atoms per segment)(atomic weight) / 6.0228E+23
- n. Error Propagation = $(\text{SUM}(sd_i^2))^{1/2}$, where sd is the +/- in the table
- o. ((shear gas / Xe + Kr (diss&pl))(moles Xe or Kr (diss + pl)) + moles Xe or Kr (diss + pl)
- p. Error Propagation = $((((sd_x/x)^2 + (sd_y/y)^2 + (sd_z/z)^2)^{1/2} (xy/z))^2 + (sd_y)^2)^{1/2}$, where sd is the +/- in the table

Rod "C" 2513854 (PFB III-6 F73)

	C-00	C-01	C-02	C-03	C-04	C-05	C-06
seg length (in) ^a	11.146	7.991	17.955	17.498	17.502	17.498	14.53
total length (in)							
U-232 wt% ^b	0	0.0101	0.0208	0.0841	0.114	0.0869	0.024
+/- ^b	0	0.0003	0.0006	0.0026	0.0035	0.0027	0.000
U-232 g ⁱ	0.0000E+00	2.1858E-05	2.6513E-03	9.8567E-03	1.3131E-02	1.0056E-02	2.4883E-0
+/- ^j	NA	6.5052E-07	7.6484E-05	3.0474E-04	4.0315E-04	3.1247E-04	7.9947E-0
Segment Total							
+/- ⁿ							
U-233 wt% ^b	100	99.2944	94.5303	89.6714	87.918	89.3639	93.83
+/- ^b	0	0.0345	0.0047	0.0052	0.0059	0.0055	0.000
U-233 g ⁱ	1.6000E-04	2.1489E-01	1.2050E+01	1.0510E+01	1.0126E+01	1.0342E+01	9.3769E+0
+/- ^j	2.0000E-05	4.0413E-04	3.1951E-03	3.1795E-03	2.8772E-03	2.8686E-03	2.6768E-0
Segment Total							
+/- ⁿ							
U-234 wt% ^b	0	0.6313	4.585	8.5514	9.9101	8.8104	5.19
+/- ^b	0	0.0011	0.001	0.0011	0.0012	0.0012	0.000
U-234 g ⁱ	0.0000E+00	1.3663E-03	5.8444E-01	1.0022E+00	1.1414E+00	1.0196E+00	5.1913E-0
+/- ^j	NA	3.4704E-06	1.9854E-04	3.2431E-04	3.4412E-04	3.0876E-04	1.8108E-0
Segment Total							
+/- ⁿ							
U-235 wt% ^b	0	0.0325	0.5209	1.2935	1.6242	1.3304	0.5
+/- ^b	0	0.0249	0.0034	0.0036	0.004	0.0038	0.000
U-235 g ⁱ	0.0000E+00	7.0337E-05	6.6398E-02	1.5160E-01	1.8708E-01	1.5396E-01	5.9059E-0
+/- ^j	NA	5.3889E-05	4.3374E-04	4.2432E-04	4.6361E-04	4.4172E-04	4.7994E-0
Segment Total							
+/- ⁿ							
U-236 wt% ^b	0	0.0002	0.0744	0.1342	0.17	0.1398	0.080
+/- ^b	0	0.0002	0.0002	0.0002	0.0002	0.0002	0.000
U-236 g ⁱ	0.0000E+00	4.3284E-07	9.4836E-03	1.5729E-02	1.9581E-02	1.6178E-02	8.0344E-0
+/- ^j	NA	4.3284E-07	2.5613E-05	2.3901E-05	2.3662E-05	2.3555E-05	2.0110E-0
Segment Total							
+/- ⁿ							

B-11

Rod "C" 2513854 (PFB III-6 F73)

	C-00	C-01	C-02	C-03	C-04	C-05	C-06
seg length (in) ^a	11.146	7.991	17.955	17.498	17.502	17.498	14.5
total length (in)							
U-238 wt% ^b	0	0.0314	0.2685	0.2655	0.2636	0.2687	0.273
+/- ^b	0	0.0242	0.0033	0.0035	0.0039	0.0037	0.004
U-238 g ^l	0.0000E+00	6.7956E-05	3.4225E-02	3.1117E-02	3.0361E-02	3.1095E-02	2.7361E-0
+/- ^j	NA	5.2374E-05	4.2074E-04	4.1031E-04	4.4928E-04	4.2826E-04	4.5974E-0
Segment Total							
+/- ⁿ							
tot U ^c	0.00016	0.21642	12.74682	11.72025	11.51799	11.57236	9.992
+/- ^c	0.00002	0.0004	0.00332	0.00348	0.00318	0.00313	0.002
Kr-82 (mol%) ^d	0.1	0.1	0.1	0.1	0.1	0.1	0
+/- ^d	0.1	0.1	0.1	0.1	0.1	0.1	0
Kr-82 (g) ^k	3.2765E-07	0.0000E+00	7.7214E-05	1.5535E-04	1.8619E-04	1.6113E-04	6.9034E-0
+/- ^j	3.2765E-07	NA	7.7748E-05	1.5691E-04	1.8836E-04	1.6211E-04	6.9509E-0
Segment Total							
+/- ⁿ							
Kr-83 (mol%) ^d	15.6	15.6	15.6	15.6	15.6	15.6	15
+/- ^d	0.1	0.1	0.1	0.1	0.1	0.1	0
Kr-83 (g) ^k	5.1738E-05	0.0000E+00	1.2193E-02	2.4530E-02	2.9400E-02	2.5443E-02	1.0901E-0
+/- ^j	3.3166E-07	NA	1.4379E-03	3.4959E-03	4.5053E-03	2.8245E-03	1.2824E-0
Segment Total							
+/- ⁿ							
Kr-84 (mol%) ^d	29.9	29.9	29.9	29.9	29.9	29.9	29
+/- ^d	0.2	0.2	0.2	0.2	0.2	0.2	0
Kr-84 (g) ^k	1.0036E-04	0.0000E+00	2.3650E-02	4.7582E-02	5.7028E-02	4.9352E-02	2.1145E-0
+/- ^j	6.7129E-07	NA	2.7894E-03	6.7817E-03	8.7396E-03	5.4796E-03	2.4879E-0
Segment Total							
+/- ⁿ							

B-12

Rod "C" 2513854 (PFB III-6 F73)

	C-00	C-01	C-02	C-03	C-04	C-05	C-06
seg length (in) ^a	11.146	7.991	17.955	17.498	17.502	17.498	14.52
total length (in)							
Kr-85 (mol%) ^d	6	6	6	6	6	6	6
+/- ^d	0.1	0.1	0.1	0.1	0.1	0.1	0
Kr-85 (g) ^k	2.0379E-05	0.0000E+00	4.8025E-03	9.6620E-03	1.1580E-02	1.0021E-02	4.2937E-03
+/- ^j	3.3965E-07	NA	5.7116E-04	1.3850E-03	1.7835E-03	1.1232E-03	5.0944E-04
Segment Total							
+/- ⁿ							
Kr-86 (mol%) ^d	48.5	48.5	48.5	48.5	48.5	48.5	48.5
+/- ^d	0.2	0.2	0.2	0.2	0.2	0.2	0
Kr-86 (g) ^k	1.6667E-04	0.0000E+00	3.9276E-02	7.9019E-02	9.4707E-02	8.1959E-02	3.5116E-02
+/- ^j	6.8728E-07	NA	4.6279E-03	1.1255E-02	1.4505E-02	9.0898E-03	4.1276E-03
Segment Total							
+/- ⁿ							
Rod Total							
+/- ⁿ							
shear gas (g) ^e	0	0	0.001	0.0034	0.0043	0.0037	0.001
+/- ^e	0	0	0.0002	0.0006	0.0009	0.0008	0.0003
moles Kr (diss+pl) ^d	0.000004	0	0.000941	0.001891	0.002266	0.001961	0.00084
+/- ^d	0	0	0.000111	0.00027	0.000348	0.000218	0.00009
Kr+Xe diss&pl (g) ^d	0.0017	0	0.5773	1.1758	1.3996	1.2047	0.569
+/- ^d	0	0	0.0528	0.0761	0.107	0.0755	0.047
moles kr (tot) ^o	4.0000E-06	0	9.4263E-04	1.8965E-03	2.2730E-03	1.9670E-03	8.4277E-04
+/- ^p	0	NA	1.1100E-04	2.7000E-04	3.4801E-04	2.1801E-04	9.9001E-05
Xe-128 (mol%) ^d	0.1	0.1	0.1	0.1	0.1	0.1	0.1
+/- ^d	0.1	0.1	0.1	0.1	0.1	0.1	0
Xe-128 (g) ^k	1.5348E-06	0.0000E+00	4.7496E-04	9.7039E-04	1.1542E-03	9.9250E-04	4.7565E-04
+/- ^j	1.5348E-06	NA	4.7753E-04	9.7284E-04	1.1583E-03	9.9495E-04	4.7770E-04
SegmentTotal							
+/- ⁿ							

Rod "C" 2513854 (PFB III-6 F73)

	C-00	C-01	C-02	C-03	C-04	C-05	C-06
seg length (in) ^a	11.146	7.991	17.955	17.498	17.502	17.498	14.52
total length (in)							
Xe-130 (mol%) ^d	0.1	0.1	0.1	0.1	0.1	0.1	0
+/- ^d	0.1	0.1	0.1	0.1	0.1	0.1	0
Xe-130 (g) ^k	1.5588E-06	0.0000E+00	4.8239E-04	9.8556E-04	1.1722E-03	1.0080E-03	4.8309E-03
+/- ^j	1.5588E-06	NA	4.8500E-04	9.8806E-04	1.1764E-03	1.0105E-03	4.8517E-03
SegmentTotal							
+/- ⁿ							
Xe-131 (mol%) ^d	12.4	12.4	12.4	12.4	12.4	12.4	12
+/- ^d	0.1	0.1	0.1	0.1	0.1	0.1	0
Xe-131 (g) ^k	1.9479E-04	0.0000E+00	6.0277E-02	1.2315E-01	1.4647E-01	1.2596E-01	6.0365E-01
+/- ^j	1.5709E-06	NA	6.3007E-03	8.8218E-03	1.2490E-02	8.9052E-03	5.6375E-02
SegmentTotal							
+/- ⁿ							
Xe-132 (mol%) ^d	22.6	22.6	22.6	22.6	22.6	22.6	22
+/- ^d	0.1	0.1	0.1	0.1	0.1	0.1	0
Xe-132 (g) ^k	3.5772E-04	0.0000E+00	1.1070E-01	2.2617E-01	2.6900E-01	2.3132E-01	1.1086E-01
+/- ^j	1.5828E-06	NA	1.1547E-02	1.6129E-02	2.2867E-02	1.6280E-02	1.0326E-02
SegmentTotal							
+/- ⁿ							
Xe-134 (mol%) ^d	25.9	25.9	25.9	25.9	25.9	25.9	25
+/- ^d	0.2	0.2	0.2	0.2	0.2	0.2	0
Xe-134 (g) ^k	4.1618E-04	0.0000E+00	1.2879E-01	2.6312E-01	3.1295E-01	2.6912E-01	1.2897E-01
+/- ^j	3.2137E-06	NA	1.3459E-02	1.8839E-02	2.6677E-02	1.9016E-02	1.2041E-02
SegmentTotal							
+/- ⁿ							

B-14

Rod "C" 2513854 (PFB III-6 F73)

	C-00	C-01	C-02	C-03	C-04	C-05	C-06
seg length (in) ^a	11.146	7.991	17.955	17.498	17.502	17.498	14.527
total length (in)							
Xe-136 (mol%) ^d	39	39	39	39	39	39	39
+/- ^d	0.1	0.1	0.1	0.1	0.1	0.1	0.1
Xe-136 (g) ^k	6.3605E-04	0.0000E+00	1.9683E-01	4.0213E-01	4.7829E-01	4.1130E-01	1.9711E-01
+/- ^j	1.6309E-06	NA	2.0519E-02	2.8642E-02	4.0621E-02	2.8908E-02	1.8346E-02
SegmentTotal							
+/- ⁿ							
Rod total							
+/- ⁿ							
shear gas (g) ^e	0	0	0.001	0.0034	0.0043	0.0037	0.0012
+/- ^e	0	0	0.0002	0.0006	0.0009	0.0008	0.0002
moles Xe (diss+pl) ^d	0.000012	0	0.003707	0.007565	0.008996	0.007736	0.003711
+/- ^d	0	0	0.000387	0.00054	0.000766	0.000545	0.000346
Kr+Xe diss&pl (g) ^d	0.0017	0	0.5773	1.1758	1.3996	1.2047	0.5694
+/- ^d	0	0	0.0528	0.0761	0.107	0.0755	0.0472
moles Xe (tot) ^o	1.2000E-05	0	3.7134E-03	7.5869E-03	9.0236E-03	7.7598E-03	3.7188E-03
+/- ^p	0.0000E+00	NA	3.8700E-04	5.4002E-04	7.6603E-04	5.4503E-04	3.4600E-04
Values corrected to 1/1/84 (page 181, Final Report for the LWBR Proof of Breeding Analytical Support Project)							
Cs-137 (atoms) ^f	NA	1.8840E+18	5.3660E+20	1.1590E+21	1.3840E+21	1.1950E+21	5.0590E+20
+/- ^f	NA	6.1200E+15	1.4900E+18	3.2200E+18	3.8000E+18	3.3200E+18	1.3900E+18
Cs-137 (g) ^m	NA	4.2826E-04	1.2198E-01	2.6346E-01	3.1460E-01	2.7164E-01	1.1500E-01
+/- ^m	NA	1.3912E-06	3.3870E-04	7.3195E-04	8.6379E-04	7.5468E-04	3.1597E-04
Total							
+/- ⁿ							
Ce-144 (atoms) ^g	NA	2.3460E+17	3.4930E+19	6.0240E+19	6.9510E+19	5.5770E+19	1.9580E+19
+/- ^g	NA	1.3700E+15	1.9700E+17	3.5700E+17	4.0400E+17	3.3100E+17	1.1600E+17
Ce-144 (g) ^m	NA	5.6057E-05	8.3464E-03	1.4394E-02	1.6609E-02	1.3326E-02	4.6786E-03
+/- ^m	NA	3.2736E-07	4.7073E-05	8.5304E-05	9.6535E-05	7.9092E-05	2.7718E-05
Total							
+/- ⁿ							

B-15

Rod "C" 2513854 (PFB III-6 F73)

	C-00	C-01	C-02	C-03	C-04	C-05	C-06
seg length (in) ^a	11.146	7.991	17.955	17.498	17.502	17.498	14.52
total length (in)							
Zr-95 (atoms) ^h	NA	2.6170E+15	2.8670E+17	4.6840E+17	5.0360E+17	3.0430E+17	5.3700E+17
+/- ^h	NA	4.0400E+13	4.5500E+15	8.5600E+15	1.0200E+16	6.0600E+15	1.4800E+16
Zr-95 (g) ^m	NA	4.1239E-07	4.5178E-05	7.3811E-05	7.9358E-05	4.7952E-05	8.4621E-05
+/- ^m	NA	6.3663E-09	7.1699E-07	1.3489E-06	1.6073E-06	9.5494E-07	2.3322E-06
Total							
+/- ⁿ							

Footnotes

- a. ANL Destructive Chemical Assay of 33-Rod LWBR EOL Sample -Rod C, 2513854, page 3
- b. ANL Destructive Chemical Assay of 33-Rod LWBR EOL Sample - Rod C, 2513854, page 6
- c. ANL Destructive Chemical Assay of 33-Rod LWBR EOL Sample - Rod C, 2513854, page 7
- d. ANL Destructive Chemical Assay of 33-Rod LWBR EOL Sample - Rod C, 2513854, page 9
- e. ANL Destructive Chemical Assay of 33-Rod LWBR EOL Sample - Rod C, 2513854, page 10
- f. ANL Destructive Chemical Assay of 33-Rod LWBR EOL Sample - Rod C, 2513854, page 11
- g. ANL Destructive Chemical Assay of 33-Rod LWBR EOL Sample - Rod C, 2513854, page 12
- h. ANL Destructive Chemical Assay of 33-Rod LWBR EOL Sample - Rod C, 2513854, page 13
- i. (abundance of the specified isotope)(total weight of uranium) / 100
- j. Error Propagation = $((sd_x/x)^2 + (sd_y/y)^2)^{1/2} (xy)$, where sd is the +/- in the table
- k. (mole%)(number moles gas recovered)(molec wt) / 100
- m. (number of atoms per segment)(atomic weight) / 6.0228E+23
- n. Error Propagation = $(\text{SUM}(sd_i^2))^{1/2}$, where sd is the +/- in the table
- o. ((shear gas / Xe + Kr (diss&pl))(moles Xe or Kr (diss + pl)) + moles Xe or Kr (diss + pl)
- p. Error Propagation = $(((((sd_x/x)^2 + (sd_y/y)^2 + (sd_z/z)^2)^{1/2} (xy/z))^2 + (sd_y)^2)^{1/2}$, where sd is the +/- in the table

Rod "D" 2502102 (PFB III-6 H1)

	D-00	D-01	D-02	D-03	D-04	D-05	D-06
seg length (in) ^a	11.18	8.063	17.815	17.499	17.502	17.5	14.46
total length (in)							
U-232 wt% ^b	0	0.0049	0.0058	0.0238	0.0336	0.0239	0.006
+/- ^b	0	0.0002	0.0002	0.0007	0.001	0.0007	0.000
U-232 g ⁱ	0.0000E+00	5.3557E-06	7.5157E-04	2.9247E-03	4.0642E-03	2.9273E-03	6.7653E-0
+/- ^j	NA	2.1872E-07	2.5917E-05	8.6026E-05	1.2096E-04	8.5742E-05	2.0817E-0
Segment Total							
+/- ⁿ							
U-233 wt% ^b	100	99.603	96.326	93.932	92.9686	93.9009	96.144
+/- ^b	0	0.1209	0.0056	0.0058	0.0056	0.006	0.006
U-233 g ⁱ	4.0000E-05	1.0887E-01	1.2482E+01	1.1543E+01	1.1245E+01	1.1501E+01	1.0007E+0
+/- ^j	1.0000E-05	1.9946E-04	3.3263E-03	3.3089E-03	3.1600E-03	3.2944E-03	2.7964E-0
Segment Total							
+/- ⁿ							
U-234 wt% ^b	0	0.3175	2.7086	4.8011	5.6131	4.8292	2.866
+/- ^b	0	0.0008	0.0006	0.0007	0.0007	0.0007	0.000
U-234 g ⁱ	0.0000E+00	3.4703E-04	3.5098E-01	5.9000E-01	6.7895E-01	5.9149E-01	2.9831E-0
+/- ^j	NA	9.9569E-07	1.1990E-04	1.8622E-04	2.0469E-04	1.8609E-04	1.0903E-0
Segment Total							
+/- ⁿ							
U-235 wt% ^b	0	0.0042	0.1856	0.4553	0.5872	0.455	0.205
+/- ^b	0	0.0858	0.0048	0.005	0.0048	0.0051	0.005
U-235 g ⁱ	0.0000E+00	4.5906E-06	2.4050E-02	5.5951E-02	7.1026E-02	5.5729E-02	2.1399E-0
+/- ^j	NA	9.3779E-05	6.2202E-04	6.1464E-04	5.8092E-04	6.2485E-04	5.4126E-0
Segment Total							
+/- ⁿ							
U-236 wt% ^b	0	0.0003	0.0162	0.0266	0.0336	0.0266	0.016
+/- ^b	0	0.0003	0.0002	0.0002	0.0002	0.0002	0.000
U-236 g ⁱ	0.0000E+00	3.2790E-07	2.0992E-03	3.2688E-03	4.0642E-03	3.2580E-03	1.7069E-0
+/- ^j	NA	3.2790E-07	2.5922E-05	2.4595E-05	2.4217E-05	2.4513E-05	2.0822E-0
Segment Total							
+/- ⁿ							

B-17

Rod "D" 2502102 (PFB III-6 H1)

	D-00	D-01	D-02	D-03	D-04	D-05	D-06
seg length (in) ^a	11.18	8.063	17.815	17.499	17.502	17.5	14.4
total length (in)							
U-238 wt% ^b	0	0.0701	0.7578	0.7612	0.7639	0.7644	0.7
+/- ^b	0	0.0858	0.0031	0.0035	0.0033	0.0037	0.003
U-238 g ^l	0.0000E+00	7.6619E-05	9.8196E-02	9.3543E-02	9.2399E-02	9.3626E-02	7.9206E-0
+/- ^j	NA	9.3779E-05	4.0251E-04	4.3091E-04	3.9996E-04	4.5394E-04	3.8570E-0
Segment Total							
+/- ⁿ							
tot U ^c	0.00042	0.1093	12.95802	12.28886	12.09575	12.24824	10.408
+/- ^c	0.00002	0.00015	0.00337	0.00344	0.00332	0.00342	0.002
Kr-82 (mol%) ^d	0	0	0	0	0	0	0
+/- ^d	0	0	0	0	0	0	0
Kr-82 (g) ^k	0.0000E+00	0.0000E+00	0.0000E+00	0.0000E+00	0.0000E+00	0.0000E+00	0.0000E+0
+/- ^j	NA	NA	NA	NA	NA	NA	NA
Segment Total							
+/- ⁿ							
Kr-83 (mol%) ^d	16.4	16.4	16.4	16.4	16.4	16.4	16
+/- ^d	0.1	0.1	0.1	0.1	0.1	0.1	0
Kr-83 (g) ^k	0.0000E+00	0.0000E+00	6.0609E-03	1.1997E-02	1.6864E-02	1.3516E-02	5.4763E-0
+/- ^j	NA	NA	1.5098E-03	1.7964E-03	1.4044E-03	1.3487E-03	1.0883E-0
Segment Total							
+/- ⁿ							
Kr-84 (mol%) ^d	29.1	29.1	29.1	29.1	29.1	29.1	29
+/- ^d	0.2	0.2	0.2	0.2	0.2	0.2	0
Kr-84 (g) ^k	0.0000E+00	0.0000E+00	1.0884E-02	2.1543E-02	3.0283E-02	2.4272E-02	9.8339E-0
+/- ^j	NA	NA	2.7115E-03	3.2266E-03	2.5238E-03	2.4232E-03	1.9546E-0
Segment Total							
+/- ⁿ							

B-18

Rod "D" 2502102 (PFB III-6 H1)

	D-00	D-01	D-02	D-03	D-04	D-05	D-06
seg length (in) ^a	11.18	8.063	17.815	17.499	17.502	17.5	14.4
total length (in)							
Kr-85 (mol%) ^d	6.1	6.1	6.1	6.1	6.1	6.1	6
+/- ^d	0.1	0.1	0.1	0.1	0.1	0.1	0
Kr-85 (g) ^k	0.0000E+00	0.0000E+00	2.3087E-03	4.5698E-03	6.4236E-03	5.1485E-03	2.0860E-03
+/- ^j	NA	NA	5.7619E-04	6.8781E-04	5.4382E-04	5.1970E-04	4.1578E-04
Segment Total							
+/- ⁿ							
Kr-86 (mol%) ^d	48.5	48.5	48.5	48.5	48.5	48.5	48
+/- ^d	0.3	0.3	0.3	0.3	0.3	0.3	0
Kr-86 (g) ^k	0.0000E+00	0.0000E+00	1.8572E-02	3.6761E-02	5.1673E-02	4.1416E-02	1.6780E-02
+/- ^j	NA	NA	4.6265E-03	5.5048E-03	4.3037E-03	4.1330E-03	3.3349E-03
Segment Total							
+/- ⁿ							
Rod Total							
+/- ⁿ							
shear gas (g) ^e	0	0	0.0004	0.0015	0.0024	0.0017	0.0004
+/- ^e	0	0.0001	0.0003	0.0003	0.0005	0.0003	0.0001
moles Kr (diss+pl) ^d	0	0	0.000445	0.00088	0.001236	0.000991	0.000445
+/- ^d	0	0	0.000111	0.000132	0.000103	0.000099	0.000099
Kr+Xe diss&pl (g) ^d	0.0003	0	0.2469	0.5823	0.7126	0.5627	0.2222
+/- ^d	0	0	0.0313	0.0543	0.0424	0.0408	0.0222
moles kr (tot) ^o	0.0000E+00	0.0000E+00	4.4572E-04	8.8227E-04	1.2402E-03	9.9399E-04	4.0273E-04
+/- ^p	0	NA	1.1100E-04	1.3200E-04	1.0300E-04	9.9002E-05	8.0000E-05
Xe-128 (mol%) ^d	0	0	0	0	0	0	0
+/- ^d	0	0	0	0	0	0	0
Xe-128 (g) ^k	0.0000E+00	0.0000E+00	0.0000E+00	0.0000E+00	0.0000E+00	0.0000E+00	0.0000E+00
+/- ^j	NA	NA	NA	NA	NA	NA	NA
SegmentTotal							
+/- ⁿ							

Rod "D" 2502102 (PFB III-6 H1)

	D-00	D-01	D-02	D-03	D-04	D-05	D-06
seg length (in) ^a	11.18	8.063	17.815	17.499	17.502	17.5	14.4
total length (in)							
Xe-130 (mol%) ^d	0	0	0	0	0	0	0
+/- ^d	0	0	0	0	0	0	0
Xe-130 (g) ^k	0.0000E+00	0.0000E+00	0.0000E+00	0.0000E+00	0.0000E+00	0.0000E+00	0.0000E+00
+/- ^j	NA	NA	NA	NA	NA	NA	NA
SegmentTotal							
+/- ⁿ							
Xe-131 (mol%) ^d	13.9	13.9	13.9	13.9	13.9	13.9	13.9
+/- ^d	0.1	0.1	0.1	0.1	0.1	0.1	0.1
Xe-131 (g) ^k	3.6392E-05	0.0000E+00	2.8413E-02	6.9030E-02	8.2723E-02	6.5119E-02	2.5411E-01
+/- ^j	2.6181E-07	NA	4.0630E-03	7.2228E-03	5.6543E-03	5.4246E-03	2.9354E-03
SegmentTotal							
+/- ⁿ							
Xe-132 (mol%) ^d	22.3	22.3	22.3	22.3	22.3	22.3	22.3
+/- ^d	0.1	0.1	0.1	0.1	0.1	0.1	0.1
Xe-132 (g) ^k	5.8829E-05	0.0000E+00	4.5932E-02	1.1159E-01	1.3373E-01	1.0527E-01	4.1078E-01
+/- ^j	2.6381E-07	NA	6.5629E-03	1.1659E-02	9.1095E-03	8.7491E-03	4.7397E-03
SegmentTotal							
+/- ⁿ							
Xe-134 (mol%) ^d	27.3	27.3	27.3	27.3	27.3	27.3	27.3
+/- ^d	0.1	0.1	0.1	0.1	0.1	0.1	0.1
Xe-134 (g) ^k	7.3112E-05	0.0000E+00	5.7083E-02	1.3868E-01	1.6619E-01	1.3083E-01	5.1051E-01
+/- ^j	2.6781E-07	NA	8.1550E-03	1.4485E-02	1.1313E-02	1.0868E-02	5.8889E-03
SegmentTotal							
+/- ⁿ							

B-20

Rod "D" 2502102 (PFB III-6 H1)

	D-00	D-01	D-02	D-03	D-04	D-05	D-06	D
seg length (in) ^a	11.18	8.063	17.815	17.499	17.502	17.5	14.464	
total length (in)								
Xe-136 (mol%) ^d	36.5	36.5	36.5	36.5	36.5	36.5	36.5	
+/- ^d	0.1	0.1	0.1	0.1	0.1	0.1	0.1	
Xe-136 (g) ^k	9.9212E-05	0.0000E+00	7.7461E-02	1.8819E-01	2.2552E-01	1.7753E-01	6.9276E-02	
+/- ^j	2.7181E-07	NA	1.1065E-02	1.9651E-02	1.5342E-02	1.4741E-02	7.9894E-03	
SegmentTotal								
+/- ⁿ								
Rod total								
+/- ⁿ								
shear gas (g) ^e	0	0	0.0004	0.0015	0.0024	0.0017	0.0004	
+/- ^e	0	0.0001	0.0003	0.0003	0.0005	0.0003	0.0003	
moles Xe (diss+pl) ^d	0.000002	0	0.001559	0.003784	0.004531	0.003568	0.001394	
+/- ^d	0	0	0.000223	0.000396	0.000309	0.000297	0.000161	
Kr+Xe diss&pl (g) ^d	0.0003	0	0.2469	0.5823	0.7126	0.5627	0.2211	
+/- ^d	0	0	0.0313	0.0543	0.0424	0.0408	0.0226	
moles Xe (tot) ^o	2.0000E-06	0	1.5615E-03	3.7937E-03	4.5463E-03	3.5788E-03	1.3965E-03	
+/- ^p	0.0000E+00	0	2.2301E-04	3.9601E-04	3.0902E-04	2.9701E-04	1.6101E-04	
Values corrected to 1/1/84 (page 181, Final Report for the LWBR Proof of Breeding Analytical Support Project)								
Cs-137 (atoms) ^f	NA	5.3940E+17	2.6590E+20	6.0010E+20	7.3300E+20	6.0410E+20	2.3460E+20	
+/- ^f	NA	2.1500E+15	9.1300E+17	2.0600E+18	2.5800E+18	2.0600E+18	8.0600E+17	
Cs-137 (g) ^m	NA	1.2261E-04	6.0443E-02	1.3641E-01	1.6662E-01	1.3732E-01	5.3328E-02	
+/- ^m	NA	4.8873E-07	2.0754E-04	4.6827E-04	5.8647E-04	4.6827E-04	1.8322E-04	
Total								
+/- ⁿ								
Ce-144 (atoms) ^g	NA	6.6290E+16	1.7390E+19	3.2310E+19	3.8610E+19	2.8740E+19	9.4270E+18	
+/- ^g	NA	3.9800E+14	1.0100E+17	1.9400E+17	2.3100E+17	1.7200E+17	5.6600E+16	
Ce-144 (g) ^m	NA	1.5840E-05	4.1553E-03	7.7204E-03	9.2258E-03	6.8674E-03	2.2526E-03	
+/- ^m	NA	9.5101E-08	2.4134E-05	4.6356E-05	5.5197E-05	4.1099E-05	1.3524E-05	
Total								
+/- ⁿ								

B-21

Rod "D" 2502102 (PFB III-6 H1)

	D-00	D-01	D-02	D-03	D-04	D-05	D-06
seg length (in) ^a	11.18	8.063	17.815	17.499	17.502	17.5	14.4
total length (in)							
Zr-95 (atoms) ^h	NA	6.7580E+14	1.4830E+17	2.6000E+17	2.9880E+17	1.5980E+17	2.8380E+
+/- ^h	NA	1.0800E+13	1.8800E+15	3.4800E+15	4.6900E+15	3.1600E+15	9.5600E+
Zr-95 (g) ^m	NA	1.0649E-07	2.3369E-05	4.0971E-05	4.7085E-05	2.5181E-05	4.4721E-
+/- ^m	NA	1.7019E-09	2.9625E-07	5.4838E-07	7.3906E-07	4.9796E-07	1.5065E-
Total							
+/- ⁿ							

Footnotes

- a. ANL Destructive Chemical Assay of 33-Rod LWBR EOL Sample - Rod D, 2502102, page 3
- b. ANL Destructive Chemical Assay of 33-Rod LWBR EOL Sample - Rod D, 2502102, page 6
- c. ANL Destructive Chemical Assay of 33-Rod LWBR EOL Sample - Rod D, 2502102, page 7
- d. ANL Destructive Chemical Assay of 33-Rod LWBR EOL Sample - Rod D, 2502102, page 9
- e. ANL Destructive Chemical Assay of 33-Rod LWBR EOL Sample - Rod D, 2502102, page 10
- f. ANL Destructive Chemical Assay of 33-Rod LWBR EOL Sample - Rod D, 2502102, page 11
- g. ANL Destructive Chemical Assay of 33-Rod LWBR EOL Sample - Rod D, 2502102, page 12
- h. ANL Destructive Chemical Assay of 33-Rod LWBR EOL Sample - Rod D, 2502102, page 13
- i. (abundance of the specified isotope)(total weight of uranium) / 100
- j. Error Propagation = $((sd_x/x)^2 + (sd_y/y)^2)^{1/2}(xy)$, where sd is the +/- in the table
- k. (mole%)(number moles gas recovered)(molec wt) / 100
- m. (number of atoms per segment)(atomic weight) / 6.0228E+23
- n. Error Propagation = $(\sum(sd_i^2))^{1/2}$, where sd is the +/- in the table
- o. ((shear gas / Xe + Kr (diss&pl))(moles Xe or Kr (diss + pl)) + moles Xe or Kr (diss + pl)
- p. Error Propagation = $((((sd_x/x)^2 + (sd_y/y)^2 + (sd_z/z)^2)^{1/2} (xy/z))^2 + (sd_y)^2)^{1/2}$, where sd is the +/- in the table

Rod "E" 2102187 (PFB III-6 B62)

	E-00	E-01	E-02	E-03	E-04	E-05	E-06
seg length (in) ^a	11.327	8.489	14.129	14	14.101	17.498	17.50
total length (in)							
U-232 wt% ^b	0	0.0116	0.0245	0.0926	0.1448	0.2068	0.14
+/- ^b	0	0.0004	0.0008	0.0029	0.0045	0.0064	0.00
U-232 g ⁱ	0.0000E+00	2.9860E-05	1.6122E-03	6.2204E-03	9.9839E-03	1.1219E-02	6.2710E-0
+/- ^j	NA	1.0297E-06	5.2646E-05	1.9481E-04	3.1029E-04	3.4722E-04	1.9316E-0
Segment Total							
+/- ⁿ							
U-233 wt% ^b	100	99.2317	94.611	90.1459	87.6984	90.8655	93.13
+/- ^b	0	0.0237	0.0076	0.0076	0.0082	0.0079	0.00
U-233 g ⁱ	4.0000E-05	2.5543E-01	6.2259E+00	6.0555E+00	6.0468E+00	4.9295E+00	3.9976E+0
+/- ^j	1.0000E-05	1.1648E-04	1.7115E-03	1.6667E-03	1.7181E-03	1.1970E-03	9.9159E-0
Segment Total							
+/- ⁿ							
U-234 wt% ^b	0	0.7098	4.6147	8.2562	10.1189	7.7469	5.98
+/- ^b	0	0.0004	0.0006	0.0009	0.0012	0.0008	0.00
U-234 g ⁱ	0.0000E+00	1.8271E-03	3.0367E-01	5.5461E-01	6.9770E-01	4.2028E-01	2.5699E-0
+/- ^j	NA	1.2506E-06	8.9064E-05	1.5738E-04	2.0467E-04	1.0471E-04	6.6454E-0
Segment Total							
+/- ⁿ							
U-235 wt% ^b	0	0.0134	0.452	1.1787	1.6747	1.1076	0.69
+/- ^b	0	0.0169	0.0057	0.0058	0.0057	0.0042	0.00
U-235 g ⁱ	0.0000E+00	3.4493E-05	2.9744E-02	7.9179E-02	1.1547E-01	6.0088E-02	2.9806E-0
+/- ^j	NA	4.3502E-05	3.7517E-04	3.9016E-04	3.9423E-04	2.2826E-04	2.4047E-0
Segment Total							
+/- ⁿ							
U-236 wt% ^b	0	0.0003	0.0454	0.0981	0.1511	0.0697	0.03
+/- ^b	0	0.0001	0.0001	0.0001	0.0001	0.0001	0.00
U-236 g ⁱ	0.0000E+00	7.7223E-07	2.9875E-03	6.5898E-03	1.0418E-02	3.7813E-03	1.4551E-0
+/- ^j	NA	2.5741E-07	6.6272E-06	6.9358E-06	7.4401E-06	5.4924E-06	4.3054E-0
Segment Total							
+/- ⁿ							

B-23

Rod "E" 2102187 (PFB III-6 B62)

	E-00	E-01	E-02	E-03	E-04	E-05	E-06
seg length (in) ^a	11.327	8.489	14.129	14	14.101	17.498	17.5
total length (in)							
U-238 wt% ^b	0	0.0332	0.2524	0.2284	0.2122	0.0035	0.00
+/- ^b	0	0.0169	0.0056	0.0055	0.0058	0.0041	0.00
U-238 g ⁱ	0.0000E+00	8.5460E-05	1.6609E-02	1.5343E-02	1.4631E-02	1.8988E-04	1.5881E-
+/- ^j	NA	4.3502E-05	3.6853E-04	3.6948E-04	3.9993E-04	2.2243E-04	2.3608E-
Segment Total							
+/- ⁿ							
tot U ^c	0.0008	0.25741	6.58049	6.71745	6.89499	5.42509	4.292
+/- ^c	0.00002	0.0001	0.00173	0.00176	0.00185	0.00123	0.000
Kr-82 (mol%) ^d	0.1	0.1	0.1	0.1	0.1	0.1	0.1
+/- ^d	0.1	0.1	0.1	0.1	0.1	0.1	0.1
Kr-82 (g) ^k	8.1913E-08	0.0000E+00	4.8389E-05	9.8201E-05	1.3335E-04	8.0324E-05	4.2103E-
+/- ^j	8.1913E-08	0.0000E+00	5.0154E-05	9.9029E-05	1.3401E-04	8.0819E-05	4.2585E-
Segment Total							
+/- ⁿ							
Kr-83 (mol%) ^d	15.6	15.6	15.6	15.6	15.6	15.6	15.6
+/- ^d	0.2	0.2	0.2	0.2	0.2	0.2	0.2
Kr-83 (g) ^k	1.2935E-05	0.0000E+00	7.6408E-03	1.5507E-02	2.1057E-02	1.2684E-02	6.6483E-
+/- ^j	1.6583E-07	0.0000E+00	2.0848E-03	2.0276E-03	2.1128E-03	1.4192E-03	1.0125E-
Segment Total							
+/- ⁿ							
Kr-84 (mol%) ^d	29.7	29.7	29.7	29.7	29.7	29.7	29.7
+/- ^d	0.3	0.3	0.3	0.3	0.3	0.3	0.3
Kr-84 (g) ^k	2.4922E-05	0.0000E+00	1.4722E-02	2.9877E-02	4.0572E-02	2.4438E-02	1.2810E-
+/- ^j	2.5173E-07	0.0000E+00	4.0152E-03	3.8995E-03	4.0581E-03	2.7277E-03	1.9482E-
Segment Total							
+/- ⁿ							

B-24

Rod "E" 2102187 (PFB III-6 B62)

	E-00	E-01	E-02	E-03	E-04	E-05	E-06	E-07
seg length (in) ^a	11.327	8.489	14.129	14	14.101	17.498	17.504	
total length (in)								
Kr-85 (mol%) ^d	6.1	6.1	6.1	6.1	6.1	6.1	6.1	6.1
+/- ^d	0.2	0.2	0.2	0.2	0.2	0.2	0.2	0.2
Kr-85 (g) ^k	5.1797E-06	0.0000E+00	3.0598E-03	6.2096E-03	8.4324E-03	5.0792E-03	2.6623E-03	
+/- ^j	1.6982E-07	0.0000E+00	8.3994E-04	8.3329E-04	8.8349E-04	5.8864E-04	4.1334E-04	
Segment Total								
+/- ⁿ								
Kr-86 (mol%) ^d	48.6	48.6	48.6	48.6	48.6	48.6	48.6	48.6
+/- ^d	0.3	0.3	0.3	0.3	0.3	0.3	0.3	0.3
Kr-86 (g) ^k	4.1753E-05	0.0000E+00	2.4664E-02	5.0055E-02	6.7973E-02	4.0943E-02	2.1460E-02	
+/- ^j	2.5773E-07	0.0000E+00	6.7239E-03	6.5208E-03	6.7770E-03	4.5581E-03	3.2594E-03	
Segment Total								
+/- ⁿ								
Rod Total								
+/- ⁿ								
shear gas (g) ^e	0	0	0.0004	0.0016	0.0023	0.0015	0.0006	
+/- ^e	0	0.0001	0.0001	0.0003	0.0005	0.0003	0.0001	
moles Kr (diss+pl) ^d	0.000001	0	0.00059	0.001196	0.001624	0.000978	0.000513	
+/- ^d	0	0	0.000161	0.000156	0.000162	0.000109	0.000078	
Kr+Xe diss&pl (g) ^d	0.0005	0	0.3238	0.674	0.937	0.5643	0.3104	
+/- ^d	0	0	0.0319	0.0248	0.0322	0.0238	0.0289	
moles kr (tot) ^o	1.0000E-06	0.0000E+00	5.9073E-04	1.1988E-03	1.6280E-03	9.8060E-04	5.1399E-04	
+/- ^p	0	NA	1.6100E-04	1.5600E-04	1.6200E-04	1.0900E-04	7.8000E-05	
Xe-128 (mol%) ^d	0.1	0.1	0.1	0.1	0.1	0.1	0.1	0.1
+/- ^d	0.1	0.1	0.1	0.1	0.1	0.1	0.1	0.1
Xe-128 (g) ^k	3.8371E-07	0.0000E+00	2.6112E-04	5.4680E-04	7.6328E-04	4.5975E-04	2.5476E-04	
+/- ^j	3.8371E-07	NA	2.6256E-04	5.4717E-04	7.6378E-04	4.6023E-04	2.5616E-04	
SegmentTotal								
+/- ⁿ								

B-25

Rod "E" 2102187 (PFB III-6 B62)

	E-00	E-01	E-02	E-03	E-04	E-05	E-06
seg length (in) ^a	11.327	8.489	14.129	14	14.101	17.498	17.50
total length (in)							
Xe-130 (mol%) ^d	0.1	0.1	0.1	0.1	0.1	0.1	0
+/- ^d	0.1	0.1	0.1	0.1	0.1	0.1	0
Xe-130 (g) ^k	3.8971E-07	0.0000E+00	2.6520E-04	5.5535E-04	7.7521E-04	4.6694E-04	2.5875E-04
+/- ^j	3.8971E-07	NA	2.6667E-04	5.5572E-04	7.7573E-04	4.6742E-04	2.6017E-04
SegmentTotal							
+/- ⁿ							
Xe-131 (mol%) ^d	12.1	12.1	12.1	12.1	12.1	12.1	12
+/- ^d	0.1	0.1	0.1	0.1	0.1	0.1	0
Xe-131 (g) ^k	4.7519E-05	0.0000E+00	3.2337E-02	6.7716E-02	9.4524E-02	5.6936E-02	3.1550E-02
+/- ^j	3.9272E-07	NA	3.4160E-03	2.5337E-03	3.5252E-03	2.6246E-03	3.3207E-03
SegmentTotal							
+/- ⁿ							
Xe-132 (mol%) ^d	21.9	21.9	21.9	21.9	21.9	21.9	21
+/- ^d	0.1	0.1	0.1	0.1	0.1	0.1	0
Xe-132 (g) ^k	8.6661E-05	0.0000E+00	5.8973E-02	1.2350E-01	1.7239E-01	1.0384E-01	5.7538E-02
+/- ^j	3.9571E-07	NA	6.2166E-03	4.5419E-03	6.3184E-03	4.7327E-03	6.0431E-03
SegmentTotal							
+/- ⁿ							
Xe-134 (mol%) ^d	25.4	25.4	25.4	25.4	25.4	25.4	25
+/- ^d	0.2	0.2	0.2	0.2	0.2	0.2	0
Xe-134 (g) ^k	1.0204E-04	0.0000E+00	6.9436E-02	1.4541E-01	2.0297E-01	1.2226E-01	6.7746E-02
+/- ^j	8.0343E-07	NA	7.3330E-03	5.4284E-03	7.5525E-03	5.6273E-03	7.1285E-03
SegmentTotal							
+/- ⁿ							

Rod "E" 2102187 (PFB III-6 B62)

	E-00	E-01	E-02	E-03	E-04	E-05	E-06
seg length (in) ^a	11.327	8.489	14.129	14	14.101	17.498	17.504
total length (in)							
Xe-136 (mol%) ^d	40.4	40.4	40.4	40.4	40.4	40.4	40.4
+/- ^d	0.2	0.2	0.2	0.2	0.2	0.2	0.2
Xe-136 (g) ^k	1.6472E-04	0.0000E+00	1.1209E-01	2.3473E-01	3.2766E-01	1.9736E-01	1.0937E-01
+/- ^j	8.1544E-07	NA	1.1818E-02	8.6446E-03	1.2026E-02	9.0036E-03	1.1488E-02
SegmentTotal							
+/- ⁿ							
Rod total							
+/- ⁿ							
shear gas (g) ^e	0	0	0.0004	0.0016	0.0023	0.0015	0.0006
+/- ^e	0	0.0001	0.0001	0.0003	0.0005	0.0003	0.0001
moles Xe (diss+pl) ^d	0.000003	0	0.002039	0.004265	0.005953	0.003585	0.001988
+/- ^d	0	0	0.000215	0.000156	0.000217	0.000163	0.000209
Kr+Xe diss&pl (g) ^d	0.0005	0	0.3238	0.674	0.937	0.5643	0.3104
+/- ^d	0	0	0.0319	0.0248	0.0322	0.0238	0.0289
moles Xe (tot) ^o	3.0000E-06	0	2.0415E-03	4.2751E-03	5.9676E-03	3.5945E-03	1.9918E-03
+/- ^p	0.0000E+00	NA	2.1500E-04	1.5601E-04	2.1702E-04	1.6301E-04	2.0900E-04
Values corrected to 1/1/84 (page 181, Final Report for the LWBR Proof of Breeding Analytical Support Project)							
Cs-137 (atoms) ^f	NA	2.4670E+18	3.0540E+20	6.7250E+20	8.8880E+20	5.2550E+20	3.1760E+20
+/- ^f	NA	9.0570E+15	1.0580E+18	2.3980E+18	3.0740E+18	1.9270E+18	1.1640E+18
Cs-137 (g) ^m	NA	5.6078E-04	6.9422E-02	1.5287E-01	2.0204E-01	1.1945E-01	7.2195E-02
+/- ^m	NA	2.0588E-06	2.4050E-04	5.4510E-04	6.9876E-04	4.3803E-04	2.6459E-04
Total							
+/- ⁿ							
Ce-144 (atoms) ^g	NA	3.1840E+17	2.1360E+19	3.7720E+19	4.6570E+19	3.8390E+19	2.0250E+19
+/- ^g	NA	2.3330E+15	1.5470E+17	2.7950E+17	3.4510E+17	2.8450E+17	1.5000E+17
Ce-144 (g) ^m	NA	7.6081E-05	5.1039E-03	9.0131E-03	1.1128E-02	9.1732E-03	4.8387E-03
+/- ^m	NA	5.5747E-07	3.6965E-05	6.6786E-05	8.2461E-05	6.7981E-05	3.5842E-05
Total							
+/- ⁿ							

B-27

Rod "E" 2102187 (PFB III-6 B62)

	E-00	E-01	E-02	E-03	E-04	E-05	E-06
seg length (in) ^a	11.327	8.489	14.129	14	14.101	17.498	17.504
total length (in)							
Zr-95 (atoms) ^{h,r}	NA	3.4020E+15	1.8000E+17	2.9640E+17	3.5200E+17	2.7990E+17	9.4330E+16
+/- ^{h,r}	NA	4.4230E+13	2.4600E+15	5.8530E+15	9.7460E+15	6.8750E+15	2.6110E+15
Zr-95 (g) ^m	NA	5.3609E-07	2.8365E-05	4.6707E-05	5.5469E-05	4.4107E-05	1.4865E-05
+/- ^m	NA	6.9698E-09	3.8765E-07	9.2232E-07	1.5358E-06	1.0834E-06	4.1144E-07
Total							
+/- ⁿ							

Footnotes

- a. ANL Destructive Chemical Assay of 33-Rod LWBR EOL Sample - Rod E, 2102187, page 3
- b. ANL Destructive Chemical Assay of 33-Rod LWBR EOL Sample - Rod E, 2102187, page 6
- c. ANL Destructive Chemical Assay of 33-Rod LWBR EOL Sample - Rod E, 2102187, page 7
- d. ANL Destructive Chemical Assay of 33-Rod LWBR EOL Sample - Rod E, 2102187, page 10
- e. ANL Destructive Chemical Assay of 33-Rod LWBR EOL Sample - Rod E, 2102187, page 11
- f. ANL Destructive Chemical Assay of 33-Rod LWBR EOL Sample - Rod E, 2102187, page 12
- g. ANL Destructive Chemical Assay of 33-Rod LWBR EOL Sample - Rod E, 2102187, page 13
- h. ANL Destructive Chemical Assay of 33-Rod LWBR EOL Sample - Rod E, 2102187, page 14
- i. (abundance of the specified isotope)(total weight of uranium) / 100
- j. Error Propagation = $((sd_x/x)^2 + (sd_y/y)^2)^{1/2} (xy)$, where sd is the +/- in the table
- k. (mole%)(number moles gas recovered)(molec wt) / 100
- m. (number of atoms per segment)(atomic weight) / 6.0228E+23
- n. Error Propagation = $(\sum(sd_i^2))^{1/2}$, where sd is the +/- in the table
- o. ((shear gas / Xe + Kr (diss&pl))(moles Xe or Kr (diss + pl)) + moles Xe or Kr (diss + pl)
- p. Error Propagation = $(((((sd_x/x)^2 + (sd_y/y)^2 + (sd_z/z)^2)^{1/2} (xy/z))^2 + (sd_y)^2)^{1/2}$, where sd is the +/- in the table
- r. Zr-95 values for segments 5 and 6 corrected per LWBR EOL Sample - Rod E, 2102187, page 14, February 1985

Rod "F" 2400408 (PFB III-6 C13)

	F-00	F-01	F-02	F-03	F-04	F-05	F-06	F-07
seg length (in) ^a	11.283	11.575	14.019	14	14	14.198	14.003	14.003
total length (in)								
U-232 wt% ^b	0	0.0092	0.0134	0.0528	0.0858	0.0907	0.1463	0
+/- ^b	0	0.0003	0.0004	0.0016	0.0027	0.0028	0.0045	0
U-232 g ^j	0.0000E+00	1.9378E-05	1.0351E-03	4.0766E-03	6.6307E-03	6.9198E-03	4.4870E-03	1.167
+/- ^j	NA	6.3197E-07	3.0901E-05	1.2354E-04	2.0867E-04	2.1363E-04	1.3802E-04	3.656
Segment Total								
+/- ⁿ								
U-233 wt% ^b	100	99.4304	95.7489	92.572	90.6675	89.9319	94.6369	96
+/- ^b	0	0.0369	0.0055	0.0067	0.0073	0.0068	0.0083	0
U-233 g ^j	4.0000E-05	2.0943E-01	7.3964E+00	7.1474E+00	7.0069E+00	6.8612E+00	2.9025E+00	1.4704
+/- ^j	1.0000E-05	1.3418E-04	2.1583E-03	2.1911E-03	2.2567E-03	2.1412E-03	8.1671E-04	4.718
Segment Total								
+/- ⁿ								
U-234 wt% ^b	0	0.4954	3.6109	6.2902	7.8107	8.4044	4.7359	3
+/- ^b	0	0.0004	0.0004	0.0007	0.0009	0.0009	0.0006	0
U-234 g ^j	0.0000E+00	1.0435E-03	2.7894E-01	4.8566E-01	6.0362E-01	6.4120E-01	1.4525E-01	4.857
+/- ^j	NA	1.0034E-06	8.5574E-05	1.5444E-04	2.0068E-04	2.0593E-04	4.2974E-05	1.652
Segment Total								
+/- ⁿ								
U-235 wt% ^b	0	0.0153	0.3238	0.7696	1.1037	1.2264	0.4598	0
+/- ^b	0	0.0267	0.0042	0.005	0.0054	0.005	0.0054	0
U-235 g ^j	0.0000E+00	3.2226E-05	2.5013E-02	5.9420E-02	8.5295E-02	9.3567E-02	1.4102E-02	3.249
+/- ^j	NA	5.6238E-05	3.2452E-04	3.8645E-04	4.1817E-04	3.8252E-04	1.6566E-04	1.158
Segment Total								
+/- ⁿ								
U-236 wt% ^b	0	0.0002	0.0391	0.063	0.0882	0.1001	0.0167	0
+/- ^b	0	0.0001	0	0	0	0	0	0
U-236 g ^j	0.0000E+00	4.2126E-07	3.0204E-03	4.8641E-03	6.8162E-03	7.6370E-03	5.1219E-04	8.227
+/- ^j	NA	2.1063E-07	8.6411E-07	1.4490E-06	2.1256E-06	2.3123E-06	1.3694E-07	2.484
Segment Total								
+/- ⁿ								

B-29

Rod "F" 2400408 (PFB III-6 C13)

	F-00	F-01	F-02	F-03	F-04	F-05	F-06	F-07
seg length (in) ^a	11.283	11.575	14.019	14	14	14.198	14.003	14
total length (in)								
U-238 wt% ^b	0	0.0495	0.2638	0.2523	0.2441	0.2466	0.0044	0
+/- ^b	0	0.0258	0.0039	0.0048	0.0052	0.0048	0.0052	0
U-238 g ^l	0.0000E+00	1.0426E-04	2.0378E-02	1.9480E-02	1.8864E-02	1.8814E-02	1.3495E-04	1.081E-02
+/- ^l	NA	5.4343E-05	3.0133E-04	3.7065E-04	4.0191E-04	3.6625E-04	1.5948E-04	1.112E-03
Segment Total								
+/- ⁿ								
tot U ^c	0.00006	0.21063	7.72484	7.72086	7.72813	7.62938	3.06699	1.50000
+/- ^c	0.00001	0.00011	0.00221	0.0023	0.00241	0.00231	0.00082	0.00000
Kr-82 (mol%) ^d	0	0	0	0	0	0	0	0
+/- ^d	0	0	0	0	0	0	0	0
Kr-82 (g) ^k	0.0000E+00	0.0000E+00	0.0000E+00	0.0000E+00	0.0000E+00	0.0000E+00	0.0000E+00	0.0000E+00
+/- ^j	NA	NA	NA	NA	NA	NA	NA	NA
Segment Total								
+/- ⁿ								
Kr-83 (mol%) ^d	15.9	15.9	15.9	15.9	15.9	15.9	15.9	15.9
+/- ^d	0.2	0.2	0.2	0.2	0.2	0.2	0.2	0.2
Kr-83 (g) ^k	1.3183E-05	0.0000E+00	5.6471E-03	1.0908E-02	1.4307E-02	1.7861E-02	3.7483E-03	1.357E-02
+/- ^j	1.6583E-07	NA	6.4988E-04	1.1028E-03	1.4351E-03	1.4414E-03	3.4599E-04	3.958E-04
Segment Total								
+/- ⁿ								
Kr-84 (mol%) ^d	29.3	29.3	29.3	29.3	29.3	29.3	29.3	29.3
+/- ^d	0.2	0.2	0.2	0.2	0.2	0.2	0.2	0.2
Kr-84 (g) ^k	2.4586E-05	0.0000E+00	1.0532E-02	2.0343E-02	2.6682E-02	3.3309E-02	6.9904E-03	2.532E-02
+/- ^j	1.6782E-07	NA	1.2069E-03	2.0454E-03	2.6616E-03	2.6650E-03	6.4102E-04	7.377E-04
Segment Total								
+/- ⁿ								

B-30

Rod "F" 2400408 (PFB III-6 C13)

	F-00	F-01	F-02	F-03	F-04	F-05	F-06	F-07
seg length (in) ^a	11.283	11.575	14.019	14	14	14.198	14.003	10.
total length (in)								
Kr-85 (mol%) ^d	6	6	6	6	6	6	6	
+/- ^d	0.1	0.1	0.1	0.1	0.1	0.1	0.1	
Kr-85 (g) ^k	5.0947E-06	0.0000E+00	2.1823E-03	4.2155E-03	5.5291E-03	6.9024E-03	1.4486E-03	5.2476E-03
+/- ^j	8.4912E-08	NA	2.5228E-04	4.2866E-04	5.5790E-04	5.6214E-04	1.3465E-04	1.5309E-04
Segment Total								
+/- ⁿ								
Kr-86 (mol%) ^d	48.8	48.8	48.8	48.8	48.8	48.8	48.8	48.8
+/- ^d	0.2	0.2	0.2	0.2	0.2	0.2	0.2	0.2
Kr-86 (g) ^k	4.1924E-05	0.0000E+00	1.7958E-02	3.4689E-02	4.5498E-02	5.6799E-02	1.1920E-02	4.3182E-02
+/- ^j	1.7182E-07	NA	2.0556E-03	3.4827E-03	4.5317E-03	4.5339E-03	1.0911E-03	1.2579E-03
Segment Total								
+/- ⁿ								
Rod Total								
+/- ⁿ								
shear gas (g) ^e	0	0	0.0002	0.0009	0.0014	0.0017	0.0002	
+/- ^e	0	0	0	0.0002	0.0003	0.0003	0	
moles Kr (diss+pl) ^d	0.000001	0	0.000428	0.000826	0.001083	0.001352	0.000284	0.000284
+/- ^d	0	0	0.000049	0.000083	0.000108	0.000108	0.000026	0.000026
Kr+Xe diss&pl (g) ^d	0.0005	0	0.2427	0.5243	0.6734	0.819	0.1758	0.000284
+/- ^d	0	0	0.0085	0.0449	0.0446	0.0375	0.0118	0.000284
moles kr (tot) ^o	1.0000E-06	0	4.2835E-04	8.2742E-04	1.0853E-03	1.3548E-03	2.8432E-04	1.0300E-03
+/- ^p	0.0000E+00	NA	4.9000E-05	8.3001E-05	1.0800E-04	1.0800E-04	2.6000E-05	3.0000E-05
Xe-128 (mol%) ^d	0	0	0	0	0	0	0	0
+/- ^d	0	0	0	0	0	0	0	0
Xe-128 (g) ^k	0.0000E+00	0.0000E+00	0.0000E+00	0.0000E+00	0.0000E+00	0.0000E+00	0.0000E+00	0.0000E+00
+/- ^j	NA	NA	NA	NA	NA	NA	NA	NA
SegmentTotal								
+/- ⁿ								

B-31

Rod "F" 2400408 (PFB III-6 C13)

	F-00	F-01	F-02	F-03	F-04	F-05	F-06	F-07
seg length (in) ^a	11.283	11.575	14.019	14	14	14.198	14.003	14
total length (in)								
Xe-130 (mol%) ^d	0	0	0	0	0	0	0	0
+/- ^d	0	0	0	0	0	0	0	0
Xe-130 (g) ^k	0.0000E+00	0.0000E+00	0.0000E+00	0.0000E+00	0.0000E+00	0.0000E+00	0.0000E+00	0.0000E+00
+/- ^j	NA	NA	NA	NA	NA	NA	NA	NA
SegmentTotal								
+/- ⁿ								
Xe-131 (mol%) ^d	12.9	12.9	12.9	12.9	12.9	12.9	12.9	12.9
+/- ^d	0.1	0.1	0.1	0.1	0.1	0.1	0.1	0.1
Xe-131 (g) ^k	5.0660E-05	0.0000E+00	2.5976E-02	5.7260E-02	7.3322E-02	8.8789E-02	1.9121E-02	5.7750E-02
+/- ^j	3.9272E-07	NA	9.5035E-04	5.5903E-03	5.5177E-03	4.6112E-03	1.4598E-03	1.2840E-03
SegmentTotal								
+/- ⁿ								
Xe-132 (mol%) ^d	22.1	22.1	22.1	22.1	22.1	22.1	22.1	22.1
+/- ^d	0.2	0.2	0.2	0.2	0.2	0.2	0.2	0.2
Xe-132 (g) ^k	8.7452E-05	0.0000E+00	4.4842E-02	9.8845E-02	1.2657E-01	1.5327E-01	3.3007E-02	9.9690E-02
+/- ^j	7.9142E-07	NA	1.6539E-03	9.6614E-03	9.5432E-03	7.9922E-03	2.5247E-03	2.2170E-03
SegmentTotal								
+/- ⁿ								
Xe-134 (mol%) ^d	26.2	26.2	26.2	26.2	26.2	26.2	26.2	26.2
+/- ^d	0.1	0.1	0.1	0.1	0.1	0.1	0.1	0.1
Xe-134 (g) ^k	1.0525E-04	0.0000E+00	5.3967E-02	1.1896E-01	1.5233E-01	1.8446E-01	3.9724E-02	1.1990E-01
+/- ^j	4.0172E-07	NA	1.9405E-03	1.1586E-02	1.1417E-02	9.4989E-03	3.0210E-03	2.6660E-03
SegmentTotal								
+/- ⁿ								

Rod "F" 2400408 (PFB III-6 C13)

	F-00	F-01	F-02	F-03	F-04	F-05	F-06	F-07
seg length (in) ^a	11.283	11.575	14.019	14	14	14.198	14.003	14
total length (in)								
Xe-136 (mol%) ^d	38.8	38.8	38.8	38.8	38.8	38.8	38.8	38.8
+/- ^d	0.2	0.2	0.2	0.2	0.2	0.2	0.2	0.2
Xe-136 (g) ^k	1.5820E-04	0.0000E+00	8.1116E-02	1.7880E-01	2.2896E-01	2.7726E-01	5.9708E-02	1.8034E-01
+/- ^j	8.1544E-07	NA	2.9302E-03	1.7426E-02	1.7179E-02	1.4310E-02	4.5454E-03	4.0081E-02
SegmentTotal								
+/- ⁿ								
Rod total								
+/- ⁿ								
shear gas (g) ^e	0	0	0.0002	0.0009	0.0014	0.0017	0.0002	0
+/- ^e	0	0	0	0.0002	0.0003	0.0003	0	0
moles Xe (diss+pl) ^d	0.000003	0	0.001537	0.003385	0.004333	0.005247	0.001131	0.002000
+/- ^d	0	0	0.000055	0.00033	0.000325	0.00027	0.000086	0.000000
Kr+Xe diss&pl (g) ^d	0.0005	0	0.2427	0.5243	0.6734	0.819	0.1758	0
+/- ^d	0	0	0.0085	0.0449	0.0446	0.0375	0.0118	0
moles Xe (tot) ^o	3.0000E-06	0	1.5383E-03	3.3908E-03	4.3420E-03	5.2579E-03	1.1323E-03	3.4200E-03
+/- ^p	0.0000E+00	0	5.5000E-05	3.3000E-04	3.2501E-04	2.7001E-04	8.6000E-05	7.6000E-05
Values corrected to 1/1/84 (page 181, Final Report for the LWBR Proof of Breeding Analytical Support Project)								
Cs-137 (atoms) ^f	NA	1.5000E+18	2.3740E+20	5.2670E+20	6.9990E+20	7.7010E+20	1.7460E+20	5.8670E+19
+/- ^f	NA	5.0790E+15	8.0300E+17	1.7800E+18	2.2890E+18	2.4290E+18	5.9030E+17	1.9210E+17
Cs-137 (g) ^m	NA	3.4097E-04	5.3964E-02	1.1973E-01	1.5910E-01	1.7505E-01	3.9689E-02	1.3334E-01
+/- ^m	NA	1.1545E-06	1.8253E-04	4.0462E-04	5.2032E-04	5.5215E-04	1.3418E-04	4.3661E-04
Total								
+/- ⁿ								
Ce-144 (atoms) ^g	NA	1.9660E+17	1.6810E+19	2.9810E+19	3.7130E+19	3.9680E+19	1.2010E+19	3.4880E+18
+/- ^g	NA	1.3690E+15	1.1710E+17	2.1490E+17	2.6320E+17	2.7630E+17	8.5140E+16	2.3980E+16
Ce-144 (g) ^m	NA	4.6977E-05	4.0167E-03	7.1230E-03	8.8721E-03	9.4814E-03	2.8698E-03	8.3344E-03
+/- ^m	NA	3.2712E-07	2.7981E-05	5.1350E-05	6.2891E-05	6.6021E-05	2.0344E-05	5.7300E-05
Total								
+/- ⁿ								

B-33

Rod "F" 2400408 (PFB III-6 C13)

	F-00	F-01	F-02	F-03	F-04	F-05	F-06	F-07
seg length (in) ^a	11.283	11.575	14.019	14	14	14.198	14.003	
total length (in)								
Zr-95 (atoms) ^h	NA	1.9980E+15	1.4220E+17	2.5240E+17	2.7950E+17	2.8920E+17	6.9420E+16	1.10
+/- ⁿ	NA	3.9780E+13	2.0000E+15	7.2930E+15	9.0260E+15	9.3340E+15	2.8510E+15	3.03
Zr-95 (g) ^m	NA	3.1485E-07	2.2408E-05	3.9773E-05	4.4044E-05	4.5572E-05	1.0939E-05	1.74
+/- ^m	NA	6.2686E-09	3.1516E-07	1.1492E-06	1.4223E-06	1.4709E-06	4.4926E-07	4.77
Total								
+/- ⁿ								

Footnotes

- a. ANL Destructive Chemical Assay of 33-Rod LWBR EOL Sample - Rod F, 2400408, page 3
- b. ANL Destructive Chemical Assay of 33-Rod LWBR EOL Sample - Rod F, 2400408, page 6
- c. ANL Destructive Chemical Assay of 33-Rod LWBR EOL Sample - Rod F, 2400408, page 7
- d. ANL Destructive Chemical Assay of 33-Rod LWBR EOL Sample - Rod F, 2400408, page 10
- e. ANL Destructive Chemical Assay of 33-Rod LWBR EOL Sample - Rod F, 2400408, page 11
- f. ANL Destructive Chemical Assay of 33-Rod LWBR EOL Sample - Rod F, 2400408, page 12
- g. ANL Destructive Chemical Assay of 33-Rod LWBR EOL Sample - Rod F, 2400408, page 13
- h. ANL Destructive Chemical Assay of 33-Rod LWBR EOL Sample - Rod F, 2400408, page 14
- i. (abundance of the specified isotope)(total weight of uranium) / 100
- j. Error Propagation = $((sd_x/x)^2 + (sd_y/y)^2)^{1/2}(xy)$, where sd is the +/- in the table
- k. (mole%)(number moles gas recovered)(molec wt) / 100
- m. (number of atoms per segment)(atomic weight) / 6.0228E+23
- n. Error Propagation = $(SUM(sd_i^2))^{1/2}$, where sd is the +/- in the table
- o. $((shear\ gas / Xe + Kr\ (diss\ \&\ pl)))(moles\ Xe\ or\ Kr\ (diss\ +\ pl)) + moles\ Xe\ or\ Kr\ (diss\ +\ pl)$
- p. Error Propagation = $(((((sd_x/x)^2 + (sd_y/y)^2 + (sd_z/z)^2)^{1/2} (xy/z))^2 + (sd_y)^2)^{1/2}$, where sd is the +/- in the table

Rod "G" 2300711 (PFB III-6 D29)

	G-00	G-01	G-02	G-03	G-04	G-05	G-06
seg length (in) ^a	11.163	8.374	17.971	17.501	17.499	17.601	10.499
total length (in)							
U-232 wt% ^b	0	0.0134	0.0281	0.1073	0.1403	0.1134	0.1209
+/- ^b	0	0.0004	0.0009	0.0033	0.0043	0.0035	0.0038
U-232 g ⁱ	0.0000E+00	3.6948E-05	3.5407E-03	1.2369E-02	1.5820E-02	1.2608E-02	2.5015E-03
+/- ^j	NA	1.1030E-06	1.1341E-04	3.8043E-04	4.8487E-04	3.8914E-04	7.8625E-05
Segment Total							
+/- ⁿ							
U-233 wt% ^b	100	99.1676	93.7298	88.0241	85.7769	86.8602	94.9615
+/- ^b	0	0.0154	0.0041	0.005	0.0053	0.005	0.0103
U-233 g ⁱ	4.0000E-05	2.7343E-01	1.1810E+01	1.0147E+01	9.6719E+00	9.6571E+00	1.9648E+00
+/- ^j	1.0000E-05	1.0788E-04	2.9697E-03	2.5569E-03	2.3669E-03	2.5541E-03	5.1179E-04
Segment Total							
+/- ⁿ							
U-234 wt% ^b	0	0.7748	5.2705	9.8282	11.5306	10.7444	4.4859
+/- ^b	0	0.0005	0.0006	0.0009	0.001	0.0009	0.0008
U-234 g ⁱ	0.0000E+00	2.1364E-03	6.6410E-01	1.1330E+00	1.3001E+00	1.1946E+00	9.2815E-02
+/- ^j	NA	1.5815E-06	1.8099E-04	2.9686E-04	3.2787E-04	3.2419E-04	2.7516E-05
Segment Total							
+/- ⁿ							
U-235 wt% ^b	0	0.0138	0.6276	1.6139	2.0687	1.8205	0.4116
+/- ^b	0	0.0109	0.003	0.0031	0.003	0.0031	0.0071
U-235 g ⁱ	0.0000E+00	3.8051E-05	7.9080E-02	1.8605E-01	2.3326E-01	2.0240E-01	8.5161E-03
+/- ^j	NA	3.0055E-05	3.7852E-04	3.6027E-04	3.4275E-04	3.4860E-04	1.4691E-04
Segment Total							
+/- ⁿ							
U-236 wt% ^b	0	0.0001	0.0774	0.1652	0.2243	0.1927	0.0148
+/- ^b	0	0.0001	0.0001	0.0001	0.0001	0.0001	0.0001
U-236 g ⁱ	0.0000E+00	2.7573E-07	9.7527E-03	1.9044E-02	2.5291E-02	2.1424E-02	3.0622E-04
+/- ^j	NA	2.7573E-07	1.2830E-05	1.2440E-05	1.2767E-05	1.2418E-05	2.0703E-06
Segment Total							
+/- ⁿ							

B-35

Rod "G" 2300711 (PFB III-6 D29)

	G-00	G-01	G-02	G-03	G-04	G-05	G-06
seg length (in) ^a	11.163	8.374	17.971	17.501	17.499	17.601	10.4
total length (in)							
U-238 wt% ^b	0	0.0303	0.2667	0.2613	0.2592	0.2689	0.00
+/- ^b	0	0.011	0.003	0.0032	0.0031	0.0032	0.00
U-238 g ⁱ	0.0000E+00	8.3546E-05	3.3605E-02	3.0122E-02	2.9226E-02	2.9896E-02	1.1173E
+/- ^j	NA	3.0330E-05	3.7810E-04	3.6896E-04	3.4961E-04	3.5586E-04	1.5104E
Segment Total							
+/- ⁿ							
tot U ^c	0.00011	0.27573	12.60037	11.52779	11.27561	11.11803	2.069
+/- ^c	0.00001	0.0001	0.00312	0.00283	0.00267	0.00287	0.00
Kr-82 (mol%) ^d	0.1	0.1	0.1	0.1	0.1	0.1	
+/- ^d	0	0	0	0	0	0	
Kr-82 (g) ^k	4.0957E-07	0.0000E+00	1.0021E-04	1.7297E-04	2.1641E-04	1.8871E-04	1.4863E
+/- ^j	0.0000E+00	NA	1.8135E-05	1.8038E-05	2.0476E-05	2.0229E-05	2.9419E
Segment Total							
+/- ⁿ							
Kr-83 (mol%) ^d	15.6	15.6	15.6	15.6	15.6	15.6	1
+/- ^d	0.1	0.1	0.1	0.1	0.1	0.1	
Kr-83 (g) ^k	6.4673E-05	0.0000E+00	1.5824E-02	2.7313E-02	3.4173E-02	2.9799E-02	2.3469E
+/- ^j	4.1457E-07	NA	2.8733E-03	2.8640E-03	3.2542E-03	3.2136E-03	4.6593E
Segment Total							
+/- ⁿ							
Kr-84 (mol%) ^d	29.9	29.9	29.9	29.9	29.9	29.9	2
+/- ^d	0.2	0.2	0.2	0.2	0.2	0.2	
Kr-84 (g) ^k	1.2545E-04	0.0000E+00	3.0693E-02	5.2980E-02	6.6286E-02	5.7801E-02	4.5524E
+/- ^j	8.3912E-07	NA	5.5737E-03	5.5563E-03	6.3134E-03	6.2345E-03	9.0381E
Segment Total							
+/- ⁿ							

Rod "G" 2300711 (PFB III-6 D29)

	G-00	G-01	G-02	G-03	G-04	G-05	G-06
seg length (in) ^a	11.163	8.374	17.971	17.501	17.499	17.601	10.49
total length (in)							
Kr-85 (mol%) ^d	5.9	5.9	5.9	5.9	5.9	5.9	5.9
+/- ^d	0.1	0.1	0.1	0.1	0.1	0.1	0.1
Kr-85 (g) ^k	2.5049E-05	0.0000E+00	6.1288E-03	1.0579E-02	1.3236E-02	1.1542E-02	9.0901E-03
+/- ^j	4.2456E-07	NA	1.1170E-03	1.1216E-03	1.2774E-03	1.2578E-03	1.8103E-03
Segment Total							
+/- ⁿ							
Kr-86 (mol%) ^d	48.7	48.7	48.7	48.7	48.7	48.7	48.7
+/- ^d	0.2	0.2	0.2	0.2	0.2	0.2	0.2
Kr-86 (g) ^k	2.0919E-04	0.0000E+00	5.1183E-02	8.8348E-02	1.1054E-01	9.6387E-02	7.5914E-02
+/- ^j	8.5911E-07	NA	9.2906E-03	9.2538E-03	1.0512E-02	1.0384E-02	1.5066E-02
Segment Total							
+/- ⁿ							
Rod Total							
+/- ⁿ							
shear gas (g) ^e	0	0	0.0018	0.0047	0.0062	0.0058	0.0000
+/- ^e	0	0.0003	0.0004	0.0009	0.0012	0.0012	0.0000
moles Kr (diss+pl) ^d	0.000005	0	0.00122	0.002104	0.002631	0.002294	0.00018
+/- ^d	0	0	0.000222	0.000221	0.000251	0.000248	0.00003
Kr+Xe diss&pl (g) ^d	0.003	0	0.6543	1.2938	1.4851	1.3601	0.122
+/- ^d	0.0001	0	0.0554	0.1499	0.1696	0.1678	0.019
moles kr (tot) ^o	5.0000E-06	0	1.2234E-03	2.1116E-03	2.6420E-03	2.3038E-03	1.8144E-03
+/- ^p	0.0000E+00	0.0000E+00	2.2200E-04	2.2101E-04	2.5101E-04	2.4801E-04	3.6003E-04
Xe-128 (mol%) ^d	0.1	0.1	0.1	0.1	0.1	0.1	0.1
+/- ^d	0	0	0	0	0	0	0
Xe-128 (g) ^k	2.4302E-06	0.0000E+00	5.2610E-04	1.0664E-03	1.2071E-03	1.1151E-03	1.0206E-03
+/- ^j	1.2790E-07	NA	4.9628E-05	1.4172E-04	1.6027E-04	1.5861E-04	1.8548E-04
SegmentTotal							
+/- ⁿ							

B-37

Rod "G" 2300711 (PFB III-6 D29)

	G-00	G-01	G-02	G-03	G-04	G-05	G-06
seg length (in) ^a	11.163	8.374	17.971	17.501	17.499	17.601	10.4
total length (in)							
Xe-130 (mol%) ^d	0.1	0.1	0.1	0.1	0.1	0.1	0
+/- ^d	0	0	0	0	0	0	0
Xe-130 (g) ^k	2.4682E-06	0.0000E+00	5.3433E-04	1.0830E-03	1.2259E-03	1.1325E-03	1.0366E-0
+/- ^j	1.2990E-07	NA	5.0404E-05	1.4394E-04	1.6277E-04	1.6109E-04	1.8838E-0
SegmentTotal							
+/- ⁿ							
Xe-131 (mol%) ^d	11.7	11.7	11.7	11.7	11.7	11.7	11
+/- ^d	0.1	0.1	0.1	0.1	0.1	0.1	0
Xe-131 (g) ^k	2.9100E-04	0.0000E+00	6.2999E-02	1.2769E-01	1.4454E-01	1.3352E-01	1.2221E-0
+/- ^j	1.5517E-05	NA	5.9671E-03	1.7005E-02	1.9231E-02	1.9027E-02	2.2235E-0
SegmentTotal							
+/- ⁿ							
Xe-132 (mol%) ^d	22.4	22.4	22.4	22.4	22.4	22.4	22
+/- ^d	0.1	0.1	0.1	0.1	0.1	0.1	0
Xe-132 (g) ^k	5.6138E-04	0.0000E+00	1.2153E-01	2.4633E-01	2.7884E-01	2.5759E-01	2.3577E-0
+/- ^j	2.9653E-05	NA	1.1477E-02	3.2757E-02	3.7044E-02	3.6657E-02	4.2860E-0
SegmentTotal							
+/- ⁿ							
Xe-134 (mol%) ^d	25.4	25.4	25.4	25.4	25.4	25.4	25
+/- ^d	0.1	0.1	0.1	0.1	0.1	0.1	0
Xe-134 (g) ^k	6.4623E-04	0.0000E+00	1.3990E-01	2.8356E-01	3.2098E-01	2.9652E-01	2.7140E-0
+/- ^j	3.4107E-05	NA	1.3208E-02	3.7703E-02	4.2637E-02	4.2192E-02	4.9334E-0
SegmentTotal							
+/- ⁿ							

B-38

Rod "G" 2300711 (PFB III-6 D29)

	G-00	G-01	G-02	G-03	G-04	G-05	G-06	G-07
seg length (in) ^a	11.163	8.374	17.971	17.501	17.499	17.601	10.499	
total length (in)								
Xe-136 (mol%) ^d	40.3	40.3	40.3	40.3	40.3	40.3	40.3	40.3
+/- ^d	0.1	0.1	0.1	0.1	0.1	0.1	0.1	0.1
Xe-136 (g) ^k	1.0406E-03	0.0000E+00	2.2529E-01	4.5663E-01	5.1688E-01	4.7749E-01	4.3704E-02	
+/- ^j	5.4831E-05	NA	2.1259E-02	6.0698E-02	6.8642E-02	6.7928E-02	7.9432E-03	
SegmentTotal								
+/- ⁿ								
Rod total								
+/- ⁿ								
shear gas (g) ^e	0	0	0.0018	0.0047	0.0062	0.0058	0.0003	
+/- ^e	0	0.0003	0.0004	0.0009	0.0012	0.0012	0.0003	
moles Xe (diss+pl) ^d	0.000019	0	0.004102	0.008307	0.009398	0.008681	0.000796	
+/- ^d	0.000001	0	0.000388	0.001108	0.001253	0.00124	0.000145	
Kr+Xe diss&pl (g) ^d	0.003	0	0.6543	1.2938	1.4851	1.3601	0.1222	
+/- ^d	0.0001	0	0.0554	0.1499	0.1696	0.1678	0.0197	
moles Xe (tot) ^o	1.9000E-05	0	4.1133E-03	8.3372E-03	9.4372E-03	8.7180E-03	7.9795E-04	
+/- ^p	1.0000E-06	0.0000E+00	3.8801E-04	1.1080E-03	1.2530E-03	1.2400E-03	1.4501E-04	
Values corrected to 1/1/84 (page 181, Final Report for the LWBR Proof of Breeding Analytical Support Project)								
Cs-137 (atoms) ^f	NA	2.8440E+18	6.5460E+20	1.3660E+21	1.6500E+21	1.4930E+21	1.1120E+20	
+/- ^f	NA	9.8480E+15	1.9110E+18	3.9930E+18	4.8160E+18	4.5460E+18	3.7420E+17	
Cs-137 (g) ^m	NA	6.4648E-04	1.4880E-01	3.1051E-01	3.7507E-01	3.3938E-01	2.5277E-02	
+/- ^m	NA	2.2386E-06	4.3440E-04	9.0767E-04	1.0947E-03	1.0334E-03	8.5061E-05	
Total								
+/- ⁿ								
Ce-144 (atoms) ^g	NA	3.5770E+17	4.1750E+19	6.8620E+19	7.9890E+19	6.5190E+19	6.4820E+18	
+/- ^g	NA	2.1040E+15	2.3860E+17	3.9230E+17	4.5650E+17	3.8240E+17	4.0190E+16	
Ce-144 (g) ^m	NA	8.5472E-05	9.9761E-03	1.6397E-02	1.9090E-02	1.5577E-02	1.5489E-03	
+/- ^m	NA	5.0275E-07	5.7013E-05	9.3739E-05	1.0908E-04	9.1374E-05	9.6033E-06	
Total								
+/- ⁿ								

B-39

Rod "G" 2300711 (PFB III-6 D29)

	G-00	G-01	G-02	G-03	G-04	G-05	G-06	G-07
seg length (in) ^a	11.163	8.374	17.971	17.501	17.499	17.601	10.499	
total length (in)								
Zr-95 (atoms) ^h	NA	3.8060E+15	3.5190E+17	5.4050E+17	5.7580E+17	3.5670E+17	2.0890E+16	
+/- ^h	NA	9.7270E+13	9.3530E+15	1.7500E+16	1.5930E+16	1.4870E+16	8.6540E+14	
Zr-95 (g) ^m	NA	5.9975E-07	5.5453E-05	8.5173E-05	9.0735E-05	5.6209E-05	3.2919E-06	
+/- ^m	NA	1.5328E-08	1.4739E-06	2.7577E-06	2.5103E-06	2.3432E-06	1.3637E-07	
Total								
+/- ⁿ								

Footnotes

- a. ANL Destructive Chemical Assay of 33-Rod LWBR EOL Sample - Rod G, 2300711, page 3
- b. ANL Destructive Chemical Assay of 33-Rod LWBR EOL Sample - Rod G, 2300711, page 6
- c. ANL Destructive Chemical Assay of 33-Rod LWBR EOL Sample - Rod G, 2300711, page 7
- d. ANL Destructive Chemical Assay of 33-Rod LWBR EOL Sample - Rod G, 2300711, page 10
- e. ANL Destructive Chemical Assay of 33-Rod LWBR EOL Sample - Rod G, 2300711, page 11
- f. ANL Destructive Chemical Assay of 33-Rod LWBR EOL Sample - Rod G, 2300711, page 12
- g. ANL Destructive Chemical Assay of 33-Rod LWBR EOL Sample - Rod G, 2300711, page 13
- h. ANL Destructive Chemical Assay of 33-Rod LWBR EOL Sample - Rod G, 2300711, page 14
- i. (abundance of the specified isotope)(total weight of uranium) / 100
- j. Error Propagation = $((sd_x/x)^2 + (sd_y/y)^2)^{1/2}(xy)$, where sd is the +/- in the table
- k. (mole%)(number moles gas recovered)(molec wt) / 100
- m. (number of atoms per segment)(atomic weight) / 6.0228E+23
- n. Error Propagation = $(\text{SUM}(sd_i^2))^{1/2}$, where sd is the +/- in the table
- o. ((shear gas / Xe + Kr (diss&pl)))(moles Xe or Kr (diss + pl)) + moles Xe or Kr (diss + pl)
- p. Error Propagation = $(((((sd_x/x)^2 + (sd_y/y)^2 + (sd_z/z)^2)^{1/2} (xy/z))^2 + (sd_y)^2)^{1/2}$, where sd is the +/- in the table

Rod "H" 3211456 (R/V-3 B1)														
	H-00	H-01	H-02	H-03	H-04	H-05	H-06	H-07	H-08	H-09	H-10	H-11	H-12	H-13
seg length (in) ^a	6.262	6.434	6.99	6.954	6.99	6.989	6.962	6.982	6.97	6.982	6.949	7.011	6.963	
total length (in)														
U-232 wt% ^b	0	0.0031	0.0184	0.0432	0.0691	0.0958	0.1125	0.1259	0.129	0.1266	0.1197	0.101	0.0794	0
+ μ^b	0	0.0001	0.0006	0.0013	0.0021	0.003	0.0035	0.0039	0.004	0.0039	0.0037	0.0031	0.0025	0
U-232 g ^l	0.0000E+00	5.2142E-06	1.3360E-04	6.7697E-04	1.6291E-03	3.0159E-03	4.0274E-03	4.8931E-03	5.0960E-03	4.9242E-03	4.5181E-03	3.4419E-03	2.1571E-03	9.3699E-04
+ μ^l	NA	1.6822E-07	4.3565E-06	2.0372E-05	4.9510E-05	9.4446E-05	1.2530E-04	1.5158E-04	1.5806E-04	1.5170E-04	1.3966E-04	1.0565E-04	6.7919E-05	2.8457E-05
Segment Total														
+ μ^s														
U-233 wt% ^b	100	99.6564	99.0447	97.9966	96.8945	95.5857	94.7745	94.2144	94.0069	94.1914	94.3476	95.0824	96.2119	97.0000
+ μ^b	0	0.0412	0.0122	0.0083	0.007	0.0072	0.0078	0.0081	0.0079	0.0081	0.0077	0.0084	0.0089	0
U-233 g ^l	4.0000E-05	1.6762E-01	7.1912E-01	1.5357E+00	2.2844E+00	3.0092E+00	3.3929E+00	3.6616E+00	3.7136E+00	3.6636E+00	3.5611E+00	3.2403E+00	2.6138E+00	1.8493E+00
+ μ^l	1.0000E-05	1.1334E-04	1.9025E-04	3.4856E-04	5.3941E-04	5.9894E-04	7.1107E-04	7.9081E-04	2.8468E-03	7.8212E-04	7.4755E-04	7.0710E-04	5.8179E-04	4.7011E-04
Segment Total														
+ μ^s														
U-234 wt% ^b	0	0.2609	0.8942	1.8737	2.8474	3.9693	4.6345	5.0898	5.2635	5.1124	4.9977	4.4001	3.4468	2.0000
+ μ^b	0	0.0006	0.0006	0.0006	0.0006	0.0007	0.0007	0.0008	0.0008	0.0008	0.0007	0.0007	0.0007	0
U-234 g ^l	0.0000E+00	4.3883E-04	6.4924E-03	2.9362E-02	6.7129E-02	1.2496E-01	1.6591E-01	1.9781E-01	2.0793E-01	1.9885E-01	1.8864E-01	1.4995E-01	9.3640E-02	4.4000E-02
+ μ^l	NA	1.0362E-06	4.6140E-06	1.1253E-05	2.0684E-05	3.1869E-05	4.0627E-05	5.0027E-05	1.6155E-04	4.9778E-05	4.5046E-05	3.8266E-05	2.6852E-05	1.5444E-05
Segment Total														
+ μ^s														
U-235 wt% ^b	0	0.0039	0.0185	0.0766	0.1783	0.334	0.458	0.5438	0.5738	0.5438	0.511	0.3987	0.2493	0
+ μ^b	0	0.0305	0.0092	0.0063	0.0052	0.0052	0.0056	0.0057	0.0055	0.0057	0.0054	0.0062	0.0066	0
U-235 g ^l	0.0000E+00	6.5598E-06	1.3432E-04	1.2004E-03	4.2035E-03	1.0515E-02	1.6396E-02	2.1135E-02	2.2667E-02	2.1151E-02	1.9288E-02	1.3587E-02	6.7728E-03	2.1793E-03
+ μ^l	NA	5.1301E-05	6.6798E-05	9.8725E-05	1.2260E-04	1.6371E-04	2.0050E-04	2.2157E-04	2.1796E-04	2.2174E-04	2.0386E-04	2.1130E-04	1.7931E-04	1.2700E-04
Segment Total														
+ μ^s														
U-236 wt% ^b	0	0.0014	0.0003	0.0012	0.0042	0.01	0.0159	0.0214	0.0229	0.0212	0.0193	0.013	0.0065	0
+ μ^b	0	0.0002	0.0002	0.0002	0.0001	0.0001	0.0001	0.0001	0.0001	0.0001	0.0001	0.0001	0.0001	0
U-236 g ^l	0.0000E+00	2.3548E-06	2.1782E-06	1.8805E-05	9.9018E-05	3.1481E-04	5.6921E-04	8.3170E-04	9.0463E-04	8.2458E-04	7.2847E-04	4.4302E-04	1.7659E-04	4.7411E-05
+ μ^l	NA	3.3640E-07	1.4521E-06	3.1341E-06	2.3577E-06	3.1487E-06	3.5816E-06	3.8900E-06	4.0101E-06	3.8929E-06	3.7771E-06	3.4090E-06	2.7169E-06	1.8961E-06
Segment Total														
+ μ^s														
U-238 wt% ^b	0	0.0744	0.024	0.0086	0.0065	0.0053	0.0045	0.0048	0.0039	0.0047	0.0048	0.0048	0.0061	0
+ μ^b	0	0.0278	0.0082	0.0055	0.0045	0.0045	0.0049	0.005	0.0048	0.005	0.0048	0.0054	0.0059	0
U-238 g ^l	0.0000E+00	1.2514E-04	1.7425E-04	1.3477E-04	1.5324E-04	1.6685E-04	1.6110E-04	1.8655E-04	1.5406E-04	1.8281E-04	1.8118E-04	1.6358E-04	1.6572E-04	1.6693E-04
+ μ^l	NA	4.6760E-05	5.9537E-05	8.6188E-05	1.0609E-04	1.4167E-04	1.7542E-04	1.9432E-04	1.8962E-04	1.9448E-04	1.8118E-04	1.8402E-04	1.6029E-04	1.1380E-04
Segment Total														
+ μ^s														
tot U ^c	0.00005	0.1682	0.72606	1.56706	2.35757	3.14813	3.57994	3.88647	3.95037	3.88954	3.77448	3.40785	2.71671	1.84000
+ μ^c	0.00001	0.00009	0.00017	0.00033	0.00053	0.00058	0.00069	0.00077	0.00301	0.00076	0.00073	0.00068	0.00055	0.00000
Kr-82 (mol%) ^d	0	0	0	0	0	0	0	0	0	0	0	0	0	0
+ μ^d	0	0	0	0	0	0	0	0	0	0	0	0	0	0
Kr-82 (g) ^e	0.0000E+00	0.0000E+00	0.0000E+00	0.0000E+00	0.0000E+00	0.0000E+00	0.0000E+00	0.0000E+00	0.0000E+00	0.0000E+00	0.0000E+00	0.0000E+00	0.0000E+00	0.0000E+00
+ μ^e	NA	NA	NA	NA	NA	NA	NA	NA	NA	NA	NA	NA	NA	NA
Segment Total														
+ μ^s														

B-41

Rod "H" 3211456 (RIV-3 B1)														
	H-00	H-01	H-02	H-03	H-04	H-05	H-06	H-07	H-08	H-09	H-10	H-11	H-12	H-13
seg length (in) ^a	6.262	6.434	6.99	6.954	6.99	6.989	6.962	6.982	6.97	6.982	6.949	7.011	6.963	
total length (in)														
Kr-83 (mol%) ^d	15.6	15.6	15.6	15.6	15.6	15.6	15.6	15.6	15.6	15.6	15.6	15.6	15.6	15.6
+/- ^d	0.2	0.2	0.2	0.2	0.2	0.2	0.2	0.2	0.2	0.2	0.2	0.2	0.2	0.2
Kr-83 (g) ^k	0.0000E+00	0.0000E+00	0.0000E+00	1.0994E-03	1.8108E-03	3.2382E-03	3.7187E-03	5.8217E-03	6.4289E-03	6.3507E-03	5.0662E-03	5.1437E-03	3.6375E-03	1.30
+/- ^l	NA	NA	NA	3.6244E-04	4.6622E-04	6.4806E-04	5.3246E-04	8.0542E-04	1.4769E-03	7.0320E-04	7.4013E-04	7.4022E-04	1.2167E-03	2.4
Segment Total														
+/- ^h														
Kr-84 (mol%) ^d	29.3	29.3	29.3	29.3	29.3	29.3	29.3	29.3	29.3	29.3	29.3	29.3	29.3	29.3
+/- ^d	0.3	0.3	0.3	0.3	0.3	0.3	0.3	0.3	0.3	0.3	0.3	0.3	0.3	0.3
Kr-84 (g) ^k	0.0000E+00	0.0000E+00	0.0000E+00	2.0898E-03	3.4421E-03	6.1552E-03	7.0684E-03	1.1066E-02	1.2220E-02	1.2071E-02	9.6297E-03	9.7771E-03	6.9142E-03	2.5
+/- ^l	NA	NA	NA	6.8874E-04	8.8580E-04	1.2309E-03	1.0106E-03	1.5286E-03	2.8056E-03	1.3334E-03	1.4049E-03	1.4050E-03	2.3122E-03	4.6
Segment Total														
+/- ^h														
Kr-85 (mol%) ^d	6.1	6.1	6.1	6.1	6.1	6.1	6.1	6.1	6.1	6.1	6.1	6.1	6.1	6.1
+/- ^d	0.2	0.2	0.2	0.2	0.2	0.2	0.2	0.2	0.2	0.2	0.2	0.2	0.2	0.2
Kr-85 (g) ^k	0.0000E+00	0.0000E+00	0.0000E+00	4.4027E-04	7.2515E-04	1.2967E-03	1.4891E-03	2.3313E-03	2.5745E-03	2.5432E-03	2.0287E-03	2.0598E-03	1.4567E-03	5.4
+/- ^l	NA	NA	NA	1.4575E-04	1.8798E-04	2.6245E-04	2.1791E-04	3.3011E-04	5.9649E-04	2.9187E-04	3.0264E-04	3.0287E-04	4.8922E-04	1.0
Segment Total														
+/- ^h														
Kr-86 (mol%) ^d	49.2	49.2	49.2	49.2	49.2	49.2	49.2	49.2	49.2	49.2	49.2	49.2	49.2	49.2
+/- ^d	0.3	0.3	0.3	0.3	0.3	0.3	0.3	0.3	0.3	0.3	0.3	0.3	0.3	0.3
Kr-86 (g) ^k	0.0000E+00	0.0000E+00	0.0000E+00	3.5928E-03	5.9175E-03	1.0582E-02	1.2152E-02	1.9024E-02	2.1009E-02	2.0753E-02	1.6555E-02	1.6809E-02	1.1887E-02	4.4
+/- ^l	NA	NA	NA	1.1837E-03	1.5221E-03	2.1144E-03	1.7346E-03	2.6232E-03	4.8203E-03	2.2860E-03	2.4114E-03	2.4115E-03	3.9739E-03	8.0
Segment Total														
+/- ^h														
Rod Total														
+/- ^h														
shear gas (g) ^e	0	0	0	0	0	0.0002	0.0003	0.0006	0.0006	0.0006	0.0004	0.0003	0.0001	
+/- ^e	0	0	0	0	0	0	0.0001	0.0001	0.0001	0.0001	0.0001	0.0001	0	
moles Kr (diss+pl) ^d	0	0	0	0.000085	0.00014	0.00025	0.000287	0.000449	0.000496	0.00049	0.000391	0.000397	0.000281	0
+/- ^d	0	0	0	0.000028	0.000036	0.00005	0.000041	0.000062	0.000114	0.000054	0.000057	0.000057	0.000094	0
Kr+Xe diss&pl (g) ^d	0.0001	0	0	0.0476	0.073	0.1419	0.1729	0.2471	0.288	0.2973	0.232	0.1782	0.1244	
+/- ^d	0	0	0	0.0068	0.007	0.0141	0.0169	0.0342	0.0372	0.0296	0.0137	0.016	0.0149	
moles kr (tot) ^o	0	0	0	8.5000E-05	1.4000E-04	2.5035E-04	2.8750E-04	4.5009E-04	4.9703E-04	4.9099E-04	3.9167E-04	3.9767E-04	2.8123E-04	1.0
+/- ^p	0	0	0	2.8000E-05	3.6000E-05	5.0000E-05	4.1000E-05	6.2001E-05	1.1400E-04	5.4000E-05	5.7000E-05	5.7001E-05	9.4000E-05	1.9
Xe-128 (mol%) ^d	0	0	0	0	0	0	0	0	0	0	0	0	0	0
+/- ^d	0	0	0	0	0	0	0	0	0	0	0	0	0	0
Xe-128 (g) ^k	0.0000E+00	0.0000E+00	0.0000E+00	0.0000E+00	0.0000E+00	0.0000E+00	0.0000E+00	0.0000E+00	0.0000E+00	0.0000E+00	0.0000E+00	0.0000E+00	0.0000E+00	0.00
+/- ^l	NA	NA	NA	NA	NA	NA	NA	NA	NA	NA	NA	NA	NA	NA
SegmentTotal														
+/- ^h														

Rod "H" 3211456 (R-V-3 B1)														
	H-00	H-01	H-02	H-03	H-04	H-05	H-06	H-07	H-08	H-09	H-10	H-11	H-12	H-13
seg length (in) ^a	6.262	6.434	6.99	6.954	6.99	6.989	6.962	6.982	6.97	6.982	6.949	7.011	6.963	6.982
total length (in)														
Xe-130 (mol%) ^d	0	0	0	0	0	0	0	0	0	0	0	0	0	0
+/- ^d	0	0	0	0	0	0	0	0	0	0	0	0	0	0
Xe-130 (g) ^b	0.0000E+00	0.0000E+00	0.0000E+00	0.0000E+00	0.0000E+00	0.0000E+00	0.0000E+00	0.0000E+00	0.0000E+00	0.0000E+00	0.0000E+00	0.0000E+00	0.0000E+00	0.0000E+00
+/- ^l	NA	NA	NA	NA	NA	NA	NA	NA	NA	NA	NA	NA	NA	NA
SegmentTotal														
+/- ^l														
Xe-131 (mol%) ^d	12.7	12.7	12.7	12.7	12.7	12.7	12.7	12.7	12.7	12.7	12.7	12.7	12.7	12.7
+/- ^d	0.1	0.1	0.1	0.1	0.1	0.1	0.1	0.1	0.1	0.1	0.1	0.1	0.1	0.1
Xe-131 (g) ^b	1.6625E-05	0.0000E+00	0.0000E+00	5.0041E-03	7.5644E-03	1.4967E-02	1.8419E-02	2.5965E-02	3.0504E-02	3.1734E-02	2.4664E-02	1.7919E-02	1.2462E-02	5.0000E-03
+/- ^l	1.3091E-07	NA	NA	7.8237E-04	7.8364E-04	1.6667E-03	2.0500E-03	3.5968E-03	4.4454E-03	3.6329E-03	1.5913E-03	1.8839E-03	1.5658E-03	7.0000E-04
SegmentTotal														
+/- ^l														
Xe-132 (mol%) ^d	21.2	21.2	21.2	21.2	21.2	21.2	21.2	21.2	21.2	21.2	21.2	21.2	21.2	21.2
+/- ^d	0.2	0.2	0.2	0.2	0.2	0.2	0.2	0.2	0.2	0.2	0.2	0.2	0.2	0.2
Xe-132 (g) ^b	2.7964E-05	0.0000E+00	0.0000E+00	8.4171E-03	1.2723E-02	2.5175E-02	3.0981E-02	4.3673E-02	5.1308E-02	5.3378E-02	4.1486E-02	3.0140E-02	2.0962E-02	8.0000E-03
+/- ^l	2.6381E-07	NA	NA	1.3167E-03	1.3198E-03	2.8064E-03	3.4520E-03	6.0543E-03	7.4820E-03	6.1169E-03	2.6853E-03	3.1727E-03	2.6360E-03	1.0000E-03
SegmentTotal														
+/- ^l														
Xe-134 (mol%) ^d	26.1	26.1	26.1	26.1	26.1	26.1	26.1	26.1	26.1	26.1	26.1	26.1	26.1	26.1
+/- ^d	0.2	0.2	0.2	0.2	0.2	0.2	0.2	0.2	0.2	0.2	0.2	0.2	0.2	0.2
Xe-134 (g) ^b	3.4949E-05	0.0000E+00	0.0000E+00	1.0520E-02	1.5902E-02	3.1464E-02	3.8721E-02	5.4583E-02	6.4125E-02	6.6713E-02	5.1849E-02	3.7669E-02	2.6198E-02	1.0000E-02
+/- ^l	2.6781E-07	NA	NA	1.6446E-03	1.6471E-03	3.5032E-03	4.3091E-03	7.5607E-03	9.3445E-03	7.6361E-03	3.3440E-03	3.9599E-03	3.2914E-03	1.0000E-03
SegmentTotal														
+/- ^l														
Xe-136 (mol%) ^d	40.1	40.1	40.1	40.1	40.1	40.1	40.1	40.1	40.1	40.1	40.1	40.1	40.1	40.1
+/- ^d	0.3	0.3	0.3	0.3	0.3	0.3	0.3	0.3	0.3	0.3	0.3	0.3	0.3	0.3
Xe-136 (g) ^b	5.4499E-05	0.0000E+00	0.0000E+00	1.6404E-02	2.4797E-02	4.9063E-02	6.0380E-02	8.5115E-02	9.9995E-02	1.0403E-01	8.0852E-02	5.8739E-02	4.0852E-02	1.5000E-02
+/- ^l	4.0772E-07	NA	NA	2.5644E-03	2.5682E-03	5.4622E-03	6.7187E-03	1.1789E-02	1.4570E-02	1.1906E-02	5.2127E-03	6.1741E-03	5.1320E-03	2.0000E-03
SegmentTotal														
+/- ^l														
Rod total														
+/- ^l														
shear gas (g) ^e	0	0	0	0	0	0.0002	0.0003	0.0006	0.0006	0.0006	0.0004	0.0003	0.0001	0.0001
+/- ^e	0	0	0	0	0	0	0.0001	0.0001	0.0001	0.0001	0.0001	0.0001	0.0001	0
moles Xe (diss+pl) ^d	0.000001	0	0	0.000301	0.000455	0.000899	0.001106	0.001558	0.001831	0.001905	0.001481	0.001076	0.000749	0.000294
+/- ^d	0	0	0	0.000047	0.000047	0.0001	0.000123	0.000216	0.000267	0.000218	0.000095	0.000113	0.000094	0.000047
Kr+Xe diss&pl (g) ^d	0.0001	0	0	0.0476	0.073	0.1419	0.1729	0.2471	0.288	0.2973	0.232	0.1782	0.1244	0.0476
+/- ^d	0	0	0	0.0068	0.007	0.0141	0.0169	0.0342	0.0372	0.0296	0.0137	0.016	0.0149	0.0074
moles Xe (tot) ^o	1.0000E-06	0	0	3.0100E-04	4.5500E-04	9.0027E-04	1.1079E-03	1.5618E-03	1.8348E-03	1.9088E-03	1.4836E-03	1.0778E-03	7.4960E-04	2.7000E-04
+/- ^p	0.0000E+00	0	0	4.7000E-05	4.7000E-05	1.0000E-04	1.2300E-04	2.1600E-04	2.6700E-04	2.1800E-04	9.5002E-05	1.1300E-04	9.4000E-05	4.0000E-05

B-43

Rod "H" 3211456 (R-V-3 B1)													
	H-00	H-01	H-02	H-03	H-04	H-05	H-06	H-07	H-08	H-09	H-10	H-11	H-12
seg length (in) ^a	6.262	6.434	6.99	6.954	6.99	6.989	6.962	6.982	6.97	6.982	6.949	7.011	6.963
total length (in)													
Values corrected to 1/1/84 (page 181, Final Report for the LWBR Proof of Breeding Analytical Support Project)													
Cs-137 (atoms) ^f	NA	6.7540E+17	8.6150E+18	3.5870E+19	7.9950E+19	1.4820E+20	1.9610E+20	2.3470E+20	2.4780E+20	2.3600E+20	2.2720E+20	1.7930E+20	1.1100E+20
+/- ^f	NA	2.3150E+15	2.9540E+16	1.2290E+17	2.7400E+17	4.1590E+17	6.7210E+17	8.0460E+17	7.3060E+17	8.0830E+17	7.7860E+17	5.9440E+17	3.5590E+17
Cs-137 (g) ^m	NA	1.5353E-04	1.9583E-03	8.1538E-03	1.8174E-02	3.3688E-02	4.4576E-02	5.3351E-02	5.6328E-02	5.3846E-02	5.1646E-02	4.0757E-02	2.5232E-02
+/- ^m	NA	5.2623E-07	6.7149E-06	2.7937E-05	6.2284E-05	9.4540E-05	1.5278E-04	1.8290E-04	1.6608E-04	1.8374E-04	1.7699E-04	1.3512E-04	8.0901E-05
Total													
+/- ¹													
Ce-144 (atoms) ^g	NA	8.9130E+16	9.9130E+17	3.6450E+18	7.1910E+18	1.2160E+19	1.5010E+19	1.7580E+19	1.8560E+19	1.7640E+19	1.6420E+19	1.2070E+19	7.0640E+18
+/- ^g	NA	5.1610E+14	5.7400E+15	2.1100E+16	4.1630E+16	6.4310E+16	8.6900E+16	1.0180E+17	9.1400E+16	1.0210E+17	9.5060E+16	6.9850E+16	4.0920E+16
Ce-144 (g) ^m	NA	2.1297E-05	2.3687E-04	8.7096E-04	1.7183E-03	2.9056E-03	3.5866E-03	4.2007E-03	4.4349E-03	4.2150E-03	3.9235E-03	2.8841E-03	1.6879E-03
+/- ^m	NA	1.2332E-07	1.3716E-06	5.0418E-06	9.9474E-06	1.5367E-05	2.0765E-05	2.4325E-05	2.1840E-05	2.4397E-05	2.2714E-05	1.6690E-05	9.7777E-06
Total													
+/- ¹													
Zr-95 (atoms) ¹	NA	1.0200E+15	9.4890E+15	3.4230E+16	6.7640E+16	1.0940E+17	1.3220E+17	1.4820E+17	1.5450E+17	1.4190E+17	1.2090E+17	6.9950E+16	3.0060E+16
+/- ¹	NA	4.8030E+13	1.3610E+14	6.6370E+14	1.4040E+15	1.7110E+15	1.8940E+15	2.7710E+15	2.7120E+15	2.9470E+15	2.5930E+15	1.7180E+15	8.2260E+14
Zr-95 (g) ^m	NA	1.6073E-07	1.4953E-06	5.3940E-06	1.0659E-05	1.7239E-05	2.0832E-05	2.3354E-05	2.4346E-05	2.2361E-05	1.9052E-05	1.1023E-05	4.7369E-06
+/- ^m	NA	7.5686E-09	2.1447E-08	1.0459E-07	2.2124E-07	2.6962E-07	2.9846E-07	4.3666E-07	4.2736E-07	4.6439E-07	4.0861E-07	2.7072E-07	1.2963E-07
Total													
+/- ¹													
Footnotes													
a. ANL Destructive Chemical Assay of 33-Rod LWBR EOL Sample - Rod H, 3211456, page 4													
b. ANL Destructive Chemical Assay of 33-Rod LWBR EOL Sample - Rod H, 3211456, page 7													
c. ANL Destructive Chemical Assay of 33-Rod LWBR EOL Sample - Rod H, 3211456, page 8													
d. ANL Destructive Chemical Assay of 33-Rod LWBR EOL Sample - Rod H, 3211456, page 11													
e. ANL Destructive Chemical Assay of 33-Rod LWBR EOL Sample - Rod H, 3211456, page 12													
f. ANL Destructive Chemical Assay of 33-Rod LWBR EOL Sample - Rod H, 3211456, page 13													
g. ANL Destructive Chemical Assay of 33-Rod LWBR EOL Sample - Rod H, 3211456, page 14													
h. ANL Destructive Chemical Assay of 33-Rod LWBR EOL Sample - Rod H, 3211456, page 15													
i. (abundance of the specified isotope)(total weight of uranium) / 100													
j. Error Propagation = $((sd_x/x)^2 + (sd_y/y)^2)^{1/2} (xy)$, where sd is the +/- in the table													
k. (mole%)(number moles gas recovered)(molec wt) / 100													
m. (number of atoms per segment)(atomic weight) / 6.0228E+23													
n. Error Propagation = $(\text{SUM}(sd_i^2))^{1/2}$, where sd is the +/- in the table													
o. $((\text{shear gas} / \text{Xe} + \text{Kr} (\text{diss} + \text{pl}))) (\text{moles Xe or Kr} (\text{diss} + \text{pl})) + \text{moles Xe or Kr} (\text{diss} + \text{pl})$													
p. Error Propagation = $((((sd_x/x)^2 + (sd_y/y)^2 + (sd_z/z)^2)^{1/2} (xyz))^2 + (sd_p)^2)^{1/2}$, where sd is the +/- in the table													

Rod "I" 1605519 (SBI-3 E56)

	I-00	I-01	I-02	I-03	I-04	I-05	I-06	I-07
seg length (in) ^a	11.027	11.202	14.297	14.095	14.098	14.097	14.096	1
total length (in)								
U-232 wt% ^b	0	0.0158	0.0358	0.1227	0.1852	0.1947	0.1575	
+/- ^b	0	0.0005	0.0011	0.0038	0.0057	0.006	0.0049	0
U-232 g ⁱ	0.0000E+00	6.6753E-05	3.3265E-03	1.1649E-02	1.8055E-02	1.8929E-02	1.4799E-02	5.359
+/- ^j	NA	2.1125E-06	1.0221E-04	3.6078E-04	5.5569E-04	5.8334E-04	4.6044E-04	1.697
Segment Total								
+/- ⁿ								
U-233 wt% ^b	100	99.061	94.0117	88.9998	86.0057	85.4541	86.8993	91
+/- ^b	0	0.0146	0.0062	0.0063	0.0069	0.0068	0.0069	0
U-233 g ⁱ	4.0000E-05	4.1852E-01	8.7354E+00	8.4494E+00	8.3844E+00	8.3079E+00	8.1654E+00	8.1764
+/- ^j	1.0000E-05	1.3392E-04	2.3014E-03	2.2267E-03	2.1628E-03	2.2281E-03	2.1095E-03	1.915
Segment Total								
+/- ⁿ								
U-234 wt% ^b	0	0.8865	5.1233	9.0783	11.2823	11.6908	10.6757	7
+/- ^b	0	0.0021	0.0019	0.0019	0.0019	0.0019	0.0019	0
U-234 g ⁱ	0.0000E+00	3.7454E-03	4.7605E-01	8.6187E-01	1.0999E+00	1.1366E+00	1.0031E+00	6.390
+/- ^j	NA	8.9358E-06	2.1427E-04	2.8356E-04	3.2714E-04	3.4476E-04	3.0445E-04	2.233
Segment Total								
+/- ⁿ								
U-235 wt% ^b	0	0.0187	0.5588	1.4793	2.1395	2.255	1.9008	0
+/- ^b	0	0.0103	0.0044	0.004	0.0037	0.0034	0.0041	0
U-235 g ⁱ	0.0000E+00	7.9006E-05	5.1923E-02	1.4044E-01	2.0857E-01	2.1923E-01	1.7861E-01	8.473
+/- ^j	NA	4.3516E-05	4.0905E-04	3.8142E-04	3.6431E-04	3.3528E-04	3.8774E-04	3.132
Segment Total								
+/- ⁿ								
U-236 wt% ^b	0	0	0.037	0.1122	0.1964	0.2143	0.1631	0
+/- ^b	0	0.0002	0.0002	0.0002	0.0002	0.0002	0.0002	0
U-236 g ⁱ	0.0000E+00	0.0000E+00	3.4380E-03	1.0652E-02	1.9146E-02	2.0834E-02	1.5325E-02	5.797
+/- ^j	NA	NA	1.8604E-05	1.9179E-05	2.0054E-05	2.0163E-05	1.9167E-05	1.791
Segment Total								
+/- ⁿ								

B-45

Rod "I" 1605519 (SBI-3 E56)

	I-00	I-01	I-02	I-03	I-04	I-05	I-06	I-07
seg length (in) ^a	11.027	11.202	14.297	14.095	14.098	14.097	14.096	1
total length (in)								
U-238 wt% ^b	0	0.018	0.2334	0.2076	0.191	0.1912	0.2037	0
+/- ^b	0	0.0103	0.0043	0.004	0.0037	0.0034	0.0042	0
U-238 g ^l	0.0000E+00	7.6048E-05	2.1687E-02	1.9709E-02	1.8620E-02	1.8589E-02	1.9140E-02	2.093
+/- ^l	NA	4.3516E-05	3.9959E-04	3.7978E-04	3.6073E-04	3.3058E-04	3.9468E-04	3.126
Segment Total								
+/- ⁿ								
tot U ^c	0.00011	0.42249	9.29183	9.49378	9.74871	9.72203	9.39636	8.9
+/- ^c	0.00001	0.00012	0.00237	0.00241	0.00239	0.00249	0.00231	0.0
Kr-82 (mol%) ^d	0.2	0.2	0.2	0.2	0.2	0.2	0.2	
+/- ^d	0.1	0.1	0.1	0.1	0.1	0.1	0.1	
Kr-82 (g) ^k	9.8296E-07	0.0000E+00	1.3670E-04	2.6405E-04	4.5848E-04	3.5089E-04	3.7442E-04	1.920
+/- ^j	4.9148E-07	NA	7.0440E-05	1.3417E-04	2.3408E-04	1.7973E-04	1.9106E-04	1.027
Segment Total								
+/- ⁿ								
Kr-83 (mol%) ^d	15.4	15.4	15.4	15.4	15.4	15.4	15.4	
+/- ^d	0.1	0.1	0.1	0.1	0.1	0.1	0.1	
Kr-83 (g) ^k	7.6613E-05	0.0000E+00	1.0654E-02	2.0580E-02	3.5734E-02	2.7349E-02	2.9182E-02	1.497
+/- ^j	4.9748E-07	NA	1.3298E-03	1.8691E-03	3.6975E-03	3.0442E-03	2.9812E-03	2.849
Segment Total								
+/- ⁿ								
Kr-84 (mol%) ^d	30.2	30.2	30.2	30.2	30.2	30.2	30.2	
+/- ^d	0.2	0.2	0.2	0.2	0.2	0.2	0.2	
Kr-84 (g) ^k	1.5205E-04	0.0000E+00	2.1145E-02	4.0844E-02	7.0919E-02	5.4277E-02	5.7916E-02	2.971
+/- ^j	1.0069E-06	NA	2.6392E-03	3.7098E-03	7.3388E-03	6.0420E-03	5.9171E-03	5.654
Segment Total								
+/- ⁿ								

B-46

Rod "I" 1605519 (SBI-3 E56)

	I-00	I-01	I-02	I-03	I-04	I-05	I-06	I-07
seg length (in) ^a	11.027	11.202	14.297	14.095	14.098	14.097	14.096	14.096
total length (in)								
Kr-85 (mol%) ^d	5.8	5.8	5.8	5.8	5.8	5.8	5.8	5.8
+/- ^d	0.1	0.1	0.1	0.1	0.1	0.1	0.1	0.1
Kr-85 (g) ^k	2.9550E-05	0.0000E+00	4.1093E-03	7.9377E-03	1.3783E-02	1.0548E-02	1.1256E-02	5.7744E-02
+/- ^j	5.0947E-07	NA	5.1707E-04	7.3196E-04	1.4430E-03	1.1862E-03	1.1638E-03	1.1020E-03
Segment Total								
+/- ⁿ								
Kr-86 (mol%) ^d	48.6	48.6	48.6	48.6	48.6	48.6	48.6	48.6
+/- ^d	0.2	0.2	0.2	0.2	0.2	0.2	0.2	0.2
Kr-86 (g) ^k	2.5052E-04	0.0000E+00	3.4838E-02	6.7295E-02	1.1685E-01	8.9427E-02	9.5423E-02	4.8953E-01
+/- ^j	1.0309E-06	NA	4.3447E-03	6.1023E-03	1.2076E-02	9.9441E-03	9.7364E-03	9.3130E-03
Segment Total								
+/- ⁿ								
Rod Total								
+/- ⁿ								
shear gas (g) ^e	0	0	0.0009	0.0023	0.0033	0.0033	0.003	0
+/- ^e	0	0.0003	0.0003	0.0005	0.0007	0.0007	0.0006	0
moles Kr (diss+pl) ^d	0.000006	0	0.000833	0.001608	0.002793	0.002137	0.00228	0.00228
+/- ^d	0	0	0.000104	0.000146	0.000289	0.000238	0.000233	0.000233
Kr+Xe diss&pl (g) ^d	0.0033	0	0.5392	0.9869	1.6595	1.4567	1.2554	0
+/- ^d	0.0002	0	0.0228	0.0666	0.1317	0.1291	0.1265	0
moles kr (tot) ^o	6.0000E-06	0	8.3439E-04	1.6117E-03	2.7986E-03	2.1418E-03	2.2854E-03	1.1724E-02
+/- ^p	0.0000E+00	0.0000E+00	1.0400E-04	1.4600E-04	2.8900E-04	2.3800E-04	2.3300E-04	2.2300E-04
Xe-128 (mol%) ^d	0.1	0.1	0.1	0.1	0.1	0.1	0.1	0.1
+/- ^d	0	0	0	0	0	0	0	0
Xe-128 (g) ^k	2.6860E-06	0.0000E+00	4.4713E-04	8.1216E-04	1.3578E-03	1.2177E-03	1.0141E-03	5.8560E-03
+/- ^j	1.2790E-13	NA	1.9955E-05	6.2291E-05	1.2317E-04	1.2151E-04	1.1908E-04	5.6918E-04
SegmentTotal								
+/- ⁿ								

B-47

Rod "I" 1605519 (SBI-3 E56)

	I-00	I-01	I-02	I-03	I-04	I-05	I-06	I-07
seg length (in) ^a	11.027	11.202	14.297	14.095	14.098	14.097	14.096	1
total length (in)								
Xe-130 (mol%) ^d	0.1	0.1	0.1	0.1	0.1	0.1	0.1	0.1
+/- ^d	0	0	0	0	0	0	0	0
Xe-130 (g) ^k	2.7280E-06	0.0000E+00	4.5412E-04	8.2486E-04	1.3791E-03	1.2367E-03	1.0300E-03	5.9470E-03
+/- ^j	1.2990E-13	NA	2.0267E-05	6.3265E-05	1.2510E-04	1.2341E-04	1.2094E-04	5.7800E-04
SegmentTotal								
+/- ⁿ								
Xe-131 (mol%) ^d	11.4	11.4	11.4	11.4	11.4	11.4	11.4	11.4
+/- ^d	0.1	0.1	0.1	0.1	0.1	0.1	0.1	0.1
Xe-131 (g) ^k	3.1339E-04	0.0000E+00	5.2169E-02	9.4759E-02	1.5843E-01	1.4208E-01	1.1832E-01	6.8320E-01
+/- ^j	2.7490E-06	NA	2.3728E-03	7.3152E-03	1.4438E-02	1.4232E-02	1.3932E-02	6.6680E-02
SegmentTotal								
+/- ⁿ								
Xe-132 (mol%) ^d	22.7	22.7	22.7	22.7	22.7	22.7	22.7	22.7
+/- ^d	0.1	0.1	0.1	0.1	0.1	0.1	0.1	0.1
Xe-132 (g) ^k	6.2879E-04	0.0000E+00	1.0467E-01	1.9013E-01	3.1787E-01	2.8507E-01	2.3741E-01	1.3700E-01
+/- ^j	2.7700E-06	NA	4.6941E-03	1.4606E-02	2.8869E-02	2.8473E-02	2.7896E-02	1.3330E-02
SegmentTotal								
+/- ⁿ								
Xe-134 (mol%) ^d	25.8	25.8	25.8	25.8	25.8	25.8	25.8	25.8
+/- ^d	0.1	0.1	0.1	0.1	0.1	0.1	0.1	0.1
Xe-134 (g) ^k	7.2550E-04	0.0000E+00	1.2077E-01	2.1937E-01	3.6676E-01	3.2891E-01	2.7392E-01	1.5810E-01
+/- ^j	2.8120E-06	NA	5.4101E-03	1.6847E-02	3.3300E-02	3.2845E-02	3.2182E-02	1.5380E-02
SegmentTotal								
+/- ⁿ								

B-48

Rod "I" 1605519 (SBI-3 E56)

	I-00	I-01	I-02	I-03	I-04	I-05	I-06	I-07
seg length (in) ^a	11.027	11.202	14.297	14.095	14.098	14.097	14.096	
total length (in)								
Xe-136 (mol%) ^d	40	40	40	40	40	40	40	
+/- ^d	0.1	0.1	0.1	0.1	0.1	0.1	0.1	
Xe-136 (g) ^k	1.1416E-03	0.0000E+00	1.9004E-01	3.4519E-01	5.7712E-01	5.1756E-01	4.3104E-01	2.48
+/- ^j	2.8541E-06	NA	8.4946E-03	2.6489E-02	5.2372E-02	5.1662E-02	5.0624E-02	2.42
SegmentTotal								
+/- ⁿ								
Rod total								
+/- ⁿ								
shear gas (g) ^e	0	0	0.0009	0.0023	0.0033	0.0033	0.003	
+/- ^e	0	0.0003	0.0003	0.0005	0.0007	0.0007	0.0006	
moles Xe (diss+pl) ^d	0.000021	0	0.00349	0.006335	0.010595	0.009499	0.00791	0.
+/- ^d	0.000001	0	0.000156	0.000487	0.000963	0.00095	0.000931	0.
Kr+Xe diss&pl (g) ^d	0.0033	0	0.5392	0.9869	1.6595	1.4567	1.2554	
+/- ^d	0.0002	0	0.0228	0.0666	0.1317	0.1291	0.1265	
moles Xe (tot) ^o	2.1000E-05	0	3.4958E-03	6.3498E-03	1.0616E-02	9.5205E-03	7.9289E-03	4.57
+/- ^p	1.0000E-12	0.0000E+00	1.5601E-04	4.8701E-04	9.6301E-04	9.5002E-04	9.3101E-04	4.45
Values corrected to 1/1/84 (page 181, Final Report for the LWBR Proof of Breeding Analytical Support Project)								
Cs-137 (atoms) ^f	ND	4.7130E+18	4.8210E+20	1.0350E+21	1.3880E+21	1.4450E+21	1.2550E+21	7.26
+/- ^f	NA	2.0920E+16	2.1300E+18	4.5800E+18	6.1340E+18	6.1360E+18	5.3250E+18	3.21
Cs-137 (g) ^m	NA	1.0713E-03	1.0959E-01	2.3527E-01	3.1551E-01	3.2847E-01	2.8528E-01	1.65
+/- ^m	NA	4.7554E-06	4.8418E-04	1.0411E-03	1.3943E-03	1.3948E-03	1.2104E-03	7.29
Total								
+/- ⁿ								
Ce-144 (atoms) ^g	ND	5.9550E+17	3.2600E+19	5.5100E+19	6.8020E+19	7.1360E+19	5.5720E+19	2.72
+/- ^g	NA	3.7660E+15	2.2010E+17	3.8120E+17	4.5920E+17	4.6020E+17	3.6670E+17	1.88
Ce-144 (g) ^m	NA	1.4229E-04	7.7897E-03	1.3166E-02	1.6253E-02	1.7051E-02	1.3314E-02	6.49
+/- ^m	NA	8.9988E-07	5.2592E-05	9.1087E-05	1.0972E-04	1.0996E-04	8.7622E-05	4.49
Total								
+/- ⁿ								

B-49

Rod "I" 1605519 (SBI-3 E56)

	I-00	I-01	I-02	I-03	I-04	I-05	I-06	I-07
seg length (in) ^a	11.027	11.202	14.297	14.095	14.098	14.097	14.096	
total length (in)								
Zr-95 (atoms) ^h	ND	6.5160E+15	2.6370E+17	4.4440E+17	5.2800E+17	5.3660E+17	2.6590E+17	7.15
+/- ⁿ	NA	1.3700E+14	1.0230E+16	1.9070E+16	1.9940E+16	2.6800E+16	1.6250E+16	8.72
Zr-95 (g) ^m	NA	1.0268E-06	4.1554E-05	7.0029E-05	8.3203E-05	8.4558E-05	4.1901E-05	1.12
+/- ^m	NA	2.1589E-08	1.6121E-06	3.0051E-06	3.1422E-06	4.2232E-06	2.5607E-06	1.37
Total								
+/- ⁿ								

Footnotes

- a. ANL Destructive Chemical Assay of 33-Rod LWBR EOL Sample - Rod I, 1605519, page 3
- b. ANL Destructive Chemical Assay of 33-Rod LWBR EOL Sample - Rod I, 1605519, page 6
- c. ANL Destructive Chemical Assay of 33-Rod LWBR EOL Sample - Rod I, 1605519, page 7
- d. ANL Destructive Chemical Assay of 33-Rod LWBR EOL Sample - Rod I, 1605519, page 10
- e. ANL Destructive Chemical Assay of 33-Rod LWBR EOL Sample - Rod I, 1605519, page 11
- f. ANL Destructive Chemical Assay of 33-Rod LWBR EOL Sample - Rod I, 1605519, page 12
- g. ANL Destructive Chemical Assay of 33-Rod LWBR EOL Sample - Rod I, 1605519, page 13
- h. ANL Destructive Chemical Assay of 33-Rod LWBR EOL Sample - Rod I, 1605519, page 14
- i. (abundance of the specified isotope)(total weight of uranium) / 100
- j. Error Propagation = $((sd_x/x)^2 + (sd_y/y)^2)^{1/2}(xy)$, where sd is the +/- in the table
- k. (mole%)(number moles gas recovered)(molec wt) / 100
- m. (number of atoms per segment)(atomic weight) / 6.0228E+23
- n. Error Propagation = $(SUM(sd_i^2))^{1/2}$, where sd is the +/- in the table
- o. $((shear\ gas / Xe + Kr\ (diss\ \&\ pl)))(moles\ Xe\ or\ Kr\ (diss\ +\ pl)) + moles\ Xe\ or\ Kr\ (diss\ +\ pl)$
- p. Error Propagation = $(((((sd_x/x)^2 + (sd_y/y)^2 + (sd_z/z)^2)^{1/2} (xy/z))^2 + (sd_y)^2)^{1/2}$, where sd is the +/- in the table

Rod "J" 1200830 (SBI-3 A49)

	J-00	J-01	J-02	J-03	J-04	J-05	J-06	J-07
seg length (in) ^a	11.319	11.439	14.242	14.043	14.133	13.913	10.498	1
total length (in)								
U-232 wt% ^b	0	0.0176	0.0564	0.1686	0.236	0.2702	0.2543	0
+/- ^b	0	0.0005	0.0017	0.0052	0.0073	0.0084	0.0079	0
U-232 g ^l	0.0000E+00	9.7451E-05	3.7210E-03	1.2703E-02	1.9381E-02	1.8384E-02	1.1966E-02	8.084
+/- ^l	NA	2.7686E-06	1.1216E-04	3.9190E-04	5.9953E-04	5.7154E-04	3.7173E-04	2.501
Segment Total								
+/- ⁿ								
U-233 wt% ^b	100	98.733	92.715	86.8737	83.8016	86.2766	87.817	91
+/- ^b	0	0.0119	0.0091	0.009	0.0093	0.0107	0.0094	0
U-233 g ^l	4.0000E-05	5.4668E-01	6.1169E+00	6.5455E+00	6.8822E+00	5.8700E+00	4.1321E+00	4.2491
+/- ^l	1.0000E-05	1.5313E-04	1.7998E-03	4.8173E-03	2.1044E-03	1.8173E-03	1.0945E-03	9.163
Segment Total								
+/- ⁿ								
U-234 wt% ^b	0	1.1844	6.2385	10.6871	12.8591	11.0657	9.9651	7
+/- ^b	0	0.0008	0.001	0.0015	0.0017	0.0017	0.0013	0
U-234 g ^l	0.0000E+00	6.5580E-03	4.1159E-01	8.0522E-01	1.0560E+00	7.5288E-01	4.6889E-01	3.272
+/- ^l	NA	4.7298E-06	1.3186E-04	5.9751E-04	3.3171E-04	2.4288E-04	1.2902E-04	7.603
Segment Total								
+/- ⁿ								
U-235 wt% ^b	0	0.0375	0.744	1.9413	2.6703	2.1709	1.8062	0
+/- ^b	0	0.0093	0.0075	0.0069	0.0063	0.0069	0.0057	0
U-235 g ^l	0.0000E+00	2.0764E-04	4.9086E-02	1.4627E-01	2.1930E-01	1.4770E-01	8.4988E-02	4.551
+/- ^l	NA	5.1494E-05	4.9501E-04	5.3069E-04	5.2114E-04	4.7132E-04	2.6899E-04	1.994
Segment Total								
+/- ⁿ								
U-236 wt% ^b	0	0.0012	0.0457	0.1746	0.3007	0.2136	0.1553	0
+/- ^b	0	0.0001	0.0001	0.0001	0.0001	0.0001	0.0001	0
U-236 g ^l	0.0000E+00	6.6444E-06	3.0151E-03	1.3155E-02	2.4695E-02	1.4533E-02	7.3074E-03	2.765
+/- ^l	NA	5.5370E-07	6.6504E-06	1.2192E-05	1.0815E-05	7.9552E-06	5.0274E-06	4.666
Segment Total								
+/- ⁿ								

B-51

Rod "J" 1200830 (SBI-3 A49)

	J-00	J-01	J-02	J-03	J-04	J-05	J-06	J-07
seg length (in) ^a	11.319	11.439	14.242	14.043	14.133	13.913	10.498	1
total length (in)								
U-238 wt% ^b	0	0.0263	0.2004	0.1548	0.1324	0.003	0.0021	0
+/- ^b	0	0.0076	0.006	0.0055	0.0051	0.0056	0.0043	0
U-238 g ^l	0.0000E+00	1.4562E-04	1.3222E-02	1.1663E-02	1.0873E-02	2.0411E-04	9.8813E-05	8.802
+/- ^l	NA	4.2081E-05	3.9587E-04	4.1449E-04	4.1885E-04	3.8101E-04	2.0233E-04	1.111
Segment Total								
+/- ⁿ								
tot U ^c	0.00015	0.5537	6.59757	7.53452	8.21244	6.80373	4.70536	4.6
+/- ^c	0.00008	0.00014	0.00183	0.00549	0.00234	0.00193	0.00114	0.0
Kr-82 (mol%) ^d	0.2	0.2	0.2	0.2	0.2	0.2	0.2	
+/- ^d	0.1	0.1	0.1	0.1	0.1	0.1	0.1	
Kr-82 (g) ^k	4.9148E-07	0.0000E+00	1.1788E-04	2.8961E-04	3.9549E-04	2.3680E-04	1.4257E-04	1.462
+/- ^j	2.4574E-07	NA	7.0761E-05	1.5215E-04	2.0165E-04	1.2127E-04	7.4124E-05	7.533
Segment Total								
+/- ⁿ								
Kr-83 (mol%) ^d	14.7	14.7	14.7	14.7	14.7	14.7	14.7	
+/- ^d	0.1	0.1	0.1	0.1	0.1	0.1	0.1	
Kr-83 (g) ^k	3.6565E-05	0.0000E+00	8.7702E-03	2.1546E-02	2.9423E-02	1.7617E-02	1.0607E-02	1.087
+/- ^j	2.4874E-07	NA	2.9136E-03	3.4768E-03	2.9443E-03	1.9539E-03	1.5131E-03	1.355
Segment Total								
+/- ⁿ								
Kr-84 (mol%) ^d	30.6	30.6	30.6	30.6	30.6	30.6	30.6	
+/- ^d	0.1	0.1	0.1	0.1	0.1	0.1	0.1	
Kr-84 (g) ^k	7.7031E-05	0.0000E+00	1.8476E-02	4.5391E-02	6.1985E-02	3.7114E-02	2.2345E-02	2.291
+/- ^j	2.5173E-07	NA	6.1371E-03	7.3195E-03	6.1916E-03	4.1103E-03	3.1849E-03	2.851
Segment Total								
+/- ⁿ								

Rod "J" 1200830 (SBI-3 A49)

	J-00	J-01	J-02	J-03	J-04	J-05	J-06	J-07
seg length (in) ^a	11.319	11.439	14.242	14.043	14.133	13.913	10.498	
total length (in)								
Kr-85 (mol%) ^d	6	6	6	6	6	6	6	6
+/- ^d	0.1	0.1	0.1	0.1	0.1	0.1	0.1	0.1
Kr-85 (g) ^k	1.5284E-05	0.0000E+00	3.6659E-03	9.0064E-03	1.2299E-02	7.3641E-03	4.4337E-03	4.54
+/- ^j	2.5474E-07	NA	1.2192E-03	1.4598E-03	1.2449E-03	8.2438E-04	6.3608E-04	5.70
Segment Total								
+/- ⁿ								
Kr-86 (mol%) ^d	48.6	48.6	48.6	48.6	48.6	48.6	48.6	48.6
+/- ^d	0.2	48.6	48.6	48.6	48.6	48.6	48.6	48.6
Kr-86 (g) ^k	1.2526E-04	0.0000E+00	3.0043E-02	7.3809E-02	1.0079E-01	6.0350E-02	3.6335E-02	3.72
+/- ^j	5.1546E-07	NA	3.1657E-02	7.4762E-02	1.0129E-01	6.0719E-02	3.6702E-02	3.75
Segment Total								
+/- ⁿ								
Rod Total								
+/- ⁿ								
shear gas (g) ^e	0	0	0.001	0.0029	0.0041	0.0037	0.0024	
+/- ^e	0	0.0003	0.0003	0.0006	0.0008	0.0007	0.0005	
moles Kr (diss+pl) ^d	0.000003	0	0.000718	0.001763	0.002407	0.00144	0.000866	0
+/- ^d	0	0	0.000239	0.000285	0.000241	0.00016	0.000124	0
Kr+Xe diss&pl (g) ^d	0.0016	0.0099	0.4625	1.0696	1.4004	0.9815	0.4887	
+/- ^d	0	0.0099	0.0829	0.1727	0.115	0.1439	0.0509	
moles kr (tot) ^o	3.0000E-06	0.0000E+00	7.1955E-04	1.7678E-03	2.4140E-03	1.4454E-03	8.7025E-04	8.92
+/- ^p	0	0.0000E+00	2.3900E-04	2.8500E-04	2.4101E-04	1.6001E-04	1.2401E-04	1.11
Xe-128 (mol%) ^d	0.1	0.1	0.1	0.1	0.1	0.1	0.1	0.1
+/- ^d	0	0	0	0	0	0	0	0
Xe-128 (g) ^k	1.2790E-06	9.4649E-06	3.8326E-04	8.7851E-04	1.1423E-03	8.2141E-04	3.9742E-04	4.13
+/- ^j	0.0000E+00	9.4649E-06	7.6487E-05	1.4146E-04	1.0540E-04	1.3635E-04	4.7455E-05	2.85
SegmentTotal								
+/- ⁿ								

Rod "J" 1200830 (SBI-3 A49)

	J-00	J-01	J-02	J-03	J-04	J-05	J-06	J-07
seg length (in) ^a	11.319	11.439	14.242	14.043	14.133	13.913	10.498	1
total length (in)								
Xe-130 (mol%) ^d	0.2	0.2	0.2	0.2	0.2	0.2	0.2	0.2
+/- ^d	0	0	0	0	0	0	0	0
Xe-130 (g) ^k	2.5981E-06	1.9226E-05	7.7850E-04	1.7845E-03	2.3204E-03	1.6685E-03	8.0727E-04	8.404
+/- ^j	0.0000E+00	1.9226E-05	1.5537E-04	2.8735E-04	2.1409E-04	2.7696E-04	9.6394E-05	5.793
SegmentTotal								
+/- ⁿ								
Xe-131 (mol%) ^d	10.6	10.6	10.6	10.6	10.6	10.6	10.6	10.6
+/- ^d	0.1	0.1	0.1	0.1	0.1	0.1	0.1	0.1
Xe-131 (g) ^k	1.3876E-04	1.0268E-03	4.1579E-02	9.5308E-02	1.2393E-01	8.9113E-02	4.3115E-02	4.488
+/- ^j	1.3091E-06	1.0269E-03	8.3072E-03	1.5373E-02	1.1494E-02	1.4816E-02	5.1643E-03	3.123
SegmentTotal								
+/- ⁿ								
Xe-132 (mol%) ^d	22.3	22.3	22.3	22.3	22.3	22.3	22.3	22.3
+/- ^d	0.1	0.1	0.1	0.1	0.1	0.1	0.1	0.1
Xe-132 (g) ^k	2.9415E-04	2.1767E-03	8.8140E-02	2.0204E-01	2.6270E-01	1.8890E-01	9.1397E-02	9.515
+/- ^j	1.3190E-06	2.1767E-03	1.7595E-02	3.2546E-02	2.4267E-02	3.1368E-02	1.0921E-02	6.573
SegmentTotal								
+/- ⁿ								
Xe-134 (mol%) ^d	24.7	24.7	24.7	24.7	24.7	24.7	24.7	24.7
+/- ^d	0.1	0.1	0.1	0.1	0.1	0.1	0.1	0.1
Xe-134 (g) ^k	3.3075E-04	2.4475E-03	9.9107E-02	2.2718E-01	2.9539E-01	2.1241E-01	1.0277E-01	1.069
+/- ^j	1.3391E-06	2.4475E-03	1.9783E-02	3.6593E-02	2.7280E-02	3.5269E-02	1.2278E-02	7.388
SegmentTotal								
+/- ⁿ								

B-54

Rod "J" 1200830 (SBI-3 A49)

	J-00	J-01	J-02	J-03	J-04	J-05	J-06	J-07
seg length (in) ^a	11.319	11.439	14.242	14.043	14.133	13.913	10.498	
total length (in)								
Xe-136 (mol%) ^d	42.1	42.1	42.1	42.1	42.1	42.1	42.1	
+/- ^d	0.1	0.1	0.1	0.1	0.1	0.1	0.1	
Xe-136 (g) ^k	5.7217E-04	4.2341E-03	1.7145E-01	3.9300E-01	5.1101E-01	3.6745E-01	1.7778E-01	1.85
+/- ^l	1.3591E-06	4.2341E-03	3.4218E-02	6.3290E-02	4.7164E-02	6.1001E-02	2.1233E-02	1.27
SegmentTotal								
+/- ⁿ								
Rod total								
+/- ⁿ								
shear gas (g) ^e	0	0	0.001	0.0029	0.0041	0.0037	0.0024	
+/- ^e	0	0.0003	0.0003	0.0006	0.0008	0.0007	0.0005	
moles Xe (diss+pl) ^d	0.00001	0.000074	0.00299	0.00685	0.008905	0.006398	0.003092	0.
+/- ^d	0	0.000074	0.000598	0.001106	0.000824	0.001066	0.000371	0.
Kr+Xe diss&pl (g) ^d	0.0016	0.0099	0.4625	1.0696	1.4004	0.9815	0.4887	
+/- ^d	0	0.0099	0.0829	0.1727	0.115	0.1439	0.0509	
moles Xe (tot) ^o	1.0000E-05	7.4000E-05	2.9965E-03	6.8686E-03	8.9311E-03	6.4221E-03	3.1072E-03	3.23
+/- ^p	0.0000E+00	7.4000E-05	5.9801E-04	1.1060E-03	8.2402E-04	1.0660E-03	3.7102E-04	2.23
Values corrected to 1/1/84 (page 181, Final Report for the LWBR Proof of Breeding Analytical Support Project)								
Cs-137 (atoms) ^f	NA	7.9560E+18	4.7870E+20	1.0570E+21	1.4330E+21	9.5010E+20	5.7340E+20	3.92
+/- ^f	NA	3.0260E+16	1.7590E+18	3.3690E+18	5.1170E+18	3.4210E+18	2.0630E+18	1.40
Cs-137 (g) ^m	NA	1.8085E-03	1.0882E-01	2.4027E-01	3.2574E-01	2.1597E-01	1.3034E-01	8.91
+/- ^m	NA	6.8785E-06	3.9985E-04	7.6582E-04	1.1632E-03	7.7764E-04	4.6895E-04	3.18
Total								
+/- ⁿ								
Ce-144 (atoms) ^g	NA	9.4980E+17	3.2740E+19	5.9000E+19	7.5920E+19	6.4530E+19	3.7170E+19	2.26
+/- ^g	NA	6.8400E+15	2.3930E+17	3.8520E+17	5.4560E+17	4.6480E+17	2.6760E+17	1.63
Ce-144 (g) ^m	NA	2.2695E-04	7.8231E-03	1.4098E-02	1.8141E-02	1.5419E-02	8.8817E-03	5.41
+/- ^m	NA	1.6344E-06	5.7180E-05	9.2043E-05	1.3037E-04	1.1106E-04	6.3942E-05	3.89
Total								
+/- ⁿ								

B-55

Rod "J" 1200830 (SBI-3 A49)

	J-00	J-01	J-02	J-03	J-04	J-05	J-06	J-07
seg length (in) ^a	11.319	11.439	14.242	14.043	14.133	13.913	10.498	
total length (in)								
Zr-95 (atoms) ^h	NA	9.4020E+15	3.0250E+17	4.6690E+17	5.8520E+17	4.9840E+17	2.2260E+17	8.82
+/- ⁿ	NA	1.9670E+14	1.0230E+16	2.0470E+16	2.8950E+16	1.4380E+16	1.0920E+16	6.71
Zr-95 (g) ^m	NA	1.4816E-06	4.7668E-05	7.3575E-05	9.2216E-05	7.8538E-05	3.5078E-05	1.39
+/- ^m	NA	3.0996E-08	1.6121E-06	3.2257E-06	4.5620E-06	2.2660E-06	1.7208E-06	1.05
Total								
+/- ⁿ								

Footnotes

- a. ANL Destructive Chemical Assay of 33-Rod LWBR EOL Sample - Rod J, 1200830, page 3
- b. ANL Destructive Chemical Assay of 33-Rod LWBR EOL Sample - Rod J, 1200830, page 6
- c. ANL Destructive Chemical Assay of 33-Rod LWBR EOL Sample - Rod J, 1200830, page 7
- d. ANL Destructive Chemical Assay of 33-Rod LWBR EOL Sample - Rod J, 1200830, page 10
- e. ANL Destructive Chemical Assay of 33-Rod LWBR EOL Sample - Rod J, 1200830, page 11
- f. ANL Destructive Chemical Assay of 33-Rod LWBR EOL Sample - Rod J, 1200830, page 12
- g. ANL Destructive Chemical Assay of 33-Rod LWBR EOL Sample - Rod J, 1200830, page 13
- h. ANL Destructive Chemical Assay of 33-Rod LWBR EOL Sample - Rod J, 1200830, page 14
- i. (abundance of the specified isotope)(total weight of uranium) / 100
- j. Error Propagation = $((sd_x/x)^2 + (sd_y/y)^2)^{1/2}(xy)$, where sd is the +/- in the table
- k. (mole%)(number moles gas recovered)(molec wt) / 100
- m. (number of atoms per segment)(atomic weight) / 6.0228E+23
- n. Error Propagation = $(SUM(sd_i^2))^{1/2}$, where sd is the +/- in the table
- o. $((shear\ gas / Xe + Kr\ (diss\ \&\ pl)))(moles\ Xe\ or\ Kr\ (diss + pl)) + moles\ Xe\ or\ Kr\ (diss + pl)$
- p. Error Propagation = $(((((sd_x/x)^2 + (sd_y/y)^2 + (sd_z/z)^2)^{1/2} (xy/z))^2 + (sd_y)^2)^{1/2}$, where sd is the +/- in the table

Rod "K" 1302864 (SBI-3 D24)

	K-00	K-01	K-02	K-03	K-04	K-05	K-06	K-07
seg length (in) ^a	11.38	8.308	14.235	14.034	14.034	14.019	14.135	1
total length (in)								
U-232 wt% ^b	0	0.0128	0.0291	0.1049	0.1592	0.1676	0.133	0
+/- ^b	0	0.0004	0.0009	0.0032	0.0049	0.0052	0.0041	0
U-232 g ⁱ	0.0000E+00	5.8481E-05	2.7294E-03	9.9356E-03	1.5410E-02	1.6117E-02	1.2302E-02	3.544
+/- ^j	NA	1.8276E-06	8.4417E-05	3.0310E-04	4.7433E-04	5.0006E-04	3.7925E-04	1.109
Segment Total								
+/- ⁿ								
U-233 wt% ^b	100	98.3699	94.4057	89.9048	87.363	86.6543	87.5838	94
+/- ^b	0	0.0138	0.0055	0.0064	0.0063	0.007	0.0064	0
U-233 g ⁱ	4.0000E-05	4.4943E-01	8.8547E+00	8.5154E+00	8.4566E+00	8.3328E+00	8.1012E+00	2.4410
+/- ^j	1.0000E-05	1.4258E-04	2.3790E-03	2.3801E-03	2.1584E-03	2.2934E-03	2.2091E-03	7.773
Segment Total								
+/- ⁿ								
U-234 wt% ^b	0	1.4383	4.7304	8.3343	10.2387	10.7721	10.1038	4
+/- ^b	0	0.0007	0.0007	0.0009	0.001	0.0012	0.0011	0
U-234 g ⁱ	0.0000E+00	6.5713E-03	4.4368E-01	7.8939E-01	9.9109E-01	1.0359E+00	9.3456E-01	1.220
+/- ^j	NA	3.7046E-06	1.3361E-04	2.2976E-04	2.6125E-04	2.9596E-04	2.6577E-04	4.187
Segment Total								
+/- ⁿ								
U-235 wt% ^b	0	0.0848	0.5397	1.3262	1.8664	2.0106	1.8017	0
+/- ^b	0	0.01	0.0041	0.0045	0.0037	0.0043	0.0042	0
U-235 g ⁱ	0.0000E+00	3.8743E-04	5.0621E-02	1.2561E-01	1.8066E-01	1.9334E-01	1.6665E-01	1.256
+/- ^j	NA	4.5688E-05	3.8478E-04	4.2757E-04	3.6087E-04	4.1661E-04	3.9094E-04	1.883
Segment Total								
+/- ⁿ								
U-236 wt% ^b	0	0.0131	0.0601	0.1188	0.1789	0.1986	0.1706	0
+/- ^b	0	0.0001	0.0001	0.0001	0.0001	0.0001	0.0001	0
U-236 g ⁱ	0.0000E+00	5.9851E-05	5.6370E-03	1.1252E-02	1.7317E-02	1.9098E-02	1.5780E-02	4.695
+/- ^j	NA	4.5720E-07	9.4952E-06	9.9478E-06	1.0568E-05	1.0850E-05	1.0136E-05	2.583
Segment Total								
+/- ⁿ								

B-57

Rod "K" 1302864 (SBI-3 D24)

	K-00	K-01	K-02	K-03	K-04	K-05	K-06	K-07
seg length (in) ^a	11.38	8.308	14.235	14.034	14.034	14.019	14.135	14.019
total length (in)								
U-238 wt% ^b	0	0.0811	0.2349	0.211	0.1938	0.1967	0.2071	0.2071
+/- ^b	0	0.0098	0.0039	0.0044	0.0036	0.0042	0.0041	0.0041
U-238 g ^l	0.0000E+00	3.7053E-04	2.2032E-02	1.9985E-02	1.8759E-02	1.8915E-02	1.9156E-02	1.0577E-01
+/- ^l	NA	4.4774E-05	3.6584E-04	4.1678E-04	3.4850E-04	4.0391E-04	3.7927E-04	1.8577E-03
Segment Total								
+/- ⁿ								
tot U ^c	0.00236	0.45688	9.37938	9.47154	9.67982	9.61619	9.24963	2.91477
+/- ^c	0.00002	0.00013	0.00246	0.00256	0.00237	0.00253	0.00243	0.00243
Kr-82 (mol%) ^d	0.2	0.2	0.2	0.2	0.2	0.2	0.2	0.2
+/- ^d	0.1	0.1	0.1	0.1	0.1	0.1	0.1	0.1
Kr-82 (g) ^k	4.9148E-07	1.8878E-07	1.2123E-04	2.6573E-04	3.3803E-04	3.9079E-04	3.8142E-04	4.5747E-04
+/- ^j	1.5171E-05	NA	6.2459E-05	1.3518E-04	1.7192E-04	1.9890E-04	1.9412E-04	2.4647E-04
Segment Total								
+/- ⁿ								
Kr-83 (mol%) ^d	15.6	15.6	15.6	15.6	15.6	15.6	15.6	15.6
+/- ^d	0.1	0.1	0.1	0.1	0.1	0.1	0.1	0.1
Kr-83 (g) ^k	3.8804E-05	1.4904E-05	9.5711E-03	2.0980E-02	2.6688E-02	3.0854E-02	3.0114E-02	3.6114E-02
+/- ^j	1.1976E-03	NA	1.1916E-03	1.9707E-03	2.4894E-03	2.9428E-03	2.8651E-03	7.2477E-03
Segment Total								
+/- ⁿ								
Kr-84 (mol%) ^d	29.8	29.8	29.8	29.8	29.8	29.8	29.8	29.8
+/- ^d	0.1	0.1	0.1	0.1	0.1	0.1	0.1	0.1
Kr-84 (g) ^k	7.5017E-05	2.8814E-05	1.8503E-02	4.0560E-02	5.1595E-02	5.9647E-02	5.8218E-02	6.9817E-02
+/- ^j	2.3153E-03	NA	2.3014E-03	3.8033E-03	4.8043E-03	5.6798E-03	5.5297E-03	1.4000E-02
Segment Total								
+/- ⁿ								

B-58

Rod "K" 1302864 (SBI-3 D24)

	K-00	K-01	K-02	K-03	K-04	K-05	K-06	K-07
seg length (in) ^a	11.38	8.308	14.235	14.034	14.034	14.019	14.135	14.135
total length (in)								
Kr-85 (mol%) ^d	5.8	5.8	5.8	5.8	5.8	5.8	5.8	5.8
+/- ^d	0.1	0.1	0.1	0.1	0.1	0.1	0.1	0.1
Kr-85 (g) ^k	1.4775E-05	5.6749E-06	3.6442E-03	7.9883E-03	1.0162E-02	1.1748E-02	1.1466E-02	1.375E-02
+/- ^j	4.5601E-04	NA	4.5744E-04	7.6116E-04	9.6169E-04	1.1362E-03	1.1062E-03	2.768E-03
Segment Total								
+/- ⁿ								
Kr-86 (mol%) ^d	48.6	48.6	48.6	48.6	48.6	48.6	48.6	48.6
+/- ^d	0.1	0.1	0.1	0.1	0.1	0.1	0.1	0.1
Kr-86 (g) ^k	1.2526E-04	4.8111E-05	3.0895E-02	6.7723E-02	8.6150E-02	9.9595E-02	9.7208E-02	1.165E-01
+/- ^j	3.8660E-03	NA	3.8418E-03	6.3480E-03	8.0186E-03	9.4801E-03	9.2296E-03	2.338E-02
Segment Total								
+/- ⁿ								
Rod Total								
+/- ⁿ								
shear gas (g) ^e	0	0.0006	0.0005	0.0017	0.0024	0.002	0.0018	0
+/- ^e	0	0.0003	0.0003	0.0003	0.0005	0.0004	0.0004	0
moles Kr (diss+pl) ^d	0.000003	0	0.000739	0.001619	0.002059	0.002382	0.002325	0.002325
+/- ^d	0	0	0.000092	0.000152	0.000192	0.000227	0.000221	0.000221
Kr+Xe diss&pl (g) ^d	0.0018	0	0.3848	0.9115	1.1391	1.42	1.3119	1.3119
+/- ^d	0.0001	0	0.032	0.0558	0.1296	0.0786	0.1498	0.1498
moles kr (tot) ^o	3.0000E-06	1.1523E-06	7.3996E-04	1.6220E-03	2.0633E-03	2.3854E-03	2.3282E-03	2.792E-03
+/- ^p	9.2593E-05	6.0142E-07	9.2002E-05	1.5200E-04	1.9200E-04	2.2700E-04	2.2100E-04	5.600E-04
Xe-128 (mol%) ^d	0.1	0.1	0.1	0.1	0.1	0.1	0.1	0.1
+/- ^d	0	0	0	0	0	0	0	0
Xe-128 (g) ^k	1.4069E-06	4.7864E-07	3.0737E-04	7.3900E-04	9.2079E-04	1.1621E-03	1.0636E-03	1.071E-03
+/- ^j	8.3276E-05	2.4694E-07	2.9547E-05	5.1802E-05	1.2253E-04	7.2522E-05	1.4159E-04	1.432E-04
SegmentTotal								
+/- ⁿ								

B-59

Rod "K" 1302864 (SBI-3 D24)

	K-00	K-01	K-02	K-03	K-04	K-05	K-06	K-07
seg length (in) ^a	11.38	8.308	14.235	14.034	14.034	14.019	14.135	1
total length (in)								
Xe-130 (mol%) ^d	0.2	0.2	0.2	0.2	0.2	0.2	0.2	0.2
+/- ^d	0	0	0	0	0	0	0	0
Xe-130 (g) ^k	2.8579E-06	9.7225E-07	6.2435E-04	1.5011E-03	1.8704E-03	2.3605E-03	2.1604E-03	2.176E-03
+/- ^j	1.6916E-04	5.0161E-07	6.0017E-05	1.0522E-04	2.4890E-04	1.4731E-04	2.8761E-04	2.910E-04
SegmentTotal								
+/- ⁿ								
Xe-131 (mol%) ^d	11.8	11.8	11.8	11.8	11.8	11.8	11.8	11.8
+/- ^d	0.1	0.1	0.1	0.1	0.1	0.1	0.1	0.1
Xe-131 (g) ^k	1.6991E-04	5.7805E-05	3.7120E-02	8.9248E-02	1.1120E-01	1.4035E-01	1.2845E-01	1.293E-01
+/- ^j	1.0057E-02	2.9827E-05	3.5822E-03	6.3016E-03	1.4828E-02	8.8388E-03	1.7134E-02	1.733E-02
SegmentTotal								
+/- ⁿ								
Xe-132 (mol%) ^d	22.7	22.7	22.7	22.7	22.7	22.7	22.7	22.7
+/- ^d	0.1	0.1	0.1	0.1	0.1	0.1	0.1	0.1
Xe-132 (g) ^k	3.2936E-04	1.1205E-04	7.1955E-02	1.7300E-01	2.1556E-01	2.7205E-01	2.4898E-01	2.508E-01
+/- ^j	1.9495E-02	5.7812E-05	6.9242E-03	1.2151E-02	2.8701E-02	1.7020E-02	3.3164E-02	3.355E-02
SegmentTotal								
+/- ⁿ								
Xe-134 (mol%) ^d	25.8	25.8	25.8	25.8	25.8	25.8	25.8	25.8
+/- ^d	0.1	0.1	0.1	0.1	0.1	0.1	0.1	0.1
Xe-134 (g) ^k	3.8002E-04	1.2928E-04	8.3022E-02	1.9961E-01	2.4871E-01	3.1389E-01	2.8728E-01	2.893E-01
+/- ^j	2.2493E-02	6.6703E-05	7.9873E-03	1.4013E-02	3.3111E-02	1.9626E-02	3.8261E-02	3.871E-02
SegmentTotal								
+/- ⁿ								

B-60

Rod "K" 1302864 (SBI-3 D24)

	K-00	K-01	K-02	K-03	K-04	K-05	K-06	K-07
seg length (in) ^a	11.38	8.308	14.235	14.034	14.034	14.019	14.135	10.4
total length (in)								
Xe-136 (mol%) ^d	39.4	39.4	39.4	39.4	39.4	39.4	39.4	39.4
+/- ^d	0.1	0.1	0.1	0.1	0.1	0.1	0.1	0.1
Xe-136 (g) ^k	5.8902E-04	2.0039E-04	1.2868E-01	3.0938E-01	3.8550E-01	4.8652E-01	4.4527E-01	4.4852E-01
+/- ^j	3.4864E-02	1.0339E-04	1.2374E-02	2.1701E-02	5.1308E-02	3.0387E-02	5.9288E-02	5.9992E-02
SegmentTotal								
+/- ⁿ								
Rod total								
+/- ⁿ								
shear gas (g) ^e	0	0.0006	0.0005	0.0017	0.0024	0.002	0.0018	0.0018
+/- ^e	0	0.0003	0.0003	0.0003	0.0005	0.0004	0.0004	0.0004
moles Xe (diss+pl) ^d	0.000011	0	0.0024	0.005767	0.007184	0.009073	0.008304	0.008304
+/- ^d	0.000001	0	0.000231	0.000405	0.000958	0.000567	0.001107	0.001107
Kr+Xe diss&pl (g) ^d	0.0018	0	0.3848	0.9115	1.1391	1.42	1.3119	1.3119
+/- ^d	0.0001	0	0.032	0.0558	0.1296	0.0786	0.1498	0.1498
moles Xe (tot) ^o	1.1000E-05	3.7422E-06	2.4031E-03	5.7778E-03	7.1991E-03	9.0858E-03	8.3154E-03	8.3762E-03
+/- ^p	6.5108E-04	1.9307E-06	2.3101E-04	4.0501E-04	9.5801E-04	5.6701E-04	1.1070E-03	1.1202E-03
Values corrected to 1/1/84 (page 181, Final Report for the LWBR Proof of Breeding Analytical Support Project)								
Cs-137 (atoms) ^f	NA	6.2820E+18	4.2230E+20	9.1210E+20	1.2080E+21	1.2810E+21	1.1440E+21	1.3930E+21
+/- ^f	NA	2.2020E+16	1.4210E+18	2.9660E+18	3.9320E+18	4.1660E+18	3.7150E+18	4.7270E+18
Cs-137 (g) ^m	NA	1.4280E-03	9.5995E-02	2.0733E-01	2.7460E-01	2.9119E-01	2.6005E-01	3.1665E-01
+/- ^m	NA	5.0055E-06	3.2301E-04	6.7421E-04	8.9380E-04	9.4699E-04	8.4447E-04	1.0745E-03
Total								
+/- ⁿ								
Ce-144 (atoms) ^g	NA	6.7410E+17	2.9070E+19	4.9780E+19	6.1220E+19	6.4670E+19	5.0810E+19	8.0980E+19
+/- ^g	NA	3.8260E+15	1.6890E+17	2.8160E+17	3.4650E+17	3.6580E+17	2.8730E+17	5.0540E+17
Ce-144 (g) ^m	NA	1.6107E-04	6.9462E-03	1.1895E-02	1.4628E-02	1.5453E-02	1.2141E-02	1.9350E-02
+/- ^m	NA	9.1421E-07	4.0358E-05	6.7288E-05	8.2795E-05	8.7407E-05	6.8650E-05	1.2076E-04
Total								
+/- ⁿ								

B-61

Rod "K" 1302864 (SBI-3 D24)

	K-00	K-01	K-02	K-03	K-04	K-05	K-06	K-07
seg length (in) ^a	11.38	8.308	14.235	14.034	14.034	14.019	14.135	
total length (in)								
Zr-95 (atoms) ^h	NA	6.7480E+15	2.5440E+17	4.1470E+17	4.2840E+17	4.4320E+17	2.5090E+17	2.94
+/- ⁿ	NA	1.4920E+14	7.0750E+15	1.6760E+16	2.6570E+16	2.3570E+16	2.0430E+16	3.44
Zr-95 (g) ^m	NA	1.0634E-06	4.0089E-05	6.5349E-05	6.7508E-05	6.9840E-05	3.9537E-05	4.6
+/- ^m	NA	2.3511E-08	1.1149E-06	2.6411E-06	4.1869E-06	3.7142E-06	3.2194E-06	5.4
Total								
+/- ⁿ								

Footnotes

- a. ANL Destructive Chemical Assay of 33-Rod LWBR EOL Sample - Rod K, 1302864, page 3
- b. ANL Destructive Chemical Assay of 33-Rod LWBR EOL Sample - Rod K, 1302864, page 6
- c. ANL Destructive Chemical Assay of 33-Rod LWBR EOL Sample - Rod K, 1302864, page 7
- d. ANL Destructive Chemical Assay of 33-Rod LWBR EOL Sample - Rod K, 1302864, page 10
- e. ANL Destructive Chemical Assay of 33-Rod LWBR EOL Sample - Rod K, 1302864, page 11
- f. ANL Destructive Chemical Assay of 33-Rod LWBR EOL Sample - Rod K, 1302864, page 12
- g. ANL Destructive Chemical Assay of 33-Rod LWBR EOL Sample - Rod K, 1302864, page 13
- h. ANL Destructive Chemical Assay of 33-Rod LWBR EOL Sample - Rod K, 1302864, page 14
- i. (abundance of the specified isotope)(total weight of uranium) / 100
- j. Error Propagation = $((sd_x/x)^2 + (sd_y/y)^2)^{1/2}(xy)$, where sd is the +/- in the table
- k. (mole%)(number moles gas recovered)(molec wt) / 100
- m. (number of atoms per segment)(atomic weight) / 6.0228E+23
- n. Error Propagation = $(SUM(sd_i^2))^{1/2}$, where sd is the +/- in the table
- o. ((shear gas / Xe + Kr (diss&pl)))(moles Xe or Kr (diss + pl)) + moles Xe or Kr (diss + pl)
- p. Error Propagation = $(((((sd_x/x)^2 + (sd_y/y)^2 + (sd_z/z)^2)^{1/2} (xy/z))^2 + (sd_y)^2)^{1/2}$, where sd is the +/- in the table

Rod "L" 1400544 (SBI-3 C3)

	L-00	L-01	L-02	L-03	L-04	L-05	L-06	L-07
seg length (in) ^a	11.176	11.007	14.373	14.172	14.17	14.25	13.927	1
total length (in)								
U-232 wt% ^b	0	0.0143	0.0336	0.1192	0.1774	0.1849	0.2232	
+/- ^b	0	0.0004	0.001	0.0037	0.0055	0.0057	0.0069	0
U-232 g ⁱ	0.0000E+00	5.3335E-05	2.7665E-03	1.0328E-02	1.6010E-02	1.6521E-02	1.1600E-02	3.574
+/- ^j	NA	1.4920E-06	8.2341E-05	3.2060E-04	4.9638E-04	5.0932E-04	3.5860E-04	1.101
Segment Total								
+/- ⁿ								
U-233 wt% ^b	100	99.1263	94.4905	89.8566	87.2258	86.2043	91.2627	94
+/- ^b	0	0.0165	0.0072	0.0069	0.0078	0.0078	0.0083	0
U-233 g ⁱ	4.0000E-05	3.6971E-01	7.7800E+00	7.7855E+00	7.8718E+00	7.7023E+00	4.7429E+00	2.5325
+/- ^j	1.0000E-05	1.4280E-04	2.3989E-03	2.3420E-03	2.4748E-03	2.3966E-03	1.2538E-03	7.433
Segment Total								
+/- ⁿ								
U-234 wt% ^b	0	0.8088	4.7282	8.4153	10.371	11.1056	7.3494	5
+/- ^b	0	0.001	0.001	0.0012	0.0014	0.0014	0.0011	
U-234 g ⁱ	0.0000E+00	3.0166E-03	3.8930E-01	7.2913E-01	9.3595E-01	9.9228E-01	3.8195E-01	1.358
+/- ^j	NA	3.8751E-06	1.4251E-04	2.3618E-04	3.0909E-04	3.2080E-04	1.1071E-04	4.687
Segment Total								
+/- ⁿ								
U-235 wt% ^b	0	0.0168	0.4773	1.3112	1.8817	2.1282	1.0983	0
+/- ^b	0	0.0118	0.0055	0.0048	0.005	0.005	0.0043	0
U-235 g ⁱ	0.0000E+00	6.2659E-05	3.9299E-02	1.1361E-01	1.6982E-01	1.9015E-01	5.7078E-02	1.481
+/- ^j	NA	4.4010E-05	4.5300E-04	4.1720E-04	4.5413E-04	4.5032E-04	2.2392E-04	1.290
Segment Total								
+/- ⁿ								
U-236 wt% ^b	0	0.0002	0.025	0.0877	0.1539	0.1868	0.0646	0
+/- ^b	0	0.0001	0.0001	0.0001	0.0001	0.0001	0.0001	0
U-236 g ⁱ	0.0000E+00	7.4594E-07	2.0584E-03	7.5987E-03	1.3889E-02	1.6690E-02	3.3572E-03	5.858
+/- ^j	NA	3.7297E-07	8.2566E-06	8.9418E-06	9.9483E-06	1.0224E-05	5.2634E-06	2.692
Segment Total								
+/- ⁿ								

B-63

Rod "L" 1400544 (SBI-3 C3)

	L-00	L-01	L-02	L-03	L-04	L-05	L-06	L-07
seg length (in) ^a	11.176	11.007	14.373	14.172	14.17	14.25	13.927	1
total length (in)								
U-238 wt% ^b	0	0.0336	0.2453	0.2101	0.1904	0.1902	0.0019	0
+/- ^b	0	0.0116	0.0051	0.0044	0.0047	0.0047	0.0038	0
U-238 g ^l	0.0000E+00	1.2532E-04	2.0197E-02	1.8204E-02	1.7183E-02	1.6994E-02	9.8743E-05	7.256
+/- ^l	NA	4.3265E-05	4.1996E-04	3.8127E-04	4.2419E-04	4.1997E-04	1.9749E-04	1.182
Segment Total								
+/- ⁿ								
tot U ^c	0.00036	0.37297	8.23365	8.66438	9.02466	8.93494	5.19698	2.6
+/- ^c	0.00002	0.00013	0.00246	0.00252	0.00272	0.00266	0.00129	0.0
Kr-82 (mol%) ^d	0.1	0.1	0.1	0.1	0.1	0.1	0.1	
+/- ^d	0.1	0.1	0.1	0.1	0.1	0.1	0.1	
Kr-82 (g) ^k	3.2765E-07	0.0000E+00	5.7477E-05	1.3365E-04	1.7176E-04	1.5191E-04	7.0627E-05	2.486
+/- ^j	6.7776E-06	NA	5.7991E-05	1.3451E-04	1.7246E-04	1.5344E-04	7.1252E-05	2.536
Segment Total								
+/- ⁿ								
Kr-83 (mol%) ^d	15.2	15.2	15.2	15.2	15.2	15.2	15.2	
+/- ^d	0.2	0.2	0.2	0.2	0.2	0.2	0.2	
Kr-83 (g) ^k	5.0412E-05	0.0000E+00	8.8433E-03	2.0563E-02	2.6426E-02	2.3372E-02	1.0866E-02	3.825
+/- ^j	1.0416E-03	NA	1.1904E-03	2.3597E-03	2.4197E-03	3.3414E-03	1.4564E-03	7.704
Segment Total								
+/- ⁿ								
Kr-84 (mol%) ^d	30.1	30.1	30.1	30.1	30.1	30.1	30.1	
+/- ^d	0.2	0.2	0.2	0.2	0.2	0.2	0.2	
Kr-84 (g) ^k	1.0103E-04	0.0000E+00	1.7723E-02	4.1209E-02	5.2961E-02	4.6840E-02	2.1777E-02	7.666
+/- ^j	2.0874E-03	NA	2.3771E-03	4.7059E-03	4.8118E-03	6.6753E-03	2.9082E-03	1.541
Segment Total								
+/- ⁿ								

B-64

Rod "L" 1400544 (SBI-3 C3)

	L-00	L-01	L-02	L-03	L-04	L-05	L-06	L-07
seg length (in) ^a	11.176	11.007	14.373	14.172	14.17	14.25	13.927	10.0
total length (in)								
Kr-85 (mol%) ^d	5.4	5.4	5.4	5.4	5.4	5.4	5.4	5.4
+/- ^d	0.2	0.2	0.2	0.2	0.2	0.2	0.2	0.2
Kr-85 (g) ^k	1.8341E-05	0.0000E+00	3.2174E-03	7.4812E-03	9.6146E-03	8.5034E-03	3.9535E-03	1.3918E-03
+/- ^j	3.7895E-04	NA	4.4719E-04	8.9675E-04	9.4118E-04	1.2508E-03	5.4726E-04	2.8442E-04
Segment Total								
+/- ⁿ								
Kr-86 (mol%) ^d	49.2	49.2	49.2	49.2	49.2	49.2	49.2	49.2
+/- ^d	0.3	0.3	0.3	0.3	0.3	0.3	0.3	0.3
Kr-86 (g) ^k	1.6907E-04	0.0000E+00	2.9659E-02	6.8963E-02	8.8629E-02	7.8386E-02	3.6444E-02	1.2830E-02
+/- ^j	3.4932E-03	NA	3.9774E-03	7.8731E-03	8.0492E-03	1.1169E-02	4.8660E-03	2.5796E-03
Segment Total								
+/- ⁿ								
Rod Total								
+/- ⁿ								
shear gas (g) ^e	0	0	0.0004	0.0015	0.0022	0.0025	0.0007	0.0003
+/- ^e	0	0.0003	0.0003	0.0003	0.0004	0.0005	0.0003	0.0003
moles Kr (diss+pl) ^d	0.000004	0	0.000701	0.001629	0.002093	0.00185	0.000861	0.000303
+/- ^d	0	0	0.000094	0.000186	0.00019	0.000264	0.000115	0.000030
Kr+Xe diss&pl (g) ^d	0.0022	0	0.4112	0.9508	1.1996	1.0265	0.4973	0.1700
+/- ^d	0.0001	0	0.0324	0.0645	0.1288	0.0915	0.0473	0.0150
moles kr (tot) ^o	4.0000E-06	0	7.0168E-04	1.6316E-03	2.0968E-03	1.8545E-03	8.6221E-04	3.0353E-04
+/- ^p	8.2645E-05	0	9.4001E-05	1.8600E-04	1.9000E-04	2.6400E-04	1.1500E-04	6.1002E-05
Xe-128 (mol%) ^d	0.1	0.1	0.1	0.1	0.1	0.1	0.1	0.1
+/- ^d	0	0	0	0	0	0	0	0
Xe-128 (g) ^k	1.6627E-06	0.0000E+00	3.3531E-04	7.7517E-04	9.7526E-04	8.3019E-04	4.0462E-04	1.3979E-04
+/- ^j	6.7530E-05	NA	2.9930E-05	5.9476E-05	1.2164E-04	8.4546E-05	4.4127E-05	1.5478E-05
SegmentTotal								
+/- ⁿ								

B-65

Rod "L" 1400544 (SBI-3 C3)

	L-00	L-01	L-02	L-03	L-04	L-05	L-06	L-07
seg length (in) ^a	11.176	11.007	14.373	14.172	14.17	14.25	13.927	1
total length (in)								
Xe-130 (mol%) ^d	0.1	0.1	0.1	0.1	0.1	0.1	0.1	0.1
+/- ^d	0	0	0	0	0	0	0	0
Xe-130 (g) ^k	1.6887E-06	0.0000E+00	3.4055E-04	7.8729E-04	9.9051E-04	8.4317E-04	4.1094E-04	1.419
+/- ^j	6.8586E-05	NA	3.0398E-05	6.0406E-05	1.2354E-04	8.5868E-05	4.4817E-05	1.572
SegmentTotal								
+/- ⁿ								
Xe-131 (mol%) ^d	11.1	11.1	11.1	11.1	11.1	11.1	11.1	11.1
+/- ^d	0.1	0.1	0.1	0.1	0.1	0.1	0.1	0.1
Xe-131 (g) ^k	1.8890E-04	0.0000E+00	3.8092E-02	8.8063E-02	1.1079E-01	9.4314E-02	4.5966E-02	1.588
+/- ^j	7.6717E-03	NA	3.4175E-03	6.8032E-03	1.3855E-02	9.6423E-03	5.0302E-03	1.764
SegmentTotal								
+/- ⁿ								
Xe-132 (mol%) ^d	22.6	22.6	22.6	22.6	22.6	22.6	22.6	22.6
+/- ^d	0.1	0.1	0.1	0.1	0.1	0.1	0.1	0.1
Xe-132 (g) ^k	3.8753E-04	0.0000E+00	7.8149E-02	1.8067E-01	2.2730E-01	1.9349E-01	9.4303E-02	3.258
+/- ^j	1.5739E-02	NA	6.9844E-03	1.3885E-02	2.8368E-02	1.9724E-02	1.0293E-02	3.610
SegmentTotal								
+/- ⁿ								
Xe-134 (mol%) ^d	25.6	25.6	25.6	25.6	25.6	25.6	25.6	25.6
+/- ^d	0.2	0.2	0.2	0.2	0.2	0.2	0.2	0.2
Xe-134 (g) ^k	4.4564E-04	0.0000E+00	8.9866E-02	2.0775E-01	2.6138E-01	2.2250E-01	1.0844E-01	3.746
+/- ^j	1.8099E-02	NA	8.0524E-03	1.6023E-02	3.2664E-02	2.2726E-02	1.1857E-02	4.158
SegmentTotal								
+/- ⁿ								

B-66

Rod "L" 1400544 (SBI-3 C3)

	L-00	L-01	L-02	L-03	L-04	L-05	L-06	L-07
seg length (in) ^a	11.176	11.007	14.373	14.172	14.17	14.25	13.927	11.176
total length (in)								
Xe-136 (mol%) ^d	40.7	40.7	40.7	40.7	40.7	40.7	40.7	40.7
+/- ^d	0.2	0.2	0.2	0.2	0.2	0.2	0.2	0.2
Xe-136 (g) ^k	7.1909E-04	0.0000E+00	1.4501E-01	3.3523E-01	4.2177E-01	3.5903E-01	1.7498E-01	6.0453E-01
+/- ^j	2.9204E-02	NA	1.2964E-02	2.5774E-02	5.2645E-02	3.6606E-02	1.9103E-02	6.7009E-02
SegmentTotal								
+/- ⁿ								
Rod total								
+/- ⁿ								
shear gas (g) ^e	0	0	0.0004	0.0015	0.0022	0.0025	0.0007	0
+/- ^e	0	0.0003	0.0003	0.0003	0.0004	0.0005	0.0003	0
moles Xe (diss+pl) ^d	0.000013	0	0.002619	0.006051	0.007611	0.006475	0.003159	0.000013
+/- ^d	0.000001	0	0.000234	0.000465	0.000951	0.000661	0.000345	0.000001
Kr+Xe diss&pl (g) ^d	0.0022	0	0.4112	0.9508	1.1996	1.0265	0.4973	0
+/- ^d	0.0001	0	0.0324	0.0645	0.1288	0.0915	0.0473	0
moles Xe (tot) ^o	1.3000E-05	0	2.6215E-03	6.0605E-03	7.6250E-03	6.4908E-03	3.1634E-03	1.0929E-03
+/- ^p	5.2797E-04	0	2.3401E-04	4.6500E-04	9.5101E-04	6.6101E-04	3.4501E-04	1.2102E-04
Values corrected to 1/1/84 (page 181, Final Report for the LWBR Proof of Breeding Analytical Support Project)								
Cs-137 (atoms) ^f	NA	3.8080E+18	3.9250E+20	8.7130E+20	1.1660E+21	1.2680E+21	4.4470E+20	1.5580E+21
+/- ^f	NA	1.1990E+16	1.1260E+18	2.5000E+18	3.3460E+18	3.6350E+18	1.2750E+18	4.5260E+18
Cs-137 (g) ^m	NA	8.6561E-04	8.9221E-02	1.9806E-01	2.6505E-01	2.8823E-01	1.0109E-01	3.5416E-01
+/- ^m	NA	2.7255E-06	2.5596E-04	5.6829E-04	7.6059E-04	8.2629E-04	2.8983E-04	1.0288E-03
Total								
+/- ⁿ								
Ce-144 (atoms) ^g	NA	4.9060E+17	2.7450E+19	4.8590E+19	6.0730E+19	6.4920E+19	2.8980E+19	8.7540E+19
+/- ^g	NA	3.6290E+15	2.0270E+17	3.5880E+17	4.4850E+17	4.7940E+17	2.1400E+17	6.4770E+17
Ce-144 (g) ^m	NA	1.1723E-04	6.5591E-03	1.1610E-02	1.4511E-02	1.5512E-02	6.9247E-03	2.0917E-02
+/- ^m	NA	8.6714E-07	4.8435E-05	8.5734E-05	1.0717E-04	1.1455E-04	5.1135E-05	1.5477E-04
Total								
+/- ⁿ								

B-67

Rod "L" 1400544 (SBI-3 C3)

	L-00	L-01	L-02	L-03	L-04	L-05	L-06	L-07
seg length (in) ^a	11.176	11.007	14.373	14.172	14.17	14.25	13.927	11.176
total length (in)								
Zr-95 (atoms) ⁿ	NA	5.3870E+15	2.4560E+17	3.7340E+17	5.4680E+17	4.1920E+17	1.7670E+17	2.7740E+17
+/- ⁿ	NA	1.6110E+14	9.0000E+15	1.9010E+16	4.1060E+16	4.6580E+16	1.5310E+16	3.8210E+16
Zr-95 (g) ^m	NA	8.4889E-07	3.8702E-05	5.8841E-05	8.6165E-05	6.6058E-05	2.7845E-05	4.3713E-05
+/- ^m	NA	2.5386E-08	1.4182E-06	2.9956E-06	6.4703E-06	7.3401E-06	2.4126E-06	6.0212E-06
Total								
+/- ⁿ								

Footnotes

- a. ANL Destructive Chemical Assay of 33-Rod LWBR EOL Sample - Rod L, 1400544, page 3
- b. ANL Destructive Chemical Assay of 33-Rod LWBR EOL Sample - Rod L, 1400544, page 6
- c. ANL Destructive Chemical Assay of 33-Rod LWBR EOL Sample - Rod L, 1400544, page 7
- d. ANL Destructive Chemical Assay of 33-Rod LWBR EOL Sample - Rod L, 1400544, page 10
- e. ANL Destructive Chemical Assay of 33-Rod LWBR EOL Sample - Rod L, 1400544, page 11
- f. ANL Destructive Chemical Assay of 33-Rod LWBR EOL Sample - Rod L, 1400544, page 12
- g. ANL Destructive Chemical Assay of 33-Rod LWBR EOL Sample - Rod L, 1400544, page 13
- h. ANL Destructive Chemical Assay of 33-Rod LWBR EOL Sample - Rod L, 1400544, page 14
- i. (abundance of the specified isotope)(total weight of uranium) / 100
- j. Error Propagation = $((sd_x/x)^2 + (sd_y/y)^2)^{1/2}(xy)$, where sd is the +/- in the table
- k. (mole%)(number moles gas recovered)(molec wt) / 100
- m. (number of atoms per segment)(atomic weight) / 6.0228E+23
- n. Error Propagation = $(\sum(sd_i^2))^{1/2}$, where sd is the +/- in the table
- o. ((shear gas / Xe + Kr (diss&pl))(moles Xe or Kr (diss + pl)) + moles Xe or Kr (diss + pl)
- p. Error Propagation = $((((sd_x/x)^2 + (sd_y/y)^2 + (sd_z/z)^2)^{1/2}(xy/z))^2 + (sd_y)^2)^{1/2}$, where sd is the +/- in the table

Rod "M" 0504042 (SI-1, 5L29)

	M-00	M-01	M-02	M-03	M-04	M-05	M-06
seg length (in) ^a	10.078	10.088	21.438	21.24	21.24	21.308	9.9
total length (in)							
U-232 wt% ^b	0	0.042	0.0701	0.1417	0.1346	0.0437	0.0
+/- ^b	0	0.0013	0.0022	0.0044	0.0042	0.0014	0.0
U-232 g ⁱ	0.0000E+00	1.4414E-04	4.3676E-03	8.1992E-03	8.1110E-03	3.0991E-03	5.0054E-03
+/- ^j	NA	4.4617E-06	1.3708E-04	2.5461E-04	2.5310E-04	9.9286E-05	1.5828E-04
Segment Total							
+/- ⁿ							
U-233 wt% ^b	100	97.0789	87.5216	82.7315	84.0898	91.61	98.0
+/- ^b	0	0.0104	0.0061	0.0068	0.0066	0.0038	0.0
U-233 g ⁱ	4.0000E-05	3.3317E-01	5.4531E+00	4.7871E+00	5.0673E+00	6.4967E+00	1.9416E+00
+/- ^j	1.0000E-05	1.0343E-04	1.3920E-03	1.3255E-03	1.3708E-03	1.5715E-03	7.7653E-03
Segment Total							
+/- ⁿ							
U-234 wt% ^b	0	2.711	10.3344	13.8962	12.8481	7.0629	1.0
+/- ^b	0	0.0021	0.0019	0.0021	0.0018	0.0019	0.0
U-234 g ⁱ	0.0000E+00	9.3039E-03	6.4389E-01	8.0407E-01	7.7423E-01	5.0088E-01	3.4770E-01
+/- ^j	NA	7.7000E-06	1.9752E-04	2.4489E-04	2.2790E-04	1.8001E-04	4.5230E-04
Segment Total							
+/- ⁿ							
U-235 wt% ^b	0	0.1516	1.6115	2.6311	2.3806	0.92	0.0
+/- ^b	0	0.0073	0.0044	0.0046	0.0044	0.0023	0.0
U-235 g ⁱ	0.0000E+00	5.2028E-04	1.0040E-01	1.5224E-01	1.4346E-01	6.5243E-02	1.1969E-01
+/- ^j	NA	2.5053E-05	2.7525E-04	2.6920E-04	2.6773E-04	1.6385E-04	2.5719E-04
Segment Total							
+/- ⁿ							
U-236 wt% ^b	0	0.0035	0.1248	0.2597	0.2209	0.0575	0.0
+/- ^b	0	0.0001	0.0001	0.0001	0.0001	0.0001	0.0
U-236 g ⁱ	0.0000E+00	1.2012E-05	7.7757E-03	1.5027E-02	1.3312E-02	4.0777E-03	2.1762E-02
+/- ^j	NA	3.4321E-07	6.5165E-06	7.0192E-06	6.9418E-06	7.1579E-06	3.9568E-06
Segment Total							
+/- ⁿ							

Rod "M" 0504042 (SI-1, 5L29)

	M-00	M-01	M-02	M-03	M-04	M-05	M-06
seg length (in) ^a	10.078	10.088	21.438	21.24	21.24	21.308	
total length (in)							
U-238 wt% ^b	0	0.0129	0.3375	0.3397	0.326	0.3059	
+/- ^b	0	0.0074	0.0045	0.0047	0.0045	0.0024	
U-238 g ^j	0.0000E+00	4.4272E-05	2.1028E-02	1.9656E-02	1.9645E-02	2.1693E-02	3
+/- ^j	NA	2.5396E-05	2.8042E-04	2.7200E-04	2.7122E-04	1.7028E-04	2
Segment Total							
+/- ⁿ							
tot U ^c	0.00007	0.34319	6.23052	5.78628	6.02603	7.09168	
+/- ^c	0.00001	0.0001	0.00153	0.00153	0.00156	0.00169	
Kr-82 (mol%) ^d	0.2	0.2	0.2	0.2	0.2	0.2	
+/- ^d	0	0	0	0	0	0	
Kr-82 (g) ^k	8.1913E-07	0.0000E+00	2.5197E-04	2.9777E-04	2.5897E-04	1.7157E-04	0.
+/- ^j	0.0000E+00	NA	2.1790E-05	3.1786E-05	3.1130E-05	2.0151E-05	NA
Segment Total							
+/- ⁿ							
Kr-83 (mol%) ^d	14.9	14.9	14.9	14.9	14.9	14.9	
+/- ^d	0.1	0.1	0.1	0.1	0.1	0.1	
Kr-83 (g) ^k	6.1771E-05	0.0000E+00	1.9001E-02	2.2455E-02	1.9529E-02	1.2938E-02	0.
+/- ^j	4.1457E-07	NA	1.6481E-03	2.4017E-03	2.3511E-03	1.5221E-03	NA
Segment Total							
+/- ⁿ							
Kr-84 (mol%) ^d	30.8	30.8	30.8	30.8	30.8	30.8	
+/- ^d	0.1	0.1	0.1	0.1	0.1	0.1	
Kr-84 (g) ^k	1.2922E-04	0.0000E+00	3.9750E-02	4.6975E-02	4.0855E-02	2.7066E-02	0.
+/- ^j	4.1956E-07	NA	3.4399E-03	5.0167E-03	4.9127E-03	3.1802E-03	NA
Segment Total							
+/- ⁿ							

B-70

Rod "M" 0504042 (SI-1, 5L29)

	M-00	M-01	M-02	M-03	M-04	M-05	M-06
seg length (in) ^a	10.078	10.088	21.438	21.24	21.24	21.308	
total length (in)							
Kr-85 (mol%) ^d	5.7	5.7	5.7	5.7	5.7	5.7	
+/- ^d	0.1	0.1	0.1	0.1	0.1	0.1	
Kr-85 (g) ^k	2.4200E-05	0.0000E+00	7.4441E-03	8.7972E-03	7.6510E-03	5.0687E-03	0.0
+/- ^j	4.2456E-07	NA	6.5686E-04	9.5166E-04	9.2942E-04	6.0194E-04	NA
Segment Total							
+/- ⁿ							
Kr-86 (mol%) ^d	48.5	48.5	48.5	48.5	48.5	48.5	
+/- ^d	0.1	0.1	0.1	0.1	0.1	0.1	
Kr-86 (g) ^k	2.0833E-04	0.0000E+00	6.4085E-02	7.5733E-02	6.5866E-02	4.3636E-02	0.0
+/- ^j	4.2955E-07	NA	5.5434E-03	8.0857E-03	7.9184E-03	5.1259E-03	NA
Segment Total							
+/- ⁿ							
Rod Total							
+/- ⁿ							
shear gas (g) ^e	0	0.0001	0.0031	0.0071	0.006	0.002	
+/- ^e	0	0.0003	0.0006	0.0014	0.0012	0.0004	
moles Kr (diss+pl) ^d	0.000005	0	0.001533	0.001806	0.001571	0.001044	
+/- ^d	0	0	0.000133	0.000194	0.00019	0.000123	
Kr+Xe diss&pl (g) ^d	0.0029	0.0112	0.9443	1.1056	0.9644	0.641	
+/- ^d	0.0001	0.0112	0.0549	0.0881	0.066	0.0425	
moles kr (tot) ^o	5.0000E-06	0.0000E+00	1.5380E-03	1.8176E-03	1.5808E-03	1.0473E-03	0.0
+/- ^p	0.0000E+00	0.0000E+00	1.3300E-04	1.9402E-04	1.9001E-04	1.2300E-04	0.0
Xe-128 (mol%) ^d	0.1	0.1	0.1	0.1	0.1	0.1	
+/- ^d	0	0	0	0	0	0	
Xe-128 (g) ^k	2.4302E-06	1.0711E-05	7.7828E-04	9.1317E-04	7.9665E-04	5.2797E-04	8.5
+/- ^j	1.2790E-07	1.0621E-05	5.1164E-05	8.2509E-05	6.0892E-05	3.9268E-05	8.5
SegmentTotal							
+/- ⁿ							

B-71

Rod "M" 0504042 (SI-1, 5L29)

	M-00	M-01	M-02	M-03	M-04	M-05	M-06
seg length (in) ^a	10.078	10.088	21.438	21.24	21.24	21.308	
total length (in)							
Xe-130 (mol%) ^d	0.1	0.1	0.1	0.1	0.1	0.1	
+/- ^d	0	0	0	0	0	0	
Xe-130 (g) ^k	2.4682E-06	1.0878E-05	7.9045E-04	9.2745E-04	8.0911E-04	5.3622E-04	
+/- ^j	1.2990E-07	1.0787E-05	5.1964E-05	8.3799E-05	6.1844E-05	3.9882E-05	
SegmentTotal							
+/- ⁿ							
Xe-131 (mol%) ^d	10.7	10.7	10.7	10.7	10.7	10.7	
+/- ^d	0.1	0.1	0.1	0.1	0.1	0.1	
Xe-131 (g) ^k	2.6613E-04	1.1729E-03	8.5230E-02	1.0000E-01	8.7242E-02	5.7818E-02	
+/- ^j	1.4226E-05	1.1631E-03	5.6594E-03	9.0838E-03	6.7180E-03	4.3341E-03	
SegmentTotal							
+/- ⁿ							
Xe-132 (mol%) ^d	23.6	23.6	23.6	23.6	23.6	23.6	
+/- ^d	0.1	0.1	0.1	0.1	0.1	0.1	
Xe-132 (g) ^k	5.9146E-04	2.6068E-03	1.8942E-01	2.2225E-01	1.9389E-01	1.2850E-01	
+/- ^j	3.1230E-05	2.5849E-03	1.2478E-02	2.0103E-02	1.4843E-02	9.5726E-03	
SegmentTotal							
+/- ⁿ							
Xe-134 (mol%) ^d	25.7	25.7	25.7	25.7	25.7	25.7	
+/- ^d	0.1	0.1	0.1	0.1	0.1	0.1	
Xe-134 (g) ^k	6.5386E-04	2.8818E-03	2.0940E-01	2.4570E-01	2.1435E-01	1.4205E-01	
+/- ^j	3.4508E-05	2.8576E-03	1.3790E-02	2.2220E-02	1.6405E-02	1.0580E-02	
SegmentTotal							
+/- ⁿ							

B-72

Rod "M" 0504042 (SI-1, 5L29)

	M-00	M-01	M-02	M-03	M-04	M-05	M-06
seg length (in) ^a	10.078	10.088	21.438	21.24	21.24	21.308	
total length (in)							
Xe-136 (mol%) ^d	39.8	39.8	39.8	39.8	39.8	39.8	
+/- ^d	0.1	39.8	39.8	39.8	39.8	39.8	
Xe-136 (g) ^k	1.0277E-03	4.5296E-03	3.2914E-01	3.8619E-01	3.3691E-01	2.2328E-01	3.624
+/- ^j	5.4153E-05	6.3790E-03	3.2985E-01	3.8776E-01	3.3789E-01	2.2390E-01	5.125
SegmentTotal							
+/- ⁿ							
Rod total							
+/- ⁿ							
shear gas (g) ^e	0	0.0001	0.0031	0.0071	0.006	0.002	
+/- ^e	0	0.0003	0.0006	0.0014	0.0012	0.0004	0
moles Xe (diss+pl) ^d	0.000019	0.000083	0.006065	0.007094	0.00619	0.004115	0.00
+/- ^d	0.000001	0.000083	0.0004	0.000645	0.000476	0.000307	0.00
Kr+Xe diss&pl (g) ^d	0.0029	0.0112	0.9443	1.1056	0.9644	0.641	
+/- ^d	0.0001	0.0112	0.0549	0.0881	0.066	0.0425	
moles Xe (tot) ^o	1.9000E-05	8.3741E-05	6.0849E-03	7.1396E-03	6.2285E-03	4.1278E-03	6.700
+/- ^p	1.0000E-06	8.3036E-05	4.0002E-04	6.4509E-04	4.7608E-04	3.0701E-04	6.700
Values corrected to 1/1/84 (page 181, Final Report for the LWBR Proof of Breeding Analytical Support Project)							
Cs-137 (atoms) ^f	ND	1.0800E+19	7.9880E+20	1.0550E+21	1.0030E+21	5.6080E+20	3.9940
+/- ^f	NA	5.6480E+16	3.5060E+18	5.3850E+18	5.1180E+18	2.9430E+18	2.2400
Cs-137 (g) ^m	NA	2.4550E-03	1.8158E-01	2.3982E-01	2.2800E-01	1.2748E-01	9.078
+/- ^m	NA	1.2839E-05	7.9696E-04	1.2241E-03	1.1634E-03	6.6899E-04	5.091
Total							
+/- ⁿ							
Ce-144 (atoms) ^g	ND	3.3580E+17	2.0240E+19	3.9190E+19	5.2520E+19	4.5750E+19	6.2190
+/- ^g	NA	2.6120E+15	1.3860E+17	2.9100E+17	4.0380E+17	3.5190E+17	4.8400
Ce-144 (g) ^m	NA	8.0239E-05	4.8363E-03	9.3644E-03	1.2550E-02	1.0932E-02	1.486
+/- ^m	NA	6.2413E-07	3.3118E-05	6.9534E-05	9.6487E-05	8.4086E-05	1.156
Total							
+/- ⁿ							

Rod "M" 0504042 (SI-1, 5L29)

	M-00	M-01	M-02	M-03	M-04	M-05	M-06
seg length (in) ^a	10.078	10.088	21.438	21.24	21.24	21.308	
total length (in)							
Zr-95 (atoms) ^h	ND	ND	ND	2.6190E+17	4.6540E+17	3.9990E+17	
+/- ^h	NA	NA	NA	2.9000E+16	5.5950E+16	2.8960E+16	
Zr-95 (g) ^m	NA	NA	NA	4.1270E-05	7.3338E-05	6.3017E-05	
+/- ^m	NA	NA	NA	4.5698E-06	8.8167E-06	4.5635E-06	
Total							
+/- ⁿ							

Footnotes

- a. ANL Destructive Chemical Assay of 33-Rod LWBR EOL Sample - Rod M, 0504042, page 4
- b. ANL Destructive Chemical Assay of 33-Rod LWBR EOL Sample - Rod M, 0504042, page 7
- c. ANL Destructive Chemical Assay of 33-Rod LWBR EOL Sample - Rod M, 0504042, page 8
- d. ANL Destructive Chemical Assay of 33-Rod LWBR EOL Sample - Rod M, 0504042, page 11
- e. ANL Destructive Chemical Assay of 33-Rod LWBR EOL Sample - Rod M, 0504042, page 12
- f. ANL Destructive Chemical Assay of 33-Rod LWBR EOL Sample - Rod M, 0504042, page 13
- g. ANL Destructive Chemical Assay of 33-Rod LWBR EOL Sample - Rod M, 0504042, page 14
- h. ANL Destructive Chemical Assay of 33-Rod LWBR EOL Sample - Rod M, 0504042, page 15
- i. (abundance of the specified isotope)(total weight of uranium) / 100
- j. Error Propagation = $((sd_x/x)^2 + (sd_y/y)^2)^{1/2} (xy)$, where sd is the +/- in the table
- k. (mole%)(number moles gas recovered)(molec wt) / 100
- m. (number of atoms per segment)(atomic weight) / 6.0228E+23
- n. Error Propagation = $(\sum(sd_i^2))^{1/2}$, where sd is the +/- in the table
- o. ((shear gas / Xe + Kr (diss&pl)))(moles Xe or Kr (diss + pl)) + moles Xe or Kr (diss + pl)
- p. Error Propagation = $((((sd_x/x)^2 + (sd_y/y)^2 + (sd_z/z)^2)^{1/2} (xy/z))^2 + (sd_y)^2)^{1/2}$, where sd is the +/- in the table

Rod "N" 0507057 (SI-1, 5C10)

	N-00	N-01	N-02	N-03	N-04	N-05	N-06
seg length (in) ^a	10.228	10.08	21.368	21.171	21.169	21.243	
total length (in)							
U-232 wt% ^b	0	0.04	0.055	0.1181	0.1228	0.0413	0
+/- ^b	0	0.0012	0.0017	0.0037	0.0038	0.0013	0
U-232 g ^l	0.0000E+00	1.3013E-04	3.9700E-03	7.7510E-03	7.9892E-03	3.0539E-03	4.972E-03
+/- ^j	NA	3.9041E-06	1.2271E-04	2.4284E-04	2.4723E-04	9.6130E-05	1.524E-04
Segment Total							
+/- ⁿ							
U-233 wt% ^b	100	97.3294	90.9788	86.2675	85.9847	92.2898	98.2
+/- ^b	0	0.0129	0.0049	0.0059	0.005	0.0062	0
U-233 g ^l	4.0000E-05	3.1664E-01	6.5670E+00	5.6618E+00	5.5940E+00	6.8243E+00	1.871E+01
+/- ^j	1.0000E-05	9.7131E-05	1.4892E-03	1.3507E-03	1.3052E-03	1.7055E-03	1.064E-03
Segment Total							
+/- ⁿ							
U-234 wt% ^b	0	2.488	7.5417	11.1477	11.3575	6.4854	1
+/- ^b	0	0.0009	0.0009	0.0012	0.0011	0.0009	0
U-234 g ^l	0.0000E+00	8.0942E-03	5.4437E-01	7.3163E-01	7.3890E-01	4.7956E-01	3.177E-01
+/- ^j	NA	3.6861E-06	1.3638E-04	1.8483E-04	1.8165E-04	1.3325E-04	2.391E-04
Segment Total							
+/- ⁿ							
U-235 wt% ^b	0	0.1296	1.06	2.0017	2.0629	0.8391	0
+/- ^b	0	0.0094	0.0036	0.004	0.0031	0.0046	0
U-235 g ^l	0.0000E+00	4.2163E-04	7.6513E-02	1.3137E-01	1.3421E-01	6.2046E-02	1.044E-01
+/- ^j	NA	3.0581E-05	2.6040E-04	2.6423E-04	2.0395E-04	3.4047E-04	2.953E-04
Segment Total							
+/- ⁿ							
U-236 wt% ^b	0	0.0026	0.0663	0.1621	0.1711	0.0495	0
+/- ^b	0	0.0001	0.0001	0.0001	0.0001	0.0001	0
U-236 g ^l	0.0000E+00	8.4586E-06	4.7856E-03	1.0639E-02	1.1131E-02	3.6602E-03	1.714E-03
+/- ^j	NA	3.2534E-07	7.2947E-06	6.9990E-06	6.9751E-06	7.4467E-06	1.905E-06
Segment Total							
+/- ⁿ							

B-75

Rod "N" 0507057 (SI-1, 5C10)

	N-00	N-01	N-02	N-03	N-04	N-05	N-06
seg length (in) ^a	10.228	10.08	21.368	21.171	21.169	21.243	
total length (in)							
U-238 wt% ^b	0	0.0104	0.2982	0.3029	0.301	0.2949	
+/- ^b	0	0.0093	0.0035	0.0039	0.0029	0.0045	
U-238 g ⁱ	0.0000E+00	3.3834E-05	2.1525E-02	1.9880E-02	1.9583E-02	2.1806E-02	4.0
+/- ^j	NA	3.0256E-05	2.5268E-04	2.5600E-04	1.8872E-04	3.3279E-04	2.9
Segment Total							
+/- ⁿ							
tot U ^c	0.00009	0.32533	7.21817	6.56307	6.50583	7.39439	
+/- ^c	0.00001	0.00009	0.00159	0.0015	0.00147	0.00178	
Kr-82 (mol%) ^d	0.2	0.2	0.2	0.2	0.2	0.2	
+/- ^d	0	0	0	0	0	0	
Kr-82 (g) ^k	4.9148E-07	0.0000E+00	2.0637E-04	2.1579E-04	2.7483E-04	1.6324E-04	1.1
+/- ^j	0.0000E+00	NA	2.4247E-05	2.9818E-05	3.0474E-05	1.9168E-05	8.4
Segment Total							
+/- ⁿ							
Kr-83 (mol%) ^d	15.7	15.7	15.7	15.7	15.7	15.7	
+/- ^d	0.2	0.2	0.2	0.2	0.2	0.2	
Kr-83 (g) ^k	3.9053E-05	0.0000E+00	1.6398E-02	1.7147E-02	2.1838E-02	1.2971E-02	8.8
+/- ^j	4.9748E-07	NA	1.9379E-03	2.3794E-03	2.4373E-03	1.5320E-03	6.7
Segment Total							
+/- ⁿ							
Kr-84 (mol%) ^d	29.9	29.9	29.9	29.9	29.9	29.9	
+/- ^d	0.1	0.1	0.1	0.1	0.1	0.1	
Kr-84 (g) ^k	7.5269E-05	0.0000E+00	3.1605E-02	3.3048E-02	4.2090E-02	2.4999E-02	1.7
+/- ^j	2.5173E-07	NA	3.7148E-03	4.5679E-03	4.6691E-03	2.9367E-03	1.2
Segment Total							
+/- ⁿ							

B-76

Rod "N" 0507057 (SI-1, 5C10)

	N-00	N-01	N-02	N-03	N-04	N-05	N-06
seg length (in) ^a	10.228	10.08	21.368	21.171	21.169	21.243	
total length (in)							
Kr-85 (mol%) ^d	5.7	5.7	5.7	5.7	5.7	5.7	5.7
+/- ^d	0.1	0.1	0.1	0.1	0.1	0.1	0.1
Kr-85 (g) ^k	1.4520E-05	0.0000E+00	6.0968E-03	6.3753E-03	8.1196E-03	4.8225E-03	3.2
+/- ^j	2.5474E-07	NA	7.2427E-04	8.8801E-04	9.1150E-04	5.7258E-04	2.5
Segment Total							
+/- ⁿ							
Kr-86 (mol%) ^d	48.5	48.5	48.5	48.5	48.5	48.5	48.5
+/- ^d	0.1	0.1	0.1	0.1	0.1	0.1	0.1
Kr-86 (g) ^k	1.2500E-04	0.0000E+00	5.2486E-02	5.4883E-02	6.9900E-02	4.1516E-02	2.8
+/- ^j	2.5773E-07	NA	6.1677E-03	7.5846E-03	7.7518E-03	4.8759E-03	2.1
Segment Total							
+/- ⁿ							
Rod Total							
+/- ⁿ							
shear gas (g) ^e	0	0	0.0016	0.0041	0.005	0.002	
+/- ^e	0	0.0003	0.0003	0.0008	0.001	0.0004	
moles Kr (diss+pl) ^d	0.000003	0	0.001257	0.00131	0.001669	0.000993	
+/- ^d	0	0	0.000148	0.000182	0.000186	0.000117	
Kr+Xe diss&pl (g) ^d	0.0016	0.0164	0.7518	0.746	0.9713	0.5857	
+/- ^d	0.0001	0.0164	0.0417	0.0989	0.0845	0.0481	
moles kr (tot) ^o	3.0000E-06	0.0000E+00	1.2597E-03	1.3172E-03	1.6776E-03	9.9639E-04	6.7
+/- ^p	0.0000E+00	0.0000E+00	1.4800E-04	1.8201E-04	1.8601E-04	1.1700E-04	5.1
Xe-128 (mol%) ^d	0.1	0.1	0.1	0.1	0.1	0.1	0.1
+/- ^d	0	0	0	0	0	0	0
Xe-128 (g) ^k	1.2790E-06	1.5604E-05	6.1627E-04	6.0844E-04	7.9490E-04	4.7961E-04	3.2
+/- ^j	0.0000E+00	1.5604E-05	3.7860E-05	9.3118E-05	7.9050E-05	4.4768E-05	2.4
SegmentTotal							
+/- ⁿ							

B-77

Rod "N" 0507057 (SI-1, 5C10)

	N-00	N-01	N-02	N-03	N-04	N-05	N-06
seg length (in) ^a	10.228	10.08	21.368	21.171	21.169	21.243	
total length (in)							
Xe-130 (mol%) ^d	0.1	0.1	0.1	0.1	0.1	0.1	
+/- ^d	0	0	0	0	0	0	
Xe-130 (g) ^k	1.2990E-06	1.5848E-05	6.2591E-04	6.1795E-04	8.0733E-04	4.8711E-04	
+/- ^j	0.0000E+00	1.5848E-05	3.8452E-05	9.4575E-05	8.0286E-05	4.5468E-05	
SegmentTotal							
+/- ⁿ							
Xe-131 (mol%) ^d	11.8	11.8	11.8	11.8	11.8	11.8	
+/- ^d	0.1	0.1	0.1	0.1	0.1	0.1	
Xe-131 (g) ^k	1.5447E-04	1.8845E-03	7.4426E-02	7.3480E-02	9.5999E-02	5.7922E-02	
+/- ^j	1.3091E-06	1.8846E-03	4.6157E-03	1.1263E-02	9.5815E-03	5.4288E-03	
SegmentTotal							
+/- ⁿ							
Xe-132 (mol%) ^d	24	24	24	24	24	24	
+/- ^d	0.1	0.1	0.1	0.1	0.1	0.1	
Xe-132 (g) ^k	3.1657E-04	3.8622E-03	1.5253E-01	1.5059E-01	1.9674E-01	1.1871E-01	
+/- ^j	1.3190E-06	3.8622E-03	9.3922E-03	2.3056E-02	1.9583E-02	1.1091E-02	
SegmentTotal							
+/- ⁿ							
Xe-134 (mol%) ^d	26.6	26.6	26.6	26.6	26.6	26.6	
+/- ^d	0.1	0.1	0.1	0.1	0.1	0.1	
Xe-134 (g) ^k	3.5619E-04	4.3455E-03	1.7162E-01	1.6944E-01	2.2136E-01	1.3356E-01	
+/- ^j	1.3391E-06	4.3455E-03	1.0563E-02	2.5940E-02	2.2030E-02	1.2477E-02	
SegmentTotal							
+/- ⁿ							

B-78

Rod "N" 0507057 (SI-1, 5C10)

	N-00	N-01	N-02	N-03	N-04	N-05	N-06
seg length (in) ^a	10.228	10.08	21.368	21.171	21.169	21.243	9
total length (in)							
Xe-136 (mol%) ^d	37.5	37.5	37.5	37.5	37.5	37.5	
+/- ^d	0.2	0.2	0.2	0.2	0.2	0.2	
Xe-136 (g) ^k	5.0965E-04	6.2178E-03	2.4556E-01	2.4244E-01	3.1674E-01	1.9111E-01	1.3007
+/- ^j	2.7181E-06	6.2178E-03	1.5143E-02	3.7127E-02	3.1544E-02	1.7868E-02	9.8892
SegmentTotal							
+/- ⁿ							
Rod total							
+/- ⁿ							
shear gas (g) ^e	0	0	0.0016	0.0041	0.005	0.002	0.
+/- ^e	0	0.0003	0.0003	0.0008	0.001	0.0004	0.
moles Xe (diss+pl) ^d	0.00001	0.000122	0.004808	0.004731	0.006183	0.003737	
+/- ^d	0	0.000122	0.000296	0.000728	0.000618	0.00035	
Kr+Xe diss&pl (g) ^d	0.0016	0.0164	0.7518	0.746	0.9713	0.5857	
+/- ^d	0.0001	0.0164	0.0417	0.0989	0.0845	0.0481	
moles Xe (tot) ^o	1.0000E-05	1.2200E-04	4.8182E-03	4.7570E-03	6.2148E-03	3.7498E-03	2.5522
+/- ^p	0.0000E+00	1.2200E-04	2.9601E-04	7.2804E-04	6.1805E-04	3.5001E-04	1.9403
Values corrected to 1/1/84 (page 181, Final Report for the LWBR Proof of Breeding Analytical Support Project)							
Cs-137 (atoms) ^f	NA	9.3490E+18	5.9200E+20	8.9150E+20	9.1270E+20	5.1590E+20	3.6830
+/- ^f	NA	2.7340E+16	1.6330E+18	2.4660E+18	2.6410E+18	1.5560E+18	1.3090
Cs-137 (g) ^m	NA	2.1252E-03	1.3457E-01	2.0265E-01	2.0747E-01	1.1727E-01	8.3720
+/- ^m	NA	6.2148E-06	3.7120E-04	5.6056E-04	6.0034E-04	3.5370E-04	2.9755
Total							
+/- ⁿ							
Ce-144 (atoms) ^g	NA	2.9230E+17	1.6300E+19	3.5170E+19	4.8440E+19	4.2250E+19	5.7740
+/- ^g	NA	2.0030E+15	1.1050E+17	2.3870E+17	3.3830E+17	2.8650E+17	3.8640
Ce-144 (g) ^m	NA	6.9844E-05	3.8948E-03	8.4038E-03	1.1575E-02	1.0096E-02	1.3797
+/- ^m	NA	4.7861E-07	2.6404E-05	5.7037E-05	8.0836E-05	6.8459E-05	9.2329
Total							
+/- ⁿ							

Rod "N" 0507057 (SI-1, 5C10)

	N-00	N-01	N-02	N-03	N-04	N-05	N
seg length (in) ^a	10.228	10.08	21.368	21.171	21.169	21.243	
total length (in)							
Zr-95 (atoms) ^h	NA	ND	ND	2.0490E+17	3.9550E+17	4.2690E+17	
+/- ^h	NA	NA	NA	3.6920E+16	5.3040E+16	3.2790E+16	
Zr-95 (g) ^m	NA	NA	NA	3.2288E-05	6.2323E-05	6.7271E-05	
+/- ^m	NA	NA	NA	5.8179E-06	8.3581E-06	5.1671E-06	
Total							
+/- ⁿ							

Footnotes

- a. ANL Destructive Chemical Assay of 33-Rod LWBR EOL Sample - Rod N, 0507057, page 4
- b. ANL Destructive Chemical Assay of 33-Rod LWBR EOL Sample - Rod N, 0507057, page 7
- c. ANL Destructive Chemical Assay of 33-Rod LWBR EOL Sample - Rod N, 0507057, page 8
- d. ANL Destructive Chemical Assay of 33-Rod LWBR EOL Sample - Rod N, 0507057, page 11
- e. ANL Destructive Chemical Assay of 33-Rod LWBR EOL Sample - Rod N, 0507057, page 12
- f. ANL Destructive Chemical Assay of 33-Rod LWBR EOL Sample - Rod N, 0507057, page 13
- g. ANL Destructive Chemical Assay of 33-Rod LWBR EOL Sample - Rod N, 0507057, page 14
- h. ANL Destructive Chemical Assay of 33-Rod LWBR EOL Sample - Rod N, 0507057, page 15
- i. (abundance of the specified isotope)(total weight of uranium) / 100
- j. Error Propagation = $((sd_x/x)^2 + (sd_y/y)^2)^{1/2}(xy)$, where sd is the +/- in the table
- k. (mole%)(number moles gas recovered)(molec wt) / 100
- m. (number of atoms per segment)(atomic weight) / 6.0228E+23
- n. Error Propagation = $(\text{SUM}(sd_i^2))^{1/2}$, where sd is the +/- in the table
- o. ((shear gas / Xe + Kr (diss&pl))(moles Xe or Kr (diss + pl)) + moles Xe or Kr (diss + pl)
- p. Error Propagation = $(((((sd_x/x)^2 + (sd_y/y)^2 + (sd_z/z)^2)^{1/2} (xy/z))^2 + (sd_y)^2)^{1/2}$, where sd is the +/- in the table

Rod "O" 0201562 (SI-1, 2P39)

	O-00	O-01	O-02	O-03	O-04	O-05	O-06
seg length (in) ^a	11.527	17.912	17.606	17.409	21.29	21.163	
total length (in)							
U-232 wt% ^b	0	0.0926	0.2163	0.2783	0.1645	0.056	0
+/- ^b	0	0.0029	0.0067	0.0086	0.0051	0.0017	0
U-232 g ⁱ	0.0000E+00	8.7009E-04	4.1808E-03	5.9158E-03	7.9416E-03	3.1464E-03	5.123
+/- ^j	NA	2.7250E-05	1.2951E-04	1.8298E-04	2.4622E-04	9.5519E-05	1.607
Segment Total							
+/- ⁿ							
U-233 wt% ^b	100	94.5383	88.1054	86.0389	80.8887	89.8139	98
+/- ^b	0	0.0063	0.0096	0.009	0.0068	0.007	0
U-233 g ⁱ	4.0000E-05	8.8830E-01	1.7030E+00	1.8289E+00	3.9051E+00	5.0462E+00	1.969
+/- ^j	1.0000E-05	2.2535E-04	5.4366E-04	2.4253E-03	1.0323E-03	1.4034E-03	8.783
Segment Total							
+/- ⁿ							
U-234 wt% ^b	0	4.8371	9.8257	11.3124	15.1822	8.48	1
+/- ^b	0	0.001	0.0015	0.0015	0.0017	0.0012	0
U-234 g ⁱ	0.0000E+00	4.5450E-02	1.8992E-01	2.4047E-01	7.3296E-01	4.7645E-01	3.752
+/- ^j	NA	1.4562E-05	6.3940E-05	3.1947E-04	2.0120E-04	1.4396E-04	2.836
Segment Total							
+/- ⁿ							
U-235 wt% ^b	0	0.5023	1.7012	2.148	3.0086	1.1655	0
+/- ^b	0	0.0042	0.006	0.004	0.0045	0.0053	0
U-235 g ⁱ	0.0000E+00	4.7197E-03	3.2882E-02	4.5660E-02	1.4525E-01	6.5484E-02	1.336
+/- ^j	NA	3.9481E-05	1.1639E-04	1.0427E-04	2.2028E-04	2.9829E-04	2.853
Segment Total							
+/- ⁿ							
U-236 wt% ^b	0	0.0237	0.1469	0.2158	0.3271	0.073	0
+/- ^b	0	0.0001	0.0001	0.0001	0.0001	0.0001	0
U-236 g ⁱ	0.0000E+00	2.2269E-04	2.8394E-03	4.5872E-03	1.5792E-02	4.1015E-03	2.210
+/- ^j	NA	9.4120E-07	2.1123E-06	6.4258E-06	6.2428E-06	5.7242E-06	2.009
Segment Total							
+/- ⁿ							

Rod "O" 0201562 (SI-1, 2P39)

	O-00	O-01	O-02	O-03	O-04	O-05	O-06
seg length (in) ^a	11.527	17.912	17.606	17.409	21.29	21.163	
total length (in)							
U-238 wt% ^b	0	0.0059	0.0045	0.0065	0.4288	0.4117	
+/- ^b	0	0.0042	0.006	0.004	0.0046	0.0053	
U-238 g ⁱ	0.0000E+00	5.5438E-05	8.6980E-05	1.3817E-04	2.0701E-02	2.3131E-02	4.1
+/- ^j	NA	3.9464E-05	1.1597E-04	8.5028E-05	2.2214E-04	2.9785E-04	2.8
Segment Total							
+/- ⁿ							
tot U ^c	0.00015	0.93962	1.93288	2.12569	4.82775	5.61852	
+/- ^c	0.00001	0.00023	0.00058	0.00281	0.00121	0.0015	
Kr-82 (mol%) ^d	0.2	0.2	0.2	0.2	0.2	0.2	
+/- ^d	0	0	0	0	0	0	
Kr-82 (g) ^k	3.2765E-07	1.7229E-05	5.8050E-05	7.9274E-05	3.2903E-04	1.6849E-04	0.0
+/- ^j	0.0000E+00	2.1313E-06	7.0451E-06	1.9660E-05	4.8008E-05	1.9660E-05	NA
Segment Total							
+/- ⁿ							
Kr-83 (mol%) ^d	15.2	15.2	15.2	15.2	15.2	15.2	
+/- ^d	0.1	0.1	0.1	0.1	0.1	0.1	
Kr-83 (g) ^k	2.5206E-05	1.3254E-03	4.4657E-03	6.0984E-03	2.5312E-02	1.2962E-02	0.0
+/- ^j	1.6583E-07	1.6419E-04	5.4277E-04	1.5129E-03	3.6969E-03	1.5148E-03	NA
Segment Total							
+/- ⁿ							
Kr-84 (mol%) ^d	30.4	30.4	30.4	30.4	30.4	30.4	
+/- ^d	0.1	0.1	0.1	0.1	0.1	0.1	
Kr-84 (g) ^k	5.1018E-05	2.6827E-03	9.0388E-03	1.2344E-02	5.1233E-02	2.6235E-02	0.0
+/- ^j	1.6782E-07	3.3198E-04	1.0974E-03	3.0614E-03	7.4771E-03	3.0624E-03	NA
Segment Total							
+/- ⁿ							

B-82

Rod "O" 0201562 (SI-1, 2P39)

	O-00	O-01	O-02	O-03	O-04	O-05	O-06
seg length (in) ^a	11.527	17.912	17.606	17.409	21.29	21.163	
total length (in)							
Kr-85 (mol%) ^d	5.7	5.7	5.7	5.7	5.7	5.7	
+/- ^d	0.1	0.1	0.1	0.1	0.1	0.1	
Kr-85 (g) ^k	9.6800E-06	5.0900E-04	1.7150E-03	2.3420E-03	9.7207E-03	4.9778E-03	0.00
+/- ^j	1.6982E-07	6.3596E-05	2.1030E-04	5.8226E-04	1.4285E-03	5.8735E-04	NA
Segment Total							
+/- ⁿ							
Kr-86 (mol%) ^d	48.7	48.7	48.7	48.7	48.7	48.7	
+/- ^d	0.2	0.2	0.2	0.2	0.2	0.2	
Kr-86 (g) ^k	8.3677E-05	4.4000E-03	1.4825E-02	2.0245E-02	8.4029E-02	4.3029E-02	0.00
+/- ^j	3.4364E-07	5.4460E-04	1.8002E-03	5.0214E-03	1.2265E-02	5.0239E-03	NA
Segment Total							
+/- ⁿ							
Rod Total							
+/- ⁿ							
shear gas (g) ^e	0	0.0001	0.0008	0.0013	0.0111	0.0026	
+/- ^e	0	0.0003	0.0003	0.0003	0.0022	0.0005	
moles Kr (diss+pl) ^d	0.000002	0.000105	0.000353	0.000482	0.001991	0.001024	
+/- ^d	0	0.000013	0.000043	0.00012	0.000293	0.00012	
Kr+Xe diss&pl (g) ^d	0.0013	0.0635	0.2116	0.3319	1.2697	0.5963	
+/- ^d	0.0001	0.0054	0.0198	0.0417	0.1592	0.0496	
moles kr (tot) ^o	2.0000E-06	1.0517E-04	3.5433E-04	4.8389E-04	2.0084E-03	1.0285E-03	0.00
+/- ^p	0.0000E+00	1.3009E-05	4.3003E-05	1.2000E-04	2.9304E-04	1.2000E-04	0.00
Xe-128 (mol%) ^d	0.1	0.1	0.1	0.1	0.1	0.1	
+/- ^d	0	0	0	0	0	0	
Xe-128 (g) ^k	1.0232E-06	5.2139E-05	1.7371E-04	3.0637E-04	1.0577E-03	4.8738E-04	1.4
+/- ^j	0.0000E+00	4.9943E-06	1.8548E-05	3.8501E-05	1.4980E-04	4.6176E-05	1.3
SegmentTotal							
+/- ⁿ							

Rod "O" 0201562 (SI-1, 2P39)

	O-00	O-01	O-02	O-03	O-04	O-05	O-06
seg length (in) ^a	11.527	17.912	17.606	17.409	21.29	21.163	
total length (in)							
Xe-130 (mol%) ^d	0.2	0.2	0.2	0.2	0.2	0.2	
+/- ^d	0	0	0	0	0	0	
Xe-130 (g) ^k	2.0785E-06	1.0591E-04	3.5285E-04	6.2233E-04	2.1485E-03	9.9001E-04	
+/- ^j	0.0000E+00	1.0145E-05	3.7676E-05	7.8205E-05	3.0428E-04	9.3796E-05	
SegmentTotal							
+/- ⁿ							
Xe-131 (mol%) ^d	10.9	10.9	10.9	10.9	10.9	10.9	
+/- ^d	0.1	0.1	0.1	0.1	0.1	0.1	
Xe-131 (g) ^k	1.1415E-04	5.8165E-03	1.9378E-02	3.4178E-02	1.1800E-01	5.4371E-02	
+/- ^j	1.0472E-06	5.5970E-04	2.0768E-03	4.3065E-03	1.6746E-02	5.1754E-03	
SegmentTotal							
+/- ⁿ							
Xe-132 (mol%) ^d	22.9	22.9	22.9	22.9	22.9	22.9	
+/- ^d	0.1	0.1	0.1	0.1	0.1	0.1	
Xe-132 (g) ^k	2.4165E-04	1.2313E-02	4.1023E-02	7.2354E-02	2.4979E-01	1.1510E-01	
+/- ^j	1.0552E-06	1.1807E-03	4.3840E-03	9.0979E-03	3.5393E-02	1.0917E-02	
SegmentTotal							
+/- ⁿ							
Xe-134 (mol%) ^d	25	25	25	25	25	25	
+/- ^d	0.1	0.1	0.1	0.1	0.1	0.1	
Xe-134 (g) ^k	2.6781E-04	1.3646E-02	4.5465E-02	8.0187E-02	2.7684E-01	1.2756E-01	
+/- ^j	1.0712E-06	1.3083E-03	4.8580E-03	1.0082E-02	3.9222E-02	1.2096E-02	
SegmentTotal							
+/- ⁿ							

B-84

Rod "O" 0201562 (SI-1, 2P39)

	O-00	O-01	O-02	O-03	O-04	O-05	O-06
seg length (in) ^a	11.527	17.912	17.606	17.409	21.29	21.163	8
total length (in)							
Xe-136 (mol%) ^d	41	41	41	41	41	41	
+/- ^d	0.1	0.1	0.1	0.1	0.1	0.1	
Xe-136 (g) ^k	4.4578E-04	2.2715E-02	7.5677E-02	1.3347E-01	4.6080E-01	2.1233E-01	6.1569
+/- ^j	1.0873E-06	2.1765E-03	8.0826E-03	1.6776E-02	6.5269E-02	2.0123E-02	6.0761
SegmentTotal							
+/- ⁿ							
Rod total							
+/- ⁿ							
shear gas (g) ^e	0	0.0001	0.0008	0.0013	0.0111	0.0026	0.
+/- ^e	0	0.0003	0.0003	0.0003	0.0022	0.0005	0.
moles Xe (diss+pl) ^d	0.000008	0.000407	0.001353	0.002386	0.008198	0.003794	0.00
+/- ^d	0	0.000039	0.000145	0.000301	0.001171	0.000361	0.00
Kr+Xe diss&pl (g) ^d	0.0013	0.0635	0.2116	0.3319	1.2697	0.5963	0.
+/- ^d	0.0001	0.0054	0.0198	0.0417	0.1592	0.0496	0.
moles Xe (tot) ^o	8.0000E-06	4.0764E-04	1.3581E-03	2.3953E-03	8.2697E-03	3.8105E-03	1.1049
+/- ^p	0.0000E+00	3.9047E-05	1.4501E-04	3.0101E-04	1.1712E-03	3.6102E-04	1.0904
Values corrected to 1/1/84 (page 181, Final Report for the LWBR Proof of Breeding Analytical Support Project)							
Cs-137 (atoms) ^f	ND	5.2850E+19	2.3070E+20	3.0370E+20	1.0190E+21	5.8020E+20	4.3110E
+/- ^f	NA	1.4450E+17	6.3210E+17	9.7180E+17	2.7180E+18	1.7030E+18	1.4990E
Cs-137 (g) ^m	NA	1.2014E-02	5.2441E-02	6.9035E-02	2.3163E-01	1.3189E-01	9.7995E
+/- ^m	NA	3.2847E-05	1.4369E-04	2.2090E-04	6.1784E-04	3.8712E-04	3.4074E
Total							
+/- ⁿ							
Ce-144 (atoms) ^g	ND	1.8920E+18	1.0290E+19	1.8460E+19	5.2140E+19	4.6790E+19	6.7450E
+/- ^g	NA	1.3420E+16	7.4980E+16	1.3290E+17	3.6860E+17	3.2320E+17	4.7070E
Ce-144 (g) ^m	NA	4.5209E-04	2.4588E-03	4.4110E-03	1.2459E-02	1.1180E-02	1.6117E
+/- ^m	NA	3.2067E-06	1.7916E-05	3.1756E-05	8.8076E-05	7.7228E-05	1.1247E
Total							
+/- ⁿ							

Rod "O" 0201562 (SI-1, 2P39)

	O-00	O-01	O-02	O-03	O-04	O-05	O-06
seg length (in) ^a	11.527	17.912	17.606	17.409	21.29	21.163	21.163
total length (in)							
Zr-95 (atoms) ^h	ND	ND	6.1270E+16	1.4080E+17	4.6280E+17	4.3680E+17	4.3680E+17
+/- ^h	NA	NA	1.4150E+16	2.2960E+16	9.4580E+16	3.6910E+16	3.6910E+16
Zr-95 (g) ^m	NA	NA	9.6550E-06	2.2187E-05	7.2928E-05	6.8831E-05	6.8831E-05
+/- ^m	NA	NA	2.2298E-06	3.6181E-06	1.4904E-05	5.8163E-06	5.8163E-06
Total							
+/- ⁿ							

Footnotes

- a. ANL Destructive Chemical Assay of 33-Rod LWBR EOL Sample - Rod O, 0201562, page 4
- b. ANL Destructive Chemical Assay of 33-Rod LWBR EOL Sample - Rod O, 0201562, page 7
- c. ANL Destructive Chemical Assay of 33-Rod LWBR EOL Sample - Rod O, 0201562, page 8
- d. ANL Destructive Chemical Assay of 33-Rod LWBR EOL Sample - Rod O, 0201562, page 11
- e. ANL Destructive Chemical Assay of 33-Rod LWBR EOL Sample - Rod O, 0201562, page 12
- f. ANL Destructive Chemical Assay of 33-Rod LWBR EOL Sample - Rod O, 0201562, page 13
- g. ANL Destructive Chemical Assay of 33-Rod LWBR EOL Sample - Rod O, 0201562, page 14
- h. ANL Destructive Chemical Assay of 33-Rod LWBR EOL Sample - Rod O, 0201562, page 15
- i. (abundance of the specified isotope)(total weight of uranium) / 100
- j. Error Propagation = $((sd_x/x)^2 + (sd_y/y)^2)^{1/2} (xy)$, where sd is the +/- in the table
- k. (mole%)(number moles gas recovered)(molec wt) / 100
- m. (number of atoms per segment)(atomic weight) / 6.0228E+23
- n. Error Propagation = $(\sum(sd_i^2))^{1/2}$, where sd is the +/- in the table
- o. $((\text{shear gas} / \text{Xe} + \text{Kr}(\text{diss\&pl}))) (\text{moles Xe or Kr}(\text{diss} + \text{pl})) + \text{moles Xe or Kr}(\text{diss} + \text{pl})$
- p. Error Propagation = $(((((sd_x/x)^2 + (sd_y/y)^2 + (sd_z/z)^2)^{1/2} (xy/z))^2 + (sd_y)^2)^{1/2}$, where sd is the +/- in the table

Rod "P" 0307602 (SI-1, 3N63)

	P-00	P-01	P-02	P-03	P-04	P-05	P-06
seg length (in) ^a	10.355	17.587	20.541	21.401	17.671	17.74	9
total length (in)							
U-232 wt% ^b	0	0.0935	0.2329	0.1619	0.1269	0.0399	0.0
+/- ^b	0	0.0029	0.0072	0.005	0.0039	0.0012	0.0
U-232 g ⁱ	0.0000E+00	8.2375E-04	5.0879E-03	7.9195E-03	5.6130E-03	2.0185E-03	4.3078E-03
+/- ^j	NA	2.5550E-05	1.5730E-04	2.4459E-04	1.7251E-04	6.0709E-05	1.3285E-04
Segment Total							
+/- ⁿ							
U-233 wt% ^b	100	95.0065	89.4504	80.6674	84.5715	91.6893	98.1
+/- ^b	0	0.007	0.0094	0.0073	0.0077	0.0071	0.0
U-233 g ⁱ	4.0000E-05	8.3703E-01	1.9541E+00	3.9459E+00	3.7407E+00	4.6385E+00	1.8634E+00
+/- ^j	1.0000E-05	1.6404E-04	5.1665E-04	9.3409E-04	9.0388E-04	1.1053E-03	7.0289E-04
Segment Total							
+/- ⁿ							
U-234 wt% ^b	0	4.4433	8.7916	15.2482	12.4319	6.9345	1.6
+/- ^b	0	0.0014	0.0016	0.002	0.0018	0.0015	0.0
U-234 g ⁱ	0.0000E+00	3.9146E-02	1.9206E-01	7.4588E-01	5.4988E-01	3.5081E-01	3.2160E-01
+/- ^j	NA	1.4236E-05	5.8249E-05	1.9024E-04	1.4658E-04	1.0958E-04	3.0227E-04
Segment Total							
+/- ⁿ							
U-235 wt% ^b	0	0.4294	1.4143	3.1671	2.2858	0.9205	0.0
+/- ^b	0	0.0046	0.0052	0.005	0.0055	0.0052	0.0
U-235 g ⁱ	0.0000E+00	3.7831E-03	3.0897E-02	1.5492E-01	1.0110E-01	4.6568E-02	1.1234E-01
+/- ^j	NA	4.0533E-05	1.1385E-04	2.4692E-04	2.4432E-04	2.6328E-04	2.7517E-04
Segment Total							
+/- ⁿ							
U-236 wt% ^b	0	0.0181	0.1051	0.3862	0.2344	0.0792	0.0
+/- ^b	0	0.0002	0.0002	0.0002	0.0002	0.0002	0.0
U-236 g ⁱ	0.0000E+00	1.5946E-04	2.2960E-03	1.8891E-02	1.0368E-02	4.0067E-03	2.2772E-02
+/- ^j	NA	1.7623E-06	4.4046E-06	1.0620E-05	9.1456E-06	1.0158E-05	3.7954E-05
Segment Total							
+/- ⁿ							

Rod "P" 0307602 (SI-1, 3N63)

	P-00	P-01	P-02	P-03	P-04	P-05	P-
seg length (in) ^a	10.355	17.587	20.541	21.401	17.671	17.74	
total length (in)							
U-238 wt% ^b	0	0.0092	0.0057	0.3691	0.3495	0.3366	
+/- ^b	0	0.0047	0.0053	0.0051	0.0056	0.0053	
U-238 g ^l	0.0000E+00	8.1054E-05	1.2452E-04	1.8055E-02	1.5459E-02	1.7028E-02	
+/- ^j	NA	4.1408E-05	1.1578E-04	2.4950E-04	2.4772E-04	2.6815E-04	
Segment Total							
+/- ⁿ							
tot U ^c	0.00029	0.88102	2.1846	4.89162	4.42316	5.05896	
+/- ^c	0.00001	0.00016	0.00053	0.00107	0.00099	0.00114	
Kr-82 (mol%) ^d	0.2	0.2	0.2	0.2	0.2	0.2	
+/- ^d	0	0	0	0	0	0	
Kr-82 (g) ^k	3.2765E-07	2.0508E-05	8.2597E-05	2.9454E-04	2.1310E-04	1.2482E-04	
+/- ^j	0.0000E+00	3.1140E-06	8.8471E-06	2.8347E-05	2.8998E-05	2.0806E-05	
Segment Total							
+/- ⁿ							
Kr-83 (mol%) ^d	15.1	15.1	15.1	15.1	15.1	15.1	
+/- ^d	0.1	0.1	0.1	0.1	0.1	0.1	
Kr-83 (g) ^k	2.5040E-05	1.5673E-03	6.3123E-03	2.2510E-02	1.6285E-02	9.5390E-03	
+/- ^j	1.6583E-07	2.3820E-04	6.7741E-04	2.1714E-03	2.2187E-03	1.5913E-03	
Segment Total							
+/- ⁿ							
Kr-84 (mol%) ^d	30.5	30.5	30.5	30.5	30.5	30.5	
+/- ^d	0.1	0.1	0.1	0.1	0.1	0.1	
Kr-84 (g) ^k	5.1186E-05	3.2037E-03	1.2903E-02	4.6014E-02	3.3290E-02	1.9499E-02	
+/- ^j	1.6782E-07	4.8658E-04	1.3827E-03	4.4309E-03	4.5314E-03	3.2510E-03	
Segment Total							
+/- ⁿ							

B-88

Rod "P" 0307602 (SI-1, 3N63)

	P-00	P-01	P-02	P-03	P-04	P-05	P-06
seg length (in) ^a	10.355	17.587	20.541	21.401	17.671	17.74	
total length (in)							
Kr-85 (mol%) ^d	5.7	5.7	5.7	5.7	5.7	5.7	
+/- ^d	0.1	0.1	0.1	0.1	0.1	0.1	
Kr-85 (g) ^k	9.6800E-06	6.0587E-04	2.4402E-03	8.7018E-03	6.2956E-03	3.6876E-03	1.9
+/- ^j	1.6982E-07	9.2610E-05	2.6486E-04	8.5125E-04	8.6380E-04	6.1808E-04	1.9
Segment Total							
+/- ⁿ							
Kr-86 (mol%) ^d	48.5	48.5	48.5	48.5	48.5	48.5	
+/- ^d	0.1	0.1	0.1	0.1	0.1	0.1	
Kr-86 (g) ^k	8.3333E-05	5.2158E-03	2.1007E-02	7.4912E-02	5.4197E-02	3.1746E-02	1.6
+/- ^j	1.7182E-07	7.9206E-04	2.2505E-03	7.2111E-03	7.3761E-03	5.2921E-03	1.6
Segment Total							
+/- ⁿ							
Rod Total							
+/- ⁿ							
shear gas (g) ^e	0	0.0001	0.0007	0.0078	0.0036	0.0012	
+/- ^e	0	0.0003	0.0003	0.0016	0.0007	0.0003	
moles Kr (diss+pl) ^d	0.000002	0.000125	0.000503	0.001785	0.001295	0.00076	
+/- ^d	0	0.000019	0.000054	0.000173	0.000177	0.000127	
Kr+Xe diss&pl (g) ^d	0.0012	0.0694	0.2999	1.0794	0.8133	0.4813	
+/- ^d	0	0.0085	0.0246	0.0787	0.0727	0.0439	
moles kr (tot) ^o	2.0000E-06	1.2518E-04	5.0417E-04	1.7979E-03	1.3007E-03	7.6189E-04	4.0
+/- ^p	0	1.9008E-05	5.4003E-05	1.7303E-04	1.7701E-04	1.2700E-04	4.0
Xe-128 (mol%) ^d	0.1	0.1	0.1	0.1	0.1	0.1	
+/- ^d	0	0	0	0	0	0	
Xe-128 (g) ^k	1.0232E-06	5.6102E-05	2.4564E-04	8.9033E-04	6.7305E-04	3.9800E-04	6.9
+/- ^j	0.0000E+00	8.0616E-06	2.3024E-05	7.3687E-05	6.7793E-05	4.0546E-05	6.9
SegmentTotal							
+/- ⁿ							

B-89

Rod "P" 0307602 (SI-1, 3N63)

	P-00	P-01	P-02	P-03	P-04	P-05	P-06
seg length (in) ^a	10.355	17.587	20.541	21.401	17.671	17.74	
total length (in)							
Xe-130 (mol%) ^d	0.2	0.2	0.2	0.2	0.2	0.2	
+/- ^d	0	0	0	0	0	0	
Xe-130 (g) ^k	2.0785E-06	1.1396E-04	4.9895E-04	1.8085E-03	1.3672E-03	8.0845E-04	
+/- ^j	0.0000E+00	1.6375E-05	4.6768E-05	1.4968E-04	1.3771E-04	8.2361E-05	
SegmentTotal							
+/- ⁿ							
Xe-131 (mol%) ^d	10.8	10.8	10.8	10.8	10.8	10.8	
+/- ^d	0.1	0.1	0.1	0.1	0.1	0.1	
Xe-131 (g) ^k	1.1310E-04	6.2013E-03	2.7151E-02	9.8412E-02	7.4396E-02	4.3993E-02	
+/- ^j	1.0472E-06	8.9293E-04	2.5573E-03	8.1958E-03	7.5250E-03	4.5002E-03	
SegmentTotal							
+/- ⁿ							
Xe-132 (mol%) ^d	23.1	23.1	23.1	23.1	23.1	23.1	
+/- ^d	0.1	0.1	0.1	0.1	0.1	0.1	
Xe-132 (g) ^k	2.4376E-04	1.3365E-02	5.8517E-02	2.1210E-01	1.6034E-01	9.4814E-02	
+/- ^j	1.0552E-06	1.9213E-03	5.4908E-03	1.7578E-02	1.6165E-02	9.6679E-03	
SegmentTotal							
+/- ⁿ							
Xe-134 (mol%) ^d	25.4	25.4	25.4	25.4	25.4	25.4	
+/- ^d	0.2	0.2	0.2	0.2	0.2	0.2	
Xe-134 (g) ^k	2.7210E-04	1.4919E-02	6.5319E-02	2.3676E-01	1.7898E-01	1.0584E-01	
+/- ^j	2.1425E-06	2.1469E-03	6.1441E-03	1.9683E-02	1.8082E-02	1.0814E-02	
SegmentTotal							
+/- ⁿ							

B-90

Rod "P" 0307602 (SI-1, 3N63)

	P-00	P-01	P-02	P-03	P-04	P-05	P-06
seg length (in) ^a	10.355	17.587	20.541	21.401	17.671	17.74	9
total length (in)							
Xe-136 (mol%) ^d	40.5	40.5	40.5	40.5	40.5	40.5	40.5
+/- ^d	0.2	0.2	0.2	0.2	0.2	0.2	0.2
Xe-136 (g) ^k	4.4034E-04	2.4143E-02	1.0571E-01	3.8315E-01	2.8964E-01	1.7128E-01	2.9723
+/- ^j	2.1745E-06	3.4713E-03	9.9220E-03	3.1767E-02	2.9209E-02	1.7469E-02	2.9723
SegmentTotal							
+/- ⁿ							
Rod total							
+/- ⁿ							
shear gas (g) ^e	0	0.0001	0.0007	0.0078	0.0036	0.0012	
+/- ^e	0	0.0003	0.0003	0.0016	0.0007	0.0003	0
moles Xe (diss+pl) ^d	0.000008	0.000438	0.001916	0.006911	0.005239	0.003104	0.00
+/- ^d	0	0.000063	0.00018	0.000576	0.00053	0.000317	0.00
Kr+Xe diss&pl (g) ^d	0.0012	0.0694	0.2999	1.0794	0.8133	0.4813	0
+/- ^d	0	0.0085	0.0246	0.0787	0.0727	0.0439	0
moles Xe (tot) ^o	8.0000E-06	4.3863E-04	1.9205E-03	6.9609E-03	5.2622E-03	3.1117E-03	5.4000
+/- ^p	0.0000E+00	6.3029E-05	1.8001E-04	5.7612E-04	5.3003E-04	3.1701E-04	5.4000
Values corrected to 1/1/84 (page 181, Final Report for the LWBR Proof of Breeding Analytical Support Project)							
Cs-137 (atoms) ^f	ND	4.5030E+19	2.2790E+20	1.0250E+21	7.0900E+20	3.8890E+20	3.7060
+/- ^f	NA	1.2730E+17	6.3350E+17	2.8410E+18	2.0180E+18	1.2050E+18	1.3160
Cs-137 (g) ^m	NA	1.0236E-02	5.1805E-02	2.3300E-01	1.6117E-01	8.8402E-02	8.4243
+/- ^m	NA	2.8937E-05	1.4400E-04	6.4580E-04	4.5872E-04	2.7391E-04	2.9915
Total							
+/- ⁿ							
Ce-144 (atoms) ^g	ND	1.6340E+18	1.0860E+19	4.2330E+19	4.1360E+19	3.4160E+19	5.9190
+/- ^g	NA	1.3350E+16	8.8560E+16	3.4500E+17	3.3810E+17	2.7450E+17	4.8580
Ce-144 (g) ^m	NA	3.9044E-04	2.5950E-03	1.0115E-02	9.8829E-03	8.1625E-03	1.4143
+/- ^m	NA	3.1900E-06	2.1161E-05	8.2437E-05	8.0788E-05	6.5591E-05	1.1608
Total							
+/- ⁿ							

B-91

Rod "P" 0307602 (SI-1, 3N63)

	P-00	P-01	P-02	P-03	P-04	P-05	P-06
seg length (in) ^a	10.355	17.587	20.541	21.401	17.671	17.74	
total length (in)							
Zr-95 (atoms) ^h	ND	ND	8.1620E+16	2.2340E+17	3.5710E+17	2.9840E+17	
+/- ^h	NA	NA	1.9020E+16	6.9930E+16	5.2060E+16	2.2610E+16	
Zr-95 (g) ^m	NA	NA	1.2862E-05	3.5204E-05	5.6272E-05	4.7022E-05	
+/- ^m	NA	NA	2.9972E-06	1.1020E-05	8.2037E-06	3.5629E-06	
Total							
+/- ⁿ							

Footnotes

- a. ANL Destructive Chemical Assay of 33-Rod LWBR EOL Sample - Rod P, 0307602, page 3
- b. ANL Destructive Chemical Assay of 33-Rod LWBR EOL Sample - Rod P, 0307602, page 6
- c. ANL Destructive Chemical Assay of 33-Rod LWBR EOL Sample - Rod P, 0307602, page 7
- d. ANL Destructive Chemical Assay of 33-Rod LWBR EOL Sample - Rod P, 0307602, page 10
- e. ANL Destructive Chemical Assay of 33-Rod LWBR EOL Sample - Rod P, 0307602, page 11
- f. ANL Destructive Chemical Assay of 33-Rod LWBR EOL Sample - Rod P, 0307602, page 12
- g. ANL Destructive Chemical Assay of 33-Rod LWBR EOL Sample - Rod P, 0307602, page 13
- h. ANL Destructive Chemical Assay of 33-Rod LWBR EOL Sample - Rod P, 0307602, page 14
- i. (abundance of the specified isotope)(total weight of uranium) / 100
- j. Error Propagation = $((sd_x/x)^2 + (sd_y/y)^2)^{1/2}(xy)$, where sd is the +/- in the table
- k. (mole%)(number moles gas recovered)(molec wt) / 100
- m. (number of atoms per segment)(atomic weight) / 6.0228E+23
- n. Error Propagation = $(\sum(sd_i^2))^{1/2}$, where sd is the +/- in the table
- o. ((shear gas / Xe + Kr (diss&pl)))(moles Xe or Kr (diss + pl)) + moles Xe or Kr (diss + pl)
- p. Error Propagation = $((((sd_x/x)^2 + (sd_y/y)^2 + (sd_z/z)^2)^{1/2} (xy/z))^2 + (sd_y)^2)^{1/2}$, where sd is the +/- in the table

Rod "Q" 0401744 (SI-1, 4M49)

	Q-00	Q-01	Q-02	Q-03	Q-04	Q-05	Q-06
seg length (in) ^a	11.29	24.915	17.858	17.655	17.655	17.727	
total length (in)							
U-232 wt% ^b	0	0.1456	0.1369	0.1673	0.1306	0.0415	0
+/- ^b	0	0.0045	0.0042	0.0052	0.004	0.0013	0
U-232 g ⁱ	0.0000E+00	2.1672E-03	5.7479E-03	7.0670E-03	5.8779E-03	2.1102E-03	4.563
+/- ^j	NA	6.6983E-05	1.7635E-04	2.1966E-04	1.8004E-04	6.6106E-05	1.472
Segment Total							
+/- ⁿ							
U-233 wt% ^b	100	93.9175	82.8697	82.2492	85.317	92.1545	98
+/- ^b	0	0.0078	0.0084	0.0083	0.0075	0.0072	0
U-233 g ⁱ	4.0000E-05	1.3979E+00	3.4794E+00	3.4743E+00	3.8399E+00	4.6860E+00	1.805
+/- ^j	1.0000E-05	3.8424E-04	1.1100E-03	1.1096E-03	1.1675E-03	1.4211E-03	8.892
Segment Total							
+/- ⁿ							
U-234 wt% ^b	0	5.294	13.6937	14.1381	11.8792	6.591	1
+/- ^b	0	0.001	0.0019	0.0019	0.0015	0.001	0
U-234 g ⁱ	0.0000E+00	7.8799E-02	5.7495E-01	5.9721E-01	5.3465E-01	3.3515E-01	3.249
+/- ^j	NA	2.5453E-05	1.9133E-04	1.9797E-04	1.6963E-04	1.1059E-04	2.468
Segment Total							
+/- ⁿ							
U-235 wt% ^b	0	0.6084	2.6275	2.7636	2.1068	0.7896	0
+/- ^b	0	0.005	0.0064	0.0059	0.0055	0.0055	0
U-235 g ⁱ	0.0000E+00	9.0557E-03	1.1032E-01	1.1674E-01	9.4821E-02	4.0150E-02	1.113
+/- ^j	NA	7.4460E-05	2.7078E-04	2.5172E-04	2.4907E-04	2.7992E-04	3.017
Segment Total							
+/- ⁿ							
U-236 wt% ^b	0	0.0301	0.2464	0.2738	0.172	0.0375	0
+/- ^b	0	0.0001	0.0001	0.0001	0.0001	0.0001	0
U-236 g ⁱ	0.0000E+00	4.4802E-04	1.0345E-02	1.1566E-02	7.7412E-03	1.9068E-03	2.207
+/- ^j	NA	1.4931E-06	5.2365E-06	5.4887E-06	5.0332E-06	5.1155E-06	1.839
Segment Total							
+/- ⁿ							

Rod "Q" 0401744 (SI-1, 4M49)

	Q-00	Q-01	Q-02	Q-03	Q-04	Q-05	Q-06
seg length (in) ^a	11.29	24.915	17.858	17.655	17.655	17.727	
total length (in)							
U-238 wt% ^b	0	0.0044	0.4258	0.408	0.3944	0.3858	
+/- ^b	0	0.0048	0.0063	0.0059	0.0053	0.0053	
U-238 g ⁱ	0.0000E+00	6.5492E-05	1.7878E-02	1.7234E-02	1.7751E-02	1.9618E-02	3.0
+/- ^j	NA	7.1446E-05	2.6457E-04	2.4928E-04	2.3859E-04	2.6956E-04	2.9
Segment Total							
+/- ⁿ							
tot U ^c	0.00008	1.48845	4.19863	4.22412	4.50069	5.08489	
+/- ^c	0.00001	0.00039	0.00127	0.00128	0.00131	0.00149	
Kr-82 (mol%) ^d	0.2	0.2	0.2	0.2	0.2	0.2	
+/- ^d	0	0	0	0	0	0	
Kr-82 (g) ^k	1.3106E-06	2.9873E-05	2.3273E-04	2.5732E-04	1.9262E-04	1.1320E-04	0.0
+/- ^j	0.0000E+00	4.9156E-06	1.2291E-05	3.0639E-05	3.0309E-05	2.0479E-05	NA
Segment Total							
+/- ⁿ							
Kr-83 (mol%) ^d	15.2	15.2	15.2	15.2	15.2	15.2	
+/- ^d	0.2	0.2	0.2	0.2	0.2	0.2	
Kr-83 (g) ^k	1.0082E-04	2.2981E-03	1.7904E-02	1.9795E-02	1.4818E-02	8.7082E-03	0.0
+/- ^j	1.3266E-06	3.7935E-04	9.7443E-04	2.3714E-03	2.3398E-03	1.5796E-03	NA
Segment Total							
+/- ⁿ							
Kr-84 (mol%) ^d	30.6	30.6	30.6	30.6	30.6	30.6	
+/- ^d	0.2	0.2	0.2	0.2	0.2	0.2	
Kr-84 (g) ^k	2.0542E-04	4.6821E-03	3.6476E-02	4.0330E-02	3.0190E-02	1.7742E-02	0.0
+/- ^j	1.3426E-06	7.7103E-04	1.9411E-03	4.8094E-03	4.7545E-03	3.2118E-03	NA
Segment Total							
+/- ⁿ							

B-94

Rod "Q" 0401744 (SI-1, 4M49)

	Q-00	Q-01	Q-02	Q-03	Q-04	Q-05	Q-06
seg length (in) ^a	11.29	24.915	17.858	17.655	17.655	17.727	
total length (in)							
Kr-85 (mol%) ^d	5.7	5.7	5.7	5.7	5.7	5.7	5.7
+/- ^d	0.1	0.1	0.1	0.1	0.1	0.1	0.1
Kr-85 (g) ^k	3.8720E-05	8.8255E-04	6.8756E-03	7.6021E-03	5.6906E-03	3.3443E-03	0.00
+/- ^j	6.7930E-07	1.4605E-04	3.8263E-04	9.1496E-04	9.0099E-04	6.0785E-04	NA
Segment Total							
+/- ⁿ							
Kr-86 (mol%) ^d	48.3	48.3	48.3	48.3	48.3	48.3	48.3
+/- ^d	0.2	0.2	0.2	0.2	0.2	0.2	0.2
Kr-86 (g) ^k	3.3196E-04	7.5664E-03	5.8947E-02	6.5175E-02	4.8788E-02	2.8672E-02	0.00
+/- ^j	1.3746E-06	1.2454E-03	3.1227E-03	7.7651E-03	7.6796E-03	5.1883E-03	NA
Segment Total							
+/- ⁿ							
Rod Total							
+/- ⁿ							
shear gas (g) ^e	0	0.0002	0.0053	0.0072	0.0042	0.0012	
+/- ^e	0	0.0003	0.0011	0.0014	0.0008	0.0003	
moles Kr (diss+pl) ^d	0.000008	0.000182	0.001412	0.001559	0.001169	0.000689	
+/- ^d	0	0.00003	0.000075	0.000187	0.000185	0.000125	
Kr+Xe diss&pl (g) ^d	0.0046	0.1053	0.8716	0.961	0.7272	0.42	
+/- ^d	0.0002	0.0165	0.0462	0.0852	0.068	0.0353	
moles kr (tot) ^o	8.0000E-06	1.8235E-04	1.4206E-03	1.5707E-03	1.1758E-03	6.9097E-04	
+/- ^p	0.0000E+00	3.0005E-05	7.5024E-05	1.8702E-04	1.8501E-04	1.2500E-04	
Xe-128 (mol%) ^d	0.1	0.1	0.1	0.1	0.1	0.1	0.1
+/- ^d	0	0	0	0	0	0	0
Xe-128 (g) ^k	3.8371E-06	8.5730E-05	7.2062E-04	7.9546E-04	6.0179E-04	3.4543E-04	0.00
+/- ^j	1.2790E-07	1.5606E-05	3.8000E-05	7.9696E-05	6.2934E-05	3.1977E-05	NA
SegmentTotal							
+/- ⁿ							

B-95

Rod "Q" 0401744 (SI-1, 4M49)

	Q-00	Q-01	Q-02	Q-03	Q-04	Q-05	C
seg length (in) ^a	11.29	24.915	17.858	17.655	17.655	17.727	
total length (in)							
Xe-130 (mol%) ^d	0.2	0.2	0.2	0.2	0.2	0.2	
+/- ^d	0	0	0	0	0	0	
Xe-130 (g) ^k	7.7942E-06	1.7414E-04	1.4638E-03	1.6158E-03	1.2224E-03	7.0166E-04	
+/- ^j	2.5981E-07	3.1700E-05	7.7187E-05	1.6188E-04	1.2784E-04	6.4954E-05	
SegmentTotal							
+/- ⁿ							
Xe-131 (mol%) ^d	10.9	10.9	10.9	10.9	10.9	10.9	
+/- ^d	0.1	0.1	0.1	0.1	0.1	0.1	
Xe-131 (g) ^k	4.2806E-04	9.5639E-03	8.0390E-02	8.8740E-02	6.7134E-02	3.8535E-02	
+/- ^j	1.4799E-05	1.7432E-03	4.3028E-03	8.9279E-03	7.0477E-03	3.5848E-03	
SegmentTotal							
+/- ⁿ							
Xe-132 (mol%) ^d	23.3	23.3	23.3	23.3	23.3	23.3	
+/- ^d	0.1	0.1	0.1	0.1	0.1	0.1	
Xe-132 (g) ^k	9.2201E-04	2.0600E-02	1.7316E-01	1.9114E-01	1.4460E-01	8.3002E-02	
+/- ^j	3.0987E-05	3.7510E-03	9.1610E-03	1.9168E-02	1.5135E-02	7.6920E-03	
SegmentTotal							
+/- ⁿ							
Xe-134 (mol%) ^d	25.4	25.4	25.4	25.4	25.4	25.4	
+/- ^d	0.1	0.1	0.1	0.1	0.1	0.1	
Xe-134 (g) ^k	1.0204E-03	2.2797E-02	1.9163E-01	2.1153E-01	1.6003E-01	9.1856E-02	
+/- ^j	3.4248E-05	4.1510E-03	1.0133E-02	2.1209E-02	1.6747E-02	8.5110E-03	
SegmentTotal							
+/- ⁿ							

B-96

Rod "Q" 0401744 (SI-1, 4M49)

	Q-00	Q-01	Q-02	Q-03	Q-04	Q-05	Q-06
seg length (in) ^a	11.29	24.915	17.858	17.655	17.655	17.727	
total length (in)							
Xe-136 (mol%) ^d	40.2	40.2	40.2	40.2	40.2	40.2	
+/- ^d	0.2	0.2	0.2	0.2	0.2	0.2	
Xe-136 (g) ^k	1.6390E-03	3.6620E-02	3.0781E-01	3.3979E-01	2.5706E-01	1.4755E-01	0.0000
+/- ^j	5.5240E-05	6.6688E-03	1.6304E-02	3.4085E-02	2.6913E-02	1.3679E-02	NA
SegmentTotal							
+/- ⁿ							
Rod total							
+/- ⁿ							
shear gas (g) ^e	0	0.0002	0.0053	0.0072	0.0042	0.0012	
+/- ^e	0	0.0003	0.0011	0.0014	0.0008	0.0003	0
moles Xe (diss+pl) ^d	0.00003	0.000669	0.0056	0.006173	0.004678	0.002693	
+/- ^d	0.000001	0.000122	0.000297	0.000623	0.000492	0.00025	
Kr+Xe diss&pl (g) ^d	0.0046	0.1053	0.8716	0.961	0.7272	0.42	
+/- ^d	0.0002	0.0165	0.0462	0.0852	0.068	0.0353	
moles Xe (tot) ^o	3.0000E-05	6.7027E-04	5.6341E-03	6.2192E-03	4.7050E-03	2.7007E-03	
+/- ^p	1.0000E-06	1.2202E-04	2.9710E-04	6.2310E-04	4.9204E-04	2.5001E-04	
Values corrected to 1/1/84 (page 181, Final Report for the LWBR Proof of Breeding Analytical Support Project)							
Cs-137 (atoms) ^f	ND	9.0070E+19	7.6440E+20	8.0030E+20	6.8580E+20	3.7140E+20	3.7300
+/- ^f	NA	2.3610E+17	2.0670E+18	2.1670E+18	1.8530E+18	1.1050E+18	1.2820
Cs-137 (g) ^m	NA	2.0474E-02	1.7376E-01	1.8192E-01	1.5589E-01	8.4424E-02	8.478
+/- ^m	NA	5.3669E-05	4.6986E-04	4.9259E-04	4.2121E-04	2.5118E-04	2.914
Total							
+/- ⁿ							
Ce-144 (atoms) ^g	ND	3.4940E+18	2.4120E+19	3.4990E+19	3.9930E+19	3.2300E+19	5.8480
+/- ^g	NA	2.2970E+16	1.6830E+17	2.5880E+17	2.7060E+17	2.1900E+17	3.9860
Ce-144 (g) ^m	NA	8.3488E-04	5.7634E-03	8.3608E-03	9.5412E-03	7.7180E-03	1.397
+/- ^m	NA	5.4886E-06	4.0215E-05	6.1840E-05	6.4659E-05	5.2330E-05	9.524
Total							
+/- ⁿ							

B-97

Rod "Q" 0401744 (SI-1, 4M49)

	Q-00	Q-01	Q-02	Q-03	Q-04	Q-05	Q-06
seg length (in) ^a	11.29	24.915	17.858	17.655	17.655	17.727	
total length (in)							
Zr-95 (atoms) ^h	ND	ND	1.6040E+17	2.1710E+17	2.8820E+17	3.4550E+17	
+/- ^h	NA	NA	4.6110E+16	6.2070E+16	6.6950E+16	3.4900E+16	
Zr-95 (g) ^m	NA	NA	2.5276E-05	3.4211E-05	4.5415E-05	5.4444E-05	
+/- ^m	NA	NA	7.2661E-06	9.7811E-06	1.0550E-05	5.4996E-06	
Total							
+/- ⁿ							

Footnotes

- a. ANL Destructive Chemical Assay of 33-Rod LWBR EOL Sample - Rod Q, 0401744, page 3
- b. ANL Destructive Chemical Assay of 33-Rod LWBR EOL Sample - Rod Q, 0401744, page 6
- c. ANL Destructive Chemical Assay of 33-Rod LWBR EOL Sample - Rod Q, 0401744 , page 7
- d. ANL Destructive Chemical Assay of 33-Rod LWBR EOL Sample - Rod Q, 0401744, page 10
- e. ANL Destructive Chemical Assay of 33-Rod LWBR EOL Sample - Rod Q, 0401744, page 11
- f. ANL Destructive Chemical Assay of 33-Rod LWBR EOL Sample - Rod Q, 0401744, page 12
- g. ANL Destructive Chemical Assay of 33-Rod LWBR EOL Sample - Rod Q, 0401744, page 13
- h. ANL Destructive Chemical Assay of 33-Rod LWBR EOL Sample - Rod Q, 0401744, page 14
- i. (abundance of the specified isotope)(total weight of uranium) / 100
- j. Error Propagation = $((sd_x/x)^2 + (sd_y/y)^2)^{1/2} (xy)$, where sd is the +/- in the table
- k. (mole%)(number moles gas recovered)(molec wt) / 100
- m. (number of atoms per segment)(atomic weight) / 6.0228E+23
- n. Error Propagation = $(\sum(sd_i^2))^{1/2}$, where sd is the +/- in the table
- o. $((\text{shear gas} / \text{Xe} + \text{Kr} (\text{diss} + \text{pl}))) (\text{moles Xe or Kr} (\text{diss} + \text{pl})) + \text{moles Xe or Kr} (\text{diss} + \text{pl})$
- p. Error Propagation = $((((sd_x/x)^2 + (sd_y/y)^2 + (sd_z/z)^2)^{1/2} (xy/z))^2 + (sd_y)^2)^{1/2}$, where sd is the +/- in the table

Rod "R" 3110505 (RV-3 E3)														
	R-00	R-01	R-02	R-03	R-04	R-05	R-06	R-07	R-08	R-09	R-10	R-11	R-12	R-13
seg length (in) ^a	6.181	3.278	7.001	6.996	7.004	7	7	6.998	6.986	7.015	6.979	7.02	7.003	
total length (in)														
U-232 wt% ^b	0	0.0019	0.0082	0.0212	0.0361	0.0522	0.0642	0.0721	0.0763	0.074	0.0707	0.0606	0.0463	
+ μ^b	0	0.0001	0.0003	0.0007	0.0011	0.0016	0.002	0.0022	0.0024	0.0023	0.0022	0.0019	0.0014	
U-232 g ^l	0.0000E+00	9.6919E-07	3.1067E-05	2.0065E-04	5.4060E-04	1.0930E-03	1.5802E-03	1.8943E-03	2.1156E-03	1.9808E-03	1.8423E-03	1.4205E-03	8.5330E-04	3.7
+ μ^l	NA	5.1027E-08	1.1366E-06	6.6255E-06	1.6473E-05	3.3504E-05	4.9229E-05	5.7803E-05	6.6546E-05	6.1567E-05	5.7330E-05	4.4537E-05	2.5802E-05	1.1
Segment Total														
+ μ^s														
U-233 wt% ^b	100	99.7066	99.4487	98.7621	98.0395	97.1846	96.59	96.3164	96.0604	96.2585	96.3287	96.7773	97.5244	
+ μ^b	0	0.124	0.0168	0.0085	0.008	0.0075	0.0074	0.0079	0.0091	0.0082	0.0075	0.0085	0.0079	
U-233 g ^l	4.0000E-05	5.0860E-02	3.7678E-01	9.3476E-01	1.4682E+00	2.0350E+00	2.3775E+00	2.5306E+00	2.6635E+00	2.5766E+00	2.5102E+00	2.2685E+00	1.7973E+00	1.2
+ μ^l	1.0000E-05	9.4192E-05	1.0983E-04	2.2246E-04	3.6345E-04	5.2920E-04	5.2520E-04	5.6895E-04	6.4682E-04	5.9990E-04	5.6471E-04	5.3226E-04	4.6238E-04	3.1
Segment Total														
+ μ^s														
U-234 wt% ^b	0	0.1424	0.505	1.1737	1.8414	2.6077	3.1227	3.3492	3.5739	3.4003	3.347	2.9629	2.2988	
+ μ^b	0	0.003	0.0003	0.0003	0.0003	0.0004	0.0004	0.0004	0.0005	0.0004	0.0004	0.0004	0.0003	
U-234 g ^l	0.0000E+00	7.2638E-05	1.9133E-03	1.1109E-02	2.7575E-02	5.4603E-02	7.6862E-02	8.7995E-02	9.9094E-02	9.1018E-02	8.7218E-02	6.9450E-02	4.2366E-02	2.0
+ μ^l	NA	1.5335E-06	1.2241E-06	3.7600E-06	7.8562E-06	1.5938E-05	1.8723E-05	2.1208E-05	2.6138E-05	2.2441E-05	2.1155E-05	1.7783E-05	1.1729E-05	6.1
Segment Total														
+ μ^s														
U-235 wt% ^b	0	0.0029	0.0067	0.0311	0.0751	0.1482	0.2135	0.2521	0.2784	0.2564	0.2431	0.1901	0.1228	
+ μ^b	0	0.0882	0.012	0.0062	0.0058	0.0055	0.0053	0.0056	0.0066	0.0059	0.0054	0.0061	0.0057	
U-235 g ^l	0.0000E+00	1.4793E-06	2.5384E-05	2.9436E-04	1.1246E-03	3.1032E-03	5.2551E-03	6.6235E-03	7.7192E-03	6.8632E-03	6.3348E-03	4.4559E-03	2.2632E-03	7.3
+ μ^l	NA	4.4991E-05	4.5464E-05	5.8682E-05	8.6856E-05	1.1517E-04	1.3046E-04	1.4714E-04	1.8301E-04	1.5794E-04	1.4072E-04	1.4299E-04	1.0505E-04	8.7
Segment Total														
+ μ^s														
U-236 wt% ^b	0	0.0001	0.0002	0.0003	0.001	0.0025	0.0047	0.0058	0.0071	0.0064	0.0059	0.004	0.0019	
+ μ^b	0	0.0002	0.0001	0.0001	0.0001	0.0001	0.0001	0.0001	0.0001	0.0001	0.0001	0.0001	0.0001	
U-236 g ^l	0.0000E+00	5.1010E-08	7.5774E-07	2.8394E-06	1.4975E-05	5.2348E-05	1.1569E-04	1.5239E-04	1.9686E-04	1.7131E-04	1.5375E-04	9.3760E-05	3.5016E-05	1.0
+ μ^l	NA	1.0202E-07	3.7887E-07	9.4648E-07	1.4975E-06	2.0940E-06	2.4615E-06	2.6275E-06	2.7730E-06	2.6770E-06	2.6061E-06	2.3441E-06	1.8430E-06	1.2
Segment Total														
+ μ^s														
U-238 wt% ^b	0	0.1462	0.0312	0.0116	0.0069	0.0048	0.0048	0.0044	0.0039	0.0045	0.0046	0.005	0.0058	
+ μ^b	0	0.0875	0.0118	0.006	0.0056	0.0053	0.0051	0.0054	0.0064	0.0057	0.0052	0.006	0.0055	
U-238 g ^l	0.0000E+00	7.4577E-05	1.1821E-04	1.0979E-04	1.0333E-04	1.0051E-04	1.1815E-04	1.1560E-04	1.0814E-04	1.2045E-04	1.1987E-04	1.1720E-04	1.0689E-04	1.1
+ μ^l	NA	4.4634E-05	4.4707E-05	5.6789E-05	8.3861E-05	1.1098E-04	1.2553E-04	1.4188E-04	1.7745E-04	1.5257E-04	1.3550E-04	1.4064E-04	1.0136E-04	8.4
Segment Total														
+ μ^s														
tot U ^c	0.00003	0.05101	0.37887	0.94648	1.49751	2.09391	2.46141	2.62735	2.7727	2.67675	2.60586	2.34399	1.84297	
+ μ^c	0.00001	0.00007	0.00009	0.00021	0.00035	0.00052	0.00051	0.00055	0.00062	0.00058	0.00055	0.00051	0.00045	

B-99

Rod "R" 3110505 (RV-3 E3)

	R-00	R-01	R-02	R-03	R-04	R-05	R-06	R-07	R-08	R-09	R-10	R-11	R-12	R-13
seg length (in) ^a	6.181	3.278	7.001	6.996	7.004	7	7	6.998	6.986	7.015	6.979	7.02	7.003	6
total length (in)														
Kr-82 (mol%) ^d														
+f ^d														
Kr-82 (g) ^b	0.0000E+00	0.0000E+00	0.0000E+00	0.0000E+00	0.0000E+00	0.0000E+00	0.0000E+00	0.0000E+00	0.0000E+00	0.0000E+00	0.0000E+00	0.0000E+00	0.0000E+00	0.0000E+00
+f ¹	NA	NA	NA	NA	NA	NA	NA	NA	NA	NA	NA	NA	NA	NA
Segment Total														
+f ¹														
Kr-83 (mol%) ^d														
+f ^d														
Kr-83 (g) ^b	0.000E+00	0.000E+00	0.000E+00	0.000E+00	0.000E+00	0.000E+00	0.000E+00	0.000E+00	0.000E+00	0.000E+00	0.000E+00	0.000E+00	0.000E+00	0.000E+00
+f ¹	NA	NA	NA	NA	NA	NA	NA	NA	NA	NA	NA	NA	NA	NA
Segment Total														
+f ¹														
Kr-84 (mol%) ^d														
+f ^d														
Kr-84 (g) ^b	0.0000E+00	0.0000E+00	0.0000E+00	0.0000E+00	0.0000E+00	0.0000E+00	0.0000E+00	0.0000E+00	0.0000E+00	0.0000E+00	0.0000E+00	0.0000E+00	0.0000E+00	0.0000E+00
+f ¹	NA	NA	NA	NA	NA	NA	NA	NA	NA	NA	NA	NA	NA	NA
Segment Total														
+f ¹														
Kr-85 (mol%) ^d														
+f ^d														
Kr-85 (g) ^b	0.0000E+00	0.0000E+00	0.0000E+00	0.0000E+00	0.0000E+00	0.0000E+00	0.0000E+00	0.0000E+00	0.0000E+00	0.0000E+00	0.0000E+00	0.0000E+00	0.0000E+00	0.0000E+00
+f ¹	NA	NA	NA	NA	NA	NA	NA	NA	NA	NA	NA	NA	NA	NA
Segment Total														
+f ¹														
Kr-86 (mol%) ^d														
+f ^d														
Kr-86 (g) ^b	0.0000E+00	0.0000E+00	0.0000E+00	0.0000E+00	0.0000E+00	0.0000E+00	0.0000E+00	0.0000E+00	0.0000E+00	0.0000E+00	0.0000E+00	0.0000E+00	0.0000E+00	0.0000E+00
+f ¹	NA	NA	NA	NA	NA	NA	NA	NA	NA	NA	NA	NA	NA	NA
Segment Total														
+f ¹														
Rod Total														
+f ¹														
shear gas (g) ^b														
+f ⁶														
moles Kr (diss+pl) ^d														
+f ^d														
Kr+Xe diss&pl (g) ^d														
+f ^d														
moles kr (tot) ^o														
+f ^p														

Rod "R" 3110505 (RV-3 E3)														
	R-00	R-01	R-02	R-03	R-04	R-05	R-06	R-07	R-08	R-09	R-10	R-11	R-12	R-13
seg length (in) ^a	6.181	3.278	7.001	6.996	7.004	7	7	6.998	6.986	7.015	6.979	7.02	7.003	
total length (in)														
Kr-82 (mol%) ^d														
+f ^d														
Kr-82 (g) ^b	0.0000E+00	0.0000E+00	0.0000E+00	0.0000E+00	0.0000E+00	0.0000E+00	0.0000E+00	0.0000E+00	0.0000E+00	0.0000E+00	0.0000E+00	0.0000E+00	0.0000E+00	0.0000E+00
+f ^l	NA	NA	NA	NA	NA	NA	NA	NA	NA	NA	NA	NA	NA	NA
Segment Total														
+f ^l														
Kr-83 (mol%) ^d														
+f ^d														
Kr-83 (g) ^b	0.000E+00	0.000E+00	0.000E+00	0.000E+00	0.000E+00	0.000E+00	0.000E+00	0.000E+00	0.000E+00	0.000E+00	0.000E+00	0.000E+00	0.000E+00	0.000E+00
+f ^l	NA	NA	NA	NA	NA	NA	NA	NA	NA	NA	NA	NA	NA	NA
Segment Total														
+f ^l														
Kr-84 (mol%) ^d														
+f ^d														
Kr-84 (g) ^b	0.0000E+00	0.0000E+00	0.0000E+00	0.0000E+00	0.0000E+00	0.0000E+00	0.0000E+00	0.0000E+00	0.0000E+00	0.0000E+00	0.0000E+00	0.0000E+00	0.0000E+00	0.0000E+00
+f ^l	NA	NA	NA	NA	NA	NA	NA	NA	NA	NA	NA	NA	NA	NA
Segment Total														
+f ^l														
Kr-85 (mol%) ^d														
+f ^d														
Kr-85 (g) ^b	0.0000E+00	0.0000E+00	0.0000E+00	0.0000E+00	0.0000E+00	0.0000E+00	0.0000E+00	0.0000E+00	0.0000E+00	0.0000E+00	0.0000E+00	0.0000E+00	0.0000E+00	0.0000E+00
+f ^l	NA	NA	NA	NA	NA	NA	NA	NA	NA	NA	NA	NA	NA	NA
Segment Total														
+f ^l														
Kr-86 (mol%) ^d														
+f ^d														
Kr-86 (g) ^b	0.0000E+00	0.0000E+00	0.0000E+00	0.0000E+00	0.0000E+00	0.0000E+00	0.0000E+00	0.0000E+00	0.0000E+00	0.0000E+00	0.0000E+00	0.0000E+00	0.0000E+00	0.0000E+00
+f ^l	NA	NA	NA	NA	NA	NA	NA	NA	NA	NA	NA	NA	NA	NA
Segment Total														
+f ^l														
Rod Total														
+f ^l														
shear gas (g) ^c														
+f ^l														
moles Kr (diss+pl) ^d														
+f ^d														
Kr+Xe diss&pl (g) ^d														
+f ^d														
moles kr (tot) ^o														
+f ^p														

B-101

Rod "R" 3110505 (RIV-3 E3)														
	R-00	R-01	R-02	R-03	R-04	R-05	R-06	R-07	R-08	R-09	R-10	R-11	R-12	R-
seg length (in) ^a	6.181	3.278	7.001	6.996	7.004	7	7	6.998	6.986	7.015	6.979	7.02	7.003	
total length (in)														
Values corrected to 1/1/84 (page 181, Final Report for the LWBR Proof of Breeding Analytical Support Project)														
Cs-137 (atoms) ^f	ND	1.3540E+17	2.6310E+18	1.3750E+19	3.2750E+19	6.4150E+19	8.9490E+19	1.0160E+20	1.1500E+20	1.0510E+20	1.0180E+20	8.0930E+19	4.9090E+19	2
+/- ^f	NA	5.0590E+14	7.3040E+15	3.8140E+16	9.0500E+16	1.6950E+17	2.4900E+17	2.8250E+17	3.1980E+17	2.7740E+17	2.8320E+17	2.2580E+17	1.3650E+17	6
Cs-137 (g) ^h	NA	3.0778E-05	5.9806E-04	3.1256E-03	7.4445E-03	1.4582E-02	2.0342E-02	2.3095E-02	2.6141E-02	2.3891E-02	2.3141E-02	1.8397E-02	1.1159E-02	5
+/- ^h	NA	1.1500E-07	1.6603E-06	8.6698E-06	2.0572E-05	3.8530E-05	5.6601E-05	6.4216E-05	7.2695E-05	6.3057E-05	6.4375E-05	5.1328E-05	3.1028E-05	1
Total														
+/- ^h														
Ce-144 (atoms) ^g	ND	1.7900E+16	3.1740E+17	1.4680E+18	3.1380E+18	5.5920E+18	7.3100E+18	8.1310E+18	9.1680E+18	8.3640E+18	7.7760E+18	5.8990E+18	3.3750E+18	1
+/- ^g	NA	1.9640E+14	2.4250E+15	1.1220E+16	2.3520E+16	4.1910E+16	5.6940E+16	6.3340E+16	6.8700E+16	6.3920E+16	5.9440E+16	4.5960E+16	2.6290E+16	1
Ce-144 (g) ^h	NA	4.2772E-06	7.5842E-05	3.5078E-04	7.4982E-04	1.3362E-03	1.7467E-03	1.9429E-03	2.1907E-03	1.9986E-03	1.8581E-03	1.4096E-03	8.0645E-04	3
+/- ^h	NA	4.6929E-08	5.7945E-07	2.6810E-06	5.6201E-06	1.0014E-05	1.3606E-05	1.5135E-05	1.6416E-05	1.5274E-05	1.4203E-05	1.0982E-05	6.2819E-06	2
Total														
+/- ^h														
Zr-95 (atoms) ⁱ	ND	ND	4.3710E+15	1.6040E+16	2.9090E+16	5.8980E+16	7.5130E+16	8.7750E+16	9.0530E+16	7.1950E+16	4.7500E+16	4.7420E+16	2.1220E+16	ND
+/- ⁱ	NA	NA	4.3500E+14	1.0600E+15	3.1900E+15	5.3760E+15	6.0600E+15	7.4730E+15	9.8490E+15	8.1450E+15	7.0460E+15	6.7800E+15	3.2150E+15	NA
Zr-95 (g) ^h	NA	NA	6.8879E-07	2.5276E-06	4.5840E-06	9.2941E-06	1.1839E-05	1.3828E-05	1.4266E-05	1.1338E-05	7.4851E-06	7.4725E-06	3.3439E-06	NA
+/- ^h	NA	NA	6.8548E-08	1.6704E-07	5.0268E-07	8.4716E-07	9.5494E-07	1.1776E-06	1.5520E-06	1.2835E-06	1.1103E-06	1.0684E-06	5.0662E-07	NA
Total														
+/- ^h														

Footnotes

- ANL Destructive Chemical Assay of 33-Rod LWBR EOL Sample - Rod R, 3110505, page 4
- ANL Destructive Chemical Assay of 33-Rod LWBR EOL Sample - Rod R, 3110505, page 7
- ANL Destructive Chemical Assay of 33-Rod LWBR EOL Sample - Rod R, 3110505, page 8
- ANL Destructive Chemical Assay of 33-Rod LWBR EOL Sample - Rod R, 3110505, page 11
- ANL Destructive Chemical Assay of 33-Rod LWBR EOL Sample - Rod R, 3110505, page 12
- ANL Destructive Chemical Assay of 33-Rod LWBR EOL Sample - Rod R, 3110505, page 13
- ANL Destructive Chemical Assay of 33-Rod LWBR EOL Sample - Rod R, 3110505, page 14
- ANL Destructive Chemical Assay of 33-Rod LWBR EOL Sample - Rod R, 3110505, page 15
- (abundance of the specified isotope)(total weight of uranium) / 100
- Error Propagation = $((sd_x/x)^2 + (sd_y/y)^2)^{1/2}(xy)$, where sd is the +/- in the table
- (mole%)(number moles gas recovered)(molec wt) / 100
- (number of atoms per segment)(atomic weight) / 6.0228E+23
- Error Propagation = $(\sum(sd_i^2))^{1/2}$, where sd is the +/- in the table
- $((\text{shear gas} / \text{Xe} + \text{Kr}(\text{diss}\&\text{pl}))) (\text{moles Xe or Kr}(\text{diss} + \text{pl})) + \text{moles Xe or Kr}(\text{diss} + \text{pl})$
- Error Propagation = $((((sd_x/x)^2 + (sd_y/y)^2 + (sd_z/z)^2)^{1/2}(xyz/z))^2 + (sd_z/z)^2)^{1/2}$, where sd is the +/- in the table

Rod "W" 2514716 Calibration

	W-00	W-01	W-02	W-03	W-04	W-05
seg length (in) ^a	3.7	17.498	17.501	17.498	17.504	6.846
total length (in)						8.0547E+01
U-232 wt% ^b		0.00073	0.00061	0.00058	0.00074	
+/- ^b		0.00002	0.00002	0.00002	0.00002	
U-232 g ⁱ		2.3396E-05	1.0216E-05	9.7224E-06	2.3689E-05	
+/- ^j		6.4100E-07	3.3500E-07	3.3527E-07	6.4026E-07	
Segment Total						6.7022E-05
+/- ⁿ						1.0225E-06
U-233 wt% ^b		98.3346	97.7203	97.7221	98.3331	
+/- ^b		0.0061	0.0274	0.0094	0.0063	
U-233 g ⁱ		3.1515E+00	1.6365E+00	1.6381E+00	3.1478E+00	
+/- ^j		8.4883E-04	1.1419E-03	4.6713E-04	8.5026E-04	
Segment Total						9.5739E+00
+/- ⁿ						1.7221E-03
U-234 wt% ^b		1.3063	1.1589	1.1576	1.307	
+/- ^b		0.0002	0.0005	0.0002	0.0002	
U-234 g ⁱ		4.1865E-02	1.9408E-02	1.9405E-02	4.1839E-02	
+/- ^j		1.2708E-05	1.4963E-05	6.1948E-06	1.2709E-05	
Segment Total						1.2252E-01
+/- ⁿ						2.4192E-05
U-235 wt% ^b		0.0761	0.0852	0.0846	0.0763	
+/- ^b		0.0044	0.0198	0.0068	0.0045	
U-235 g ⁱ		2.4389E-03	1.4268E-03	1.4181E-03	2.4425E-03	
+/- ^j		1.4102E-04	3.3159E-04	1.1399E-04	1.4405E-04	
Segment Total						7.7264E-03
+/- ⁿ						4.0445E-04
U-236 wt% ^b		0.019	0.0126	0.0127	0.0192	
+/- ^b		0.0001	0.0001	0.0001	0.0001	
U-236 g ⁱ		6.0893E-04	2.1101E-04	2.1289E-04	6.1462E-04	
+/- ^j		3.2088E-06	1.6801E-06	1.6773E-06	3.2052E-06	
Segment Total						1.6474E-03
+/- ⁿ						5.1192E-06

Rod "W" 2514716 Calibration

	W-00	W-01	W-02	W-03	W-04	W-05
seg length (in) ^a	3.7	17.498	17.501	17.498	17.504	6.846
total length (in)						8.0547E+01
U-238 wt% ^b		0.2633	1.0224	1.0224	0.2636	
+/- ^b		0.0044	0.0197	0.0067	0.0045	
U-238 g ⁱ		8.4384E-03	1.7122E-02	1.7138E-02	8.4382E-03	
+/- ^j		1.4103E-04	3.3010E-04	1.1240E-04	1.4407E-04	
Segment Total						5.1137E-02
+/- ⁿ						4.0280E-04
tot U ^{c,q}		3.20487	1.6747	1.67628	3.20115	
+/- ^{c,q}		0.00084	0.00107	0.00045	0.00084	

Footnotes

- a. ANL Destructive Chemical Assay of 33-Rod LWBR EOL Sample - Rod W, 2514716, page 4
- b. ANL Destructive Chemical Assay of 33-Rod LWBR EOL Sample - Rod W, 2514716, page 6
- c. ANL Destructive Chemical Assay of 33-Rod LWBR EOL Sample - Rod W, 2514716, page 7
- i. (abundance of the specified isotope)(total weight of uranium) / 100
- j. Error Propagation = $((sd_x/x)^2 + (sd_y/y)^2)^{1/2}(xy)$, where sd is the +/- in the table
- n. Error Propagation = $(\text{SUM}(sd_i^2))^{1/2}$, where sd is the +/- in the table
- q. Uranium values corrected for shear loss

Appendix C
Scrap Storage Liner

ABSTRACT

This appendix provides information about the test fuel contained in the scrap can, or Type D storage liner, in dry storage at the Idaho Nuclear Technology and Engineering Center (INTEC). The test fuel has been through irradiation tests that were conducted as part of the Light Water Breeder Reactor and Advanced Water Breeder Applications programs. Also included are summaries of reports for several of the tests. The fuel was irradiated at several reactors and includes a large variety of fuel compositions. Some of the fuel was sectioned for examination but the majority is intact. A small amount of the fuel is unirradiated. The test material currently stored at INTEC is contained in one fuel handling unit, a scrap storage liner. The intact fuel within this liner is stored in unsealed or sealed containers. The sectioned fuel within this liner is all stored in sealed containers.

CONTENTS

C1.	INTRODUCTION	C-7
C2.	TESTS.....	C-7
C3.	FUEL ROD PROPERTIES.....	C-7
C4.	IRRADIATED TEST REPORT SUMMARIES FOR SELECTED TESTS	C-14
C4.1	Comparison of Dimensional Changes in Fuel Rods with Predictions under Cyclic Conditions of Power and System Pressure	C-14
C4.2	In-Pile Dimensional Changes of Zircaloy-4 Tubing Having Low Hoop Stresses.....	C-15
C4.3	In-Pile Dimensional Changes of ThO ₂ -UO ₂ Fuel Rods with Nonfreestanding Cladding	C-16
C4.4	Fuel Rod-Grid Interaction Wear: In-Reactor Tests	C-17
C4.5	Fission Gas Release From ThO ₂ and ThO ₂ -UO ₂ Fuels	C-19
C4.5.1	Rod Characteristics.....	C-20
C4.5.2	Rod Operating Parameters.....	C-21
C4.5.3	Findings	C-21
C4.6	Irradiation Testing of Internally Pressurized and/or Graphite Coated Zircaloy-4 Clad Fuel Rods in the NRX Reactor	C-22
C4.7	Early-In-Life Performance of Short Rod Duplex Pellet Screening (D-1) Test	C-23
C4.8	Cladding Corrosion and Hydriding in Irradiated Defected Zircaloy Fuel Rods.....	C-27
C4.8.1	Defected Fuel Rod Corrosion and Hydriding.....	C-28
C4.8.2	Experimental Details	C-28
C4.8.3	Postirradiation Examination Results	C-30
C4.8.4	Zircaloy-4 Cladding Hydriding	C-30
C4.8.5	Summary of Corrosion and Hydriding Behavior.....	C-31
C4.8.6	Conclusions	C-31
C4.9	Iodine and Cesium in Oxide Fuel Pellets and Zircaloy-4 Cladding of Irradiated Fuel Rods.....	C-32
C4.10	Corrosion and Hydriding of Irradiated Zircaloy Fuel Rod Cladding	C-33
C4.11	Irradiation Performance of Duplex Fuel Pellet Test Rods Depleted to 9×10^{20} Fissions/cm ³ of Compartment—D-1 Test	C-34
C4.11.1	Fuel Components.....	C-36
C4.11.2	Nonfuel Components.....	C-37
C4.11.3	Test Train Design	C-38

C4.11.4	Nondestructive Examinations.....	C-38
C4.11.5	Destructive Examinations.....	C-41
C4.12	Irradiation Performance of Long Rod Duplex Fuel Pellet Bundle Test—LDR Test	C-44
C4.13	Experimental Results of the Irradiation of Long Rod Duplex Pellet Screening Tests in the NRX Reactor, New Long Duplex Rod (NLDR) Test	C-46
C4.14	In-Pile and Out-of-Pile Corrosion Behavior of Thoria-Urania Pellets	C-47
C4.15	Internal Hydriding in Irradiated Defected Zircaloy Fuel Rods—A Review	C-49
C4.15.1	Pre-LWBR Tests	C-50
C4.15.2	LWBR Tests	C-50
C4.15.3	AWBA Tests	C-51
C5.	REFERENCES	C-52

FIGURES

C-1.	Internal loading arrangement of the scrap canister	C-8
------	--	-----

TABLES

C-1.	Irradiation tests and associated reactor	C-9
C-2.	Physical characteristics of the rods	C-14
C-3.	Environmental and operating characteristics of scrap canister rods	C-14
C-4.	Test name and fuel rod identification numbers.....	C-15
C-5.	Fuel rods for in-pile testing.....	C-16
C-6.	Rods used in wear measurements test.....	C-18
C-7.	Rods used in testing	C-20
C-8.	Percent of fission gas released from rods.....	C-25
C-9.	Expected and measured fuel stack length changes	C-26
C-10.	Rod identification numbers of rods from this test that are in the scrap canister	C-27
C-11.	Rod identification numbers.....	C-27
C-12.	LWBR defected irradiation tests containing fuel rods examined for cladding corrosion and hydriding.....	C-29
C-13.	Rod identification numbers.....	C-32

C-14. Rod identification numbers.....	C-33
C-15. Rod identification numbers.....	C-34
C-16. Compositions in the D-1 rods	C-35
C-17. Density of annular fuel materials.....	C-36
C-18. Properties of tubing for D-1 test rods	C-38
C-19. Preirradiation density and volume change of fuel materials.....	C-41
C-20. Fission product concentrations on and in the cladding	C-43
C-21. Principal design variables	C-46

ACRONYMS

ATR	Advanced Test Reactor
AWBA	Advanced Water Breeder Applications
BOL	beginning of life
CHORT	Corrosion and Hydriding of Reactor Tubing computerized corrosion analysis program
ETR	Engineering Test Reactor
INEEL	Idaho National Engineering and Environmental Laboratory
K_{eff}	The effective multiplication factor is a numerical value indicating how near a particular geometric configuration of nuclear material may be to sustaining a nuclear chain reactor ($K_{\text{eff}} = 1.0$ is a critical mass).
LDR	Long Duplex Rod
LSR	Long Small Rod
LWBR	Light Water Breeder Reactor
NLDR	New Long Duplex Rod
NRX	(Canadian) National Research Experimental (Reactor)
OD	outside diameter
OD/t	outside diameter/thickness (cladding)
PCI	pellet-cladding interaction
PWR	pressurized water reactor
RXA	recrystallization annealed
SP	Special Physics (Tests)
SRA	relief annealed
TD	theoretical density
U^D	depleted uranium
U^E	enriched uranium
U^N	natural uranium
w/o	weight percent

Appendix C

Scrap Storage Liner

C1. INTRODUCTION

Several irradiation tests were conducted as part of the Light Water Breeder Reactor (LWBR) and Advanced Water Breeder Applications (AWBA) programs. Most of the fuel rods used in these tests are contained in one cut fuel storage liner at the Idaho Nuclear Technology and Engineering Center. The cut fuel storage liner is also referred to as the scrap can or the LWBR “Type D” storage liner. The fuel handling unit identification number is engraved on the liner closure head. The can contains: (1) irradiated and unirradiated intact rods, (2) intact rods with intentional defects, (3) intact rod bundles, (4) and rod sections. Some of the rod sections are mounted in epoxy (Clayton 1982, WAPD-TM-1440). The intact rods and rod bundles are contained in 22 unsealed tubes and one special storage compartment within the storage liner in a configuration shown in Figure C-1 (Pruss 1987, WAPD-NRF(L)D-96 as revised by Babyak 1987, WAPD-NRF(L)D-110).

C2. TESTS

Over the course of the research, development, and testing program for the LWBR, 32 tests were conducted. Each test was conducted in a reactor that possessed the test conditions desired. Four different reactors were used. The Advanced Test Reactor (ATR), located at the Idaho National Engineering and Environmental Laboratory (INEEL), offers symmetrical experimental loops that enable a large number of samples to be irradiated at one time. The Engineering Test Reactor (ETR), also located at the INEEL, typically sustained a thermal operating level of 175 megawatts. Test rods were also irradiated at Shippingport Atomic Power Station, which operated two pressurized water reactor (PWR) cores and one LWBR core over the course of the station’s life. The Canadian National Research Experimental (NRX) reactor at the Chalk River Nuclear Laboratory in Chalk River, Ontario, Canada, is owned and operated by Atomic Energy of Canada, Ltd. The reactor is equipped with several test loops that provide pressure, flow, and heat removal systems independent of the reactor for the irradiation of test specimens. The tests and the associated reactors are shown in Table C-1.

C3. FUEL ROD PROPERTIES

The test rods have varying properties. All the test rods had Zircaloy-4 cladding (recrystallization or stress relief annealed), ranging in thickness from 0.018 to 0.039 in. All the rods all also had an X-750 plenum spring, and all were pressurized with helium at beginning-of-life (BOL). Some of the test rods contained U-235, which ranged from about 1.92 to 30 wt% depending on the rod (most were about 93% enriched) and others contained U-233, which ranged from about 5 to 12% wt%. Uranium-233 enrichments were generally either 93.1% or 98.2% (see Table 3A of WAPD-NRF(L)D-5). The length, outer diameter, and other rod properties varied. Specific details about each of the rods can be found in the Fuel Receipt Criteria (WAPD-NRF(L)D-5, WAPD-NRF(L)D-96, WAPD-NRF(L)D-58), or in greater detail in the test reports, outlined below.

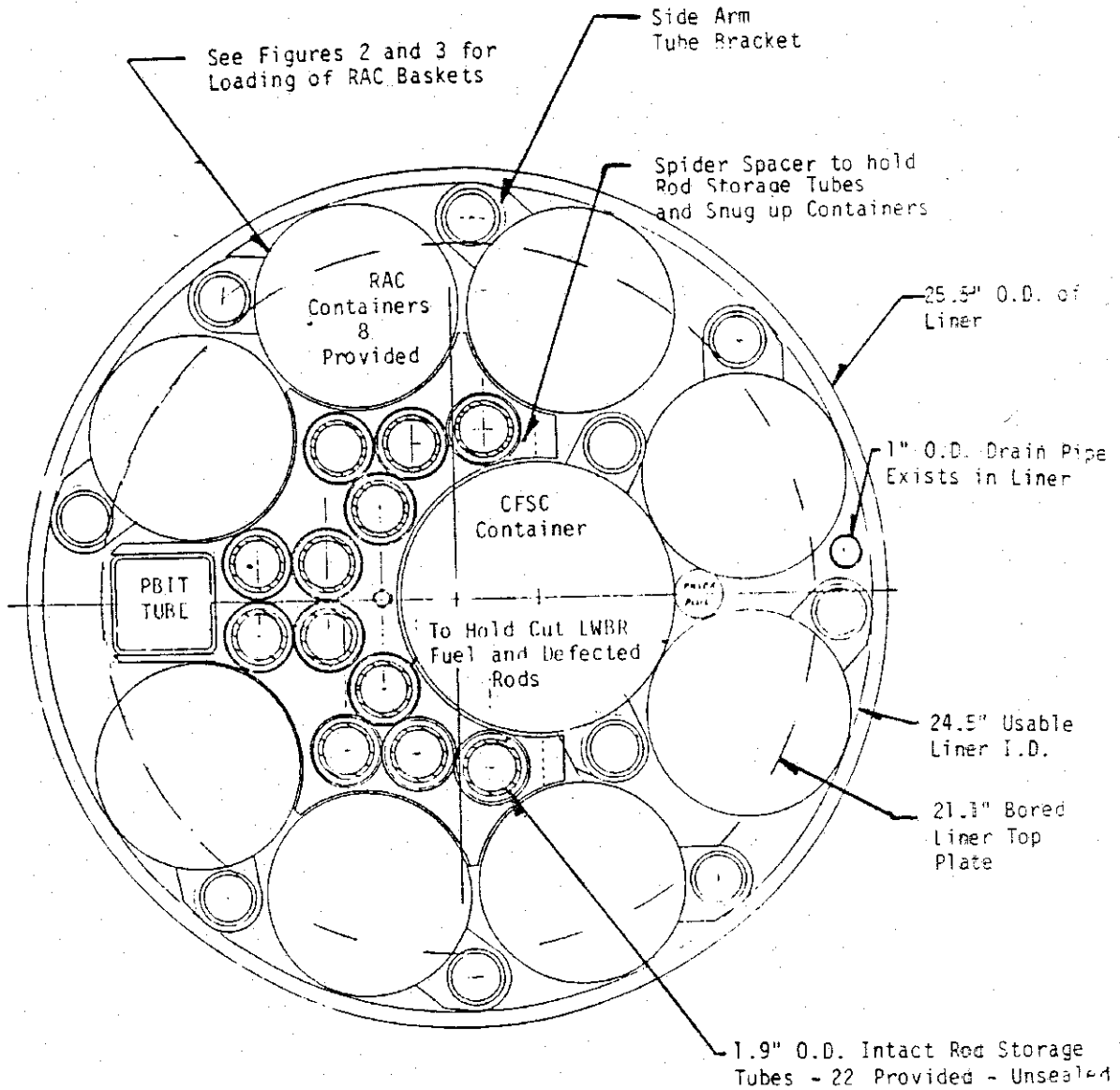

Figure C-1. Internal loading arrangement of the scrap canister.

Table C-1. Irradiation tests and associated reactor (Pruss 1987, WAPD-NRF(L)D-96 as revised by Babyak 1987, WAPD-NRF(L)D-110).

Test Identifier	Description	Reactor
ACT-LPR	Advanced concept test, long pressurized rods	NRX
ALT1	Alternate short rod screening test	ATR
ALT2	Alternate short rod screening test	ATR
B1	Blanket rod screening test	ETR
B1R	Blanket rod screening test	ETR
B1M	Blanket rod screening test	ETR
B3	Six-rod assembly test	ETR
B3A	Six-rod assembly test	ETR
BBT	Blanket bundle test	ETR
C7-LSBR	Large seed blanket reactor development	ETR
D1	Duplex short rod Screening test	ATR
GRIP-I	Grid rod in-pile test	ETR
GRIP-II	Grid rod in-pile test	ETR
GRIP-IIIA	Grid rod in-pile test	ETR
GRIP-IIIB	Grid rod in-pile test	ETR
GRIP-IIIC	Grid rod in-pile test	ETR and ATR
LBR	Long blanket rod test	NRX
LDR	Long duplex rod screening test	ETR
LSR	Long seed rod test	ETR
L12-LSBR	Large seed blanket reactor development	ETR
M13-S2	Seed rod screening test	ETR
M13-S2A	Seed rod screening test	ETR
M13-S3	Seed rod screening test	ETR
M13-S5	Seed rod touching test	ETR
NLBR	New long blanket rod test	NRX
NLDR-1	NRX long duplex rod test	NRX
NLDR-2	NRX long duplex rod test	NRX
NLDR-3	NRX long duplex rod test	NRX
NLDR-4	NRX long duplex rod test	NRX
NLSR	New long seed rod test	NRX
PBIT	Prebreeder bundle irradiation test	ATR
SABRE	Special assembly blanket rod elements	PWR C-1 S-4
SPIRE	Seed prototype irradiation rod experiment	ETR
SWLD	Blanket swing-load test	ETR
TIPPETT II	Thoria performance test	ETR
SIDR	Short intentionally defected rod test	NRX
PM	Power monitor-instrumented alloy rod	
SP	Special physics tests	

C4. IRRADIATED TEST REPORT SUMMARIES FOR SELECTED TESTS

C4.1 Comparison of Dimensional Changes in Fuel Rods with Predictions under Cyclic Conditions of Power and System Pressure (Duncombe and Goldberg 1970, WAPD-TM-940)

Duncombe and Goldberg describe various additions for calculating ratcheting effects to CYGRO model; the effects include fuel cracking, clad collapse, friction between fuel and clad, clad anisotropy, and effects of neutron flux on clad creep. Physical, environmental, and operating characteristics of eight test rods are used to confirm the model. Three of the test rods (79-427, 79-430, and 79-468) are contained in the scrap canister. Physical characteristics of these rods are provided in Table C-2.

Table C-2. Physical characteristics of the rods.

Rod No.	Clad OD (in.)	Clad Thickness (mil)	Clad Type ^a	Fuel-Clad Diametric Gap (mil)	Fuel ^b	Fuel Density (% of theoretical)	Fuel Stack Length (in.)
79-427	0.600	24	SRA	4	ThO ₂ +1.98 w/o U ^E O ₂	98	29.8
79-430	0.600	24	RXA	10	ThO ₂ +1.98 w/o U ^E O ₂	98	29.8
79-468	0.600	24	SRA	11	ThO ₂ +3.42 w/o U ^E O ₂	98	84

a. Zircaloy-4 cladding, tube reduced, nominally 70% cold worked. SRA designates a stress relief at 950°F for 4 hours. RXA designates a recrystallization anneal at 1250°F for 4 hours.

b. Pressed and sintered pellets of length to diameter ratio between 1 and 2, with a 13-mil end-dish of 1.6 in. spherical radius.

Environmental and operating characteristics of scrap canister rods are given in Table C-3.

Table C-3. Environmental and operating characteristics of scrap canister rods.

Rod No.	Peak Heat Flux (10 ³ Btu/hr-ft ²)	Peak Fuel Temp. (°F) ^a	Peak Fast Flux >1 Mev (10 ¹⁴ n/cm ² -s)	Peak Depletion ^b (10 ²⁰ f/cc)	No. of Depressurizations (10 f/cc)
79-427	305	3075	1.21	0.37	2
79-430	301	3000	0.61	0.78	7
79-468	375	4525	0.15	1.94	15

a. Temperatures calculated using a computer program.

b. Calculated peak depletion at time of most recent examinations.

The results of the testing are as follows:

1. Mechanisms important to ratcheting were incorporated into the CYGRO model.
2. The observed progressive length increase of fuel rods having nonfreestanding clad compared satisfactorily with the model.
3. When gross axial wrinkling is observed, the model is less exact; this may be expected because the size and nature of the fuel-clad contact forces are inherently less well known.
4. The choice of parameters that lead to correct axial elongation prediction often do not lead to good prediction of diameter shrinkage; this is believed to be associated with observed clad nonuniformity, such as ridging, ovalness and wrinkling, which invalidate the model to an extent depending on their severity.
5. Further progress may result from improved analysis of axial and circumferential nonuniformity, more accurate representation of clad collapse characteristics, and improved knowledge of the in-pile creep properties of fuel and clad.

C4.2 In-Pile Dimensional Changes of Zircaloy-4 Tubing Having Low Hoop Stresses (Daniel 1970, WAPD-TM-973)

Short screening rods were irradiated in the M13 test loop of the ETR. The Long Small Rod (LSR) full-length rods were irradiated in the E25 test loop of the Canadian NRX reactor. The test identifier and the fuel rods used are given in Table C-4.

Table C-4. Test name and fuel rod identification numbers.

Test	No. of Rods	No. Rods in Scrap Canister	IDs of Rods
M13-S2	14	7	79-316, 79-317, 79-319, 79-322D, 79-399, 79-400, and 79-401
M13-S2A	11	9	79-377, 79-378, 79-379, 79-381, 79-383, 79-385, 79-386, 79-390, and 79-394
M13-S3	14	7	79-332, 79-337, 79-340, 79-435, 79-436, 79-437, and 79-438
M13-S3A	10	3	79-485, 79-491, and 79-493
M13-S4	7	0	0
LSR	6	3	79-432, 79-433D, and 79-434

Several of the test rods were intentionally defected before irradiation by drilling a 5-mil-diameter hole through the cladding after preirradiation corrosion testing. These rods are identified by the letter “D” following the rod number. Summary irradiation histories of the fuel rods are given by Daniel (1970).

The results of the testing are as follows:

- Comparison of length and diameter changes indicates that the diametric shrinkage of the short 0.25-in. OD rods were due entirely to the external pressure, reaching a maximum of about 1-mil (0.4%) at 17×10^{20} fast nvt.

- Diametric shrinkage in the bottom and middle regions of the long 0.25-in. OD rods was influenced by axial tensile stresses, imposed on the cladding by the fuel. This fuel-clad interaction increased the generalized stress over that imposed by the external pressure. Near 2×10^{20} fast nvt, shrinkage was about 6 mil (0.2%) in the absence of fuel-clad interactions but increased to about 2 mil (0.8%) in the presence of such interactions. A model using a modified version of CYGRO was proposed for simulating the performance of these rods.
- The component of the length increase caused by zircaloy growth was about 0.075% at 17×10^{20} fast nvt.

C4.3 In-Pile Dimensional Changes of ThO₂-UO₂ Fuel Rods with Nonfreestanding Cladding (Giovengo 1970, WAPD-TM-986)

Axial ratcheting is the progressive extension or elongation of fuel rods in-pile under cyclic conditions of power and system pressure resulting from irradiation. Axial ratcheting is made up of three components: (1) stress-free zircaloy growth, (2) diameter shrinkage due to system pressure, and (3) fuel-clad interaction. Data were presented for three series of irradiation testing of fuel rods with nonfreestanding cladding: the C7, NRX, and B1 series of tests. A physical description of the fuel rods along with a summary of the operational and measurement data is given. Rods used in this test are identified in Table C-5.

Table C-5. Fuel rods for in-pile testing.

Test	No. of Rods	No. of Rods in the Scrap Canister	Rod Identification Numbers
C7-B3	5	5	79-299, 79-300, 79-302, 79-304 and 79-308
C7-B3A	9	9	79-349, 79-350, 79-352, 79-353, 79-356, 79-374, 79-375, 79-376 and 79-405
NRX	6	3	79-310, 79-467, 79-468, 79-495, 79-575 and 79-576
B1	4	2	79-427, 79-428, 79-429 and 79-430
B1RA	1	1	79-577
B1RB	2	2	79-572, 79-579 and 79-581, 79-586

The results of the testing are as follows:

- Annealed cladding and low fast-flux environment resulted in the maximum amount of elongation.
- Cold-worked cladding and low fast-flux environment resulted in the least amount of elongation.
- Both cold-worked and annealed cladding resulted in elongation in the midrange of the data.
- Flat-ended pellets resulted in substantially greater elongation than dished-end pellets.
- For flat-ended pellets high center temperature (>2500°F) resulted in elongation 2–3 times greater than rods operated at lower temperature (<2000°F).

- Fuel clad diametric gap and clad diameter-to-thickness ratio had a significant but less pronounced effect on ratcheting.
- Accelerated power cycling and fuel loading had no observed effect on ratcheting.
- Pressure cycling appears to be the predominant mechanism inducing elongation from fuel-clad interaction; a correlation could not be determined between the number of pressure cycles or cladding texture and the extent of ratcheting.

C4.4 Fuel Rod-Grid Interaction Wear: In-Reactor Tests (Stackhouse 1979, WAPD-TM-1347)

Wear of the zircaloy cladding of LWBR irradiation test fuel rods, resulting from relative motion between rod and rod support contacts, is reported. Measured wear depths were small, 0.0–2.7 mils, but are important in fuel element behavior assessment because of the local loss of cladding thickness as well as the effect on grid spring forces that laterally restrain the rods. An empirical wear analysis model, based on out-of-pile tests, is presented. The model was used to calculate the wear on the irradiation test fuel rods attributed to a combination of up-and-down motions resulting from power and pressure/temperature cycling of the test reactor, flow-induced vibrations, and assembly handling scratches. The calculated depths are generally deeper than the measured depths.

The LWBR core employs ordered arrays of long (10 ft), small diameter (0.3–0.8 in.), zircaloy clad, cylindrical fuel elements. The fuel rods are supported axially by threaded end connectors on the rods attached to either the top or the bottom base plate of a module assembly. Each rod is thus fixed at one end and free at the other end. Lateral support for the rods is provided by a series of supports, called grids, at several axial locations along the length of the rods. Each grid contains, for each rod, a hexagonal-shaped cell with a spring and opposing fixed reaction dimples set at 120 degrees circumferentially from the spring. The spring applies lateral force on the fuel rod in the cell to hold it firmly against the dimples, while allowing relative axial movement between the rod and grid support points during reactor operation. Interaction between the fuel rod and the supporting springs and dimples caused by fuel rod length changes and vibration can result in wear on the zircaloy cladding of the fuel rods. Wear of the AM-350 stainless steel grid contact points has been found by test experience to be negligible relative to the fuel rod cladding wear.

Cladding wear may be caused by the combined effects of three types of interaction between fuel rods and support grids: (1) handling scratches, often along the full rod length, that occur when fuel rods are initially pulled into the grid supports; (2) axial motion of the rod relative to the grid supports due to fuel rod axial expansion and contraction during reactor power cycles and pressure/temperature cycles; and (3) flow-induced vibratory wear.

Cladding wear is of concern (1) because the thinning of the cladding increases stresses in the thinned section with a consequent reduction in margin-to-failure stress limits, and (2) because of its contribution to a reduction in the grid spring fuel rod support force with potential for reduced rod-to-rod and rod-to-structure clearances. In addition, a complete loss of grid contact force may result in excessive fuel rod vibration, creating a potential wear/fretting condition, as demonstrated in out-of-pile wear tests.

Stackhouse presents fuel rod cladding wear data obtained from in-reactor rod bundles tested in the LWBR fuel element development program and compares these data to wear estimates predicted using a model developed from out-of-pile wear tests. The LWBR fuel rods were composed of high density ThO₂-UO₂ and ThO₂ fuel pellets contained within Zircaloy-4 tubes having outside diameters of about

0.30 or 0.57 in., and lengths of about 8 ft. The rods were precorrosion filmed before insertion into the grid supports prior to irradiation.

Wear measurements were obtained on 34 fuel rods; all but one of the fuel rods are in the scrap liner. The rods were supported laterally by AM-350 stainless steel grids using of hexagonal-shaped grid cells that contain a spring and two dimples, or two pairs of dimples, set at 120 degrees circumferential from each other. Altogether 1298 support contact points are represented by the 34 fuel rods examined. (The number of support contact points for each rod was determined by multiplying the number of spring and dimple reaction points at each grid level by the number of grid levels supporting the rod. Multiple sets of wear marks on several rods are also included in the total.) Only 176 contact points were directly measured. The remaining 1122 support contact points were not measured because they were undetectable or obviously shallow; these are assumed to have wear depths of 0.0-0.5 mils. Ninety-five percent of the wear spot depths are 1.0 mil or less, 4 % are 1.1–2.0 mils, and 1% are 2.1–2.7 mils deep.

During examination of the irradiated fuel rods, wear depths were measured at the free end grid levels and at other levels where visual examination indicated that significant cladding wear had occurred. Other cladding wear spots that appeared to be smaller than 0.5 mil in depth were usually not measured. For all but six of the 34 rods, maximum rod wear occurred at the free-end grid support location. The occurrence of maximum wear at the rod free ends is attributed to the fact that this location is where the longest rod axial movement relative to grids occurs during power and pressure/temperature cycling, with resulting higher reciprocating wear. Flow-induced vibration wear also is expected to be a maximum at the free end of top mounted rods because of rod excitation by coolant flow impingement on the ends of the rods.

Wear mark depth was measured nondestructively with a profilometer considered to have an accuracy of ± 0.2 mils. In addition, destructive examination of wear depth was performed metallographically on some rods by polishing transverse rod sections through the wear mark in successive planes about 20–30 mils apart. Photomicrographs taken at each plane were measured to obtain wear depth. The profilometry measurements agreed well with metallographic measurements.

All wear measurements and their location with respect to individual grids and to grid springs and dimple reaction points, are given by Stackhouse. Also given are test reactor exposure times, numbers of actual power and pressure/temperature cycles, stroke lengths, and measured overall rod length increases. The rod identification numbers are given in Table C-6 for 33 of the rods in the scrap canister that were used for the wear measurements tests.

Table C-6. Rods used in wear measurements test.

79-610	79-621	79-630	79-440	79-444	79-455	79-509	79-517
79-613	79-622	79-631	79-441D	79-445	79-459	79-513	79-522
79-614D	79-623	79-632	79-442	79-449	79-502	79-514	79-524
79-617	79-624	79-439	79-443D	79-450	79-504D	79-516	79-572
79-619	79-586						

The conclusions drawn from the testing are as follows:

- Maximum measured wear depth on the irradiation-tested fuel rods supported in grids having geometry similar to the LWBR design was 2.7 mils and was located at the free-end grid support of a top-mounted fuel rod.

- Fuel rod wear was deepest at the rod free-end grid support on 28 of 34 rods.
- Top mounted rods had greater wear depth at the free-end grid support than bottom mounted rods. This condition is attributed to greater vibratory wear experienced by the top mounted rods due to impingement of the coolant flow on the bottom free-ends of these rods.
- Wear depth on fuel rods that accumulated a high number of EFPH or power and pressure/temperature cycles was not significantly greater than that on rods with shorter test lives. This behavior is in accordance with the basis for the wear analysis model and is a result of rod axial growth during reactor operation.
- Maximum-measured-wear depths were generally less than the total amount of wear predicted by a wear analysis model developed from out-of-pile reciprocating wear tests. The predicted values included reciprocating wear, plus an allowance for vibratory wear and assembly and handling scratches.
- A high proportion, about 95%, of the rod-grid contact points examined had low wear of less than one mil depth.
- High wear is sometimes found at contact points associated with off-nominal conditions such as high rod bowing or contacts between the rod and grid at other than the spring and dimples.

C4.5 Fission Gas Release From ThO₂ and ThO₂-UO₂ Fuels (Goldberg et al. 1982, WAPD-TM-1350)

Fission gas release data are presented from 51 fuel rods irradiated as part of the LWBR irradiation test program (23 of these fuel rods are contained in the scrap canister). The fuel rods were Zircaloy-4 clad and contained ThO₂ or ThO₂-UO₂ fuel pellets, with UO₂ compositions ranging from 2.0–24.7 w/o and fuel densities ranging from 77.8–98.7% of theoretical. Rod diameters ranged from 0.25–0.71 in. and fuel active lengths ranged from 3–84 in. Peak linear power outputs ranged from 2–22 kW/ft for peak fuel burnups up to 56,000 MWD/MTM. Measured fission gas release was quite low ranging from 0.1–5.2%. Fission gas release was higher at higher temperature and burnup and was lower at higher initial fuel density. No sensitivity to UO₂ composition was evidenced. A calculation model is described that includes terms to represent fission gas release as a function of temperature, using a diffusion model, and as a function of density to account for release due to knockout and recoil at free surfaces. The model is developed on both a best estimate and bounding basis.

The amount of fission gases released from oxide fuel pellets during irradiation in power reactors is important to reactor design primarily in two design areas. First, release of fission gases from the fuel to the internal rod compartment results in an increase in rod internal pressure with increasing burnup. The higher internal pressure increases proximity to material property limits for a postulated loss of coolant accident, during which fuel rod cladding can potentially experience high temperatures, resulting in loss of strength and more susceptibility to swelling and rupture. Second, because fission gases (primarily xenon and krypton) have much lower thermal conductivity than the initial fill gas (typically helium or argon) used in light water reactor fuel rods, more fission gas release can result in higher operating fuel temperatures due to the degraded heat transfer in the fuel-cladding gap.

The report contains (1) data on fission gas release from ThO₂ or ThO₂-UO₂ fuels obtained from 51 fuel rods from the LWBR test program, and (2) comparisons of the measurements to a calculation model used in performance assessments. Dimensional, material characteristics, and environmental history

of the test fuel rods are described. The fission gas release measurements are given along with a description of the measurement procedures and an assessment of measurement uncertainty. The calculation model is described, and the results of application of the model are compared to the measurements.

Measured fission gas release (measurement uncertainty of plus or minus 8% of nominal) was generally low, ranging from <0.1–5.2% of the fission gases theoretically produced by fissioning. Gas release was predominantly below 2% for high-density (95% theoretical or greater) fuels. Fission gas release was higher at higher temperatures, higher burnup, and lower density. No sensitivity to UO₂ composition was observed.

A calculation model was presented that includes terms to represent fission gas release at both high temperatures (assuming a gas bubble diffusion model) and low temperatures (based on a recoil plus knockout mechanism). The high temperature term accounts for migrating gas bubbles that are released from the fuel due to intersection with a surface (e.g., cracks or open pores). Depending on specific fuel properties and burnup, critical temperatures for release of bubbles from dislocations and grain boundaries are calculated.

The low temperature term is adapted from a model that assumes that fission gas is released by recoil and knockout at free surfaces. Pellet density initially serves as a measure of free surface area, which increases with burnup (presumably due to fuel cracking). The model is developed on both a best estimate and bounding basis.

Gas release for long rods, which experience nonuniform power profiles, is calculated in several axial segments (using average power generation for each segment) and integrated along rod length. The best-estimate model fits through the middle of the scattered data. All data are conservatively bounded by the bounding model.

C4.5.1 Rod Characteristics

Test fuel rods from the LWBR development program were Zircaloy-4 clad, nonpressurized (one atmosphere of helium, initial fill) and contained ThO₂ or ThO₂-UO₂ fuel pellets. Rod characteristics are summarized in the report for the 51 rods for which fission gas release data was obtained (23 of the fuel rods are contained in the scrap canister). The fuel rods are grouped by fuel type (100% ThO₂, ThO₂ + ²³³UO₂ and ThO₂ + ²³⁵UO₂). The identification numbers of the 23 rods contained in the scrap canister are given in Table C-7. (In the scrap canister there are no 100% ThO₂, three ThO₂ + ²³³UO₂ [the first three below], and the rest are ThO₂ + ²³⁵UO₂ fuel rods).

Table C-7. Rods used in testing.

79-442	79-509	79-570	79-576	79-613	79-632
79-445	79-513	79-572	79-605	79-617	79-656
79-449	79-514	79-573	79-608	79-623	79-671
79-349	79-522	79-575	79-610	79-631	

Fuel characteristics given for each rod are composition, pellet density, pellet dimensions, and in-core fuel pellet stack length. Fuel compositions ranged from pure thoria to about 25 w/o UO₂. Fuel densities were generally 95–98% theoretical oxide density (10.0 g/cc-ThO₂ and 10.24 g/cc-ThO₂ + 25 w/o UO₂). Nominal fuel pellet dimensions are given, including end-face geometry (flat or dished, with

4–22 mil dish depth). Fuel pellet diameters were 0.21–0.65 in., with length/diameter ratios of 1.0–3.0. In-core fuel pellet stack length ranged from about 3–7 in. in short rods and from 30–84 in. in long rods.

Cladding heat treatment (RXA-recrystallization anneal or SRA-stress relief anneal), outside diameter, and diameter to wall thickness ratio are given for each rod. Rod diameters ranged from about 0.25–0.71 in., with cladding OD/t ratios of 12–25. As-fabricated fuel-cladding diametric gaps were 2–10 mils. Fuel-cladding diametric gaps (no direct contact) are a source of thermal impedance and lead to higher fuel temperatures and greater gas release. Cladding OD/t and heat treatment affect the rate of creep down of the cladding diameter (under external pressure) and thereby the fuel-cladding diametric gap and gas release.

C4.5.2 Rod Operating Parameters

The test rods for the fission gas tests were irradiated in three different test reactors: (1) the ETR, (2) the ATR, and (3) the NRX. In-pile operating times ranged from <1000 to ~20,000 hours under nominal coolant conditions of 2000 psi and 550°F. Individual rod operating parameters are summarized in the report.

Peak and average axial linear power and fuel burnup are reported for each rod. Axial average values are equal to peak values for short rods, but are about 0.6–0.9 times the peak values for long rods. Peak linear power of most rods ranged from 2–15 kW/ft; 4 of the 51 rods were higher than 15 kW/ft up to a maximum of 22 kW/ft. Peak burnup ranged from about 1,000–56,000 MWD/MTM.

Peak values (axial position and operating history) of fuel temperatures at the rod centerline and pellet surface were calculated using the CYGRO (Newman, Giovengo, and Comden 1977)/FIGRO (Goldberg 1969, WAPD-TM-757) computer programs. (Time averaged temperatures are about 80% of peak temperatures.) Centerline fuel temperatures at the peak axial power locations ranged from <2000 to over 4000°F and fuel pellet surface temperatures ranged from about 800–1800°F. These temperatures are low relative to the thorium-based oxide melting temperatures (about 5900°F) so that no significant fuel redistributions due to pellet coring or melting were expected.

The ThO₂ dislocation release temperature (for release of gas bubbles from dislocations) was also calculated for each rod, assuming peak conditions and using the model by Warner (1969) WAPD-TM-805. This temperature provides a measure of fractional fuel pellet volume for intermediate-high-temperature fission gas release. The ThO₂ dislocation release temperatures range from about 2630–2930°F.

C4.5.3 Findings

The conclusions drawn from the testing within the range of parameters tested for 51 fuel rods are as follows:

- Fission gas release is greater at higher fuel temperatures and burnups. These effects can be satisfactorily predicted by a model that accounts for gas bubble-coalescence, release from grain boundaries, and dislocations.
- Higher initial fuel density results in significantly less fission gas release. This effect can be satisfactorily predicted by a model that accounts for release due to recoil and knockout of gas bubbles at free surfaces.
- No sensitivity to UO₂ composition or rod diameter was observed.

Additional testing (Goldberg et al. 1979, WAPD-TM-1350ADD) was conducted on three fuel rods (79-349, 79-375, and 79-405). All three rods are contained in the scrap canister; 79-349 was included in the first gas testing. These rods experienced relatively high-constant-peak power (18–22 kW/ft). The data indicate that at these high powers (and thus high fuel temperatures), ThO₂-UO₂, 92-95% of theoretical density, experiences equiaxed grain growth and relatively high fission gas release (up to 15%). These data supplement the data on the 51 fuel rods from above, which indicated low fission gas release (from 0.1–5.2%) for operation predominately below 14 kW/ft.

C4.6 Irradiation Testing of Internally Pressurized and/or Graphite Coated Zircaloy-4 Clad Fuel Rods in the NRX Reactor (from Hoffman and Sherman 1978, WAPD-TM-1376)

Alternate fuel rod design concepts were explored to improve performance capability for commercial scale light water prebreeder cores to efficiently produce ²³³U from thorium. The initial screening tests used three fuel rods and two previously tested rods. The three rods (79-584, 79-706, and 79-707) were assembled from spare components previously fabricated for an LWBR blanket irradiation test to provide a basis for comparison with two previously irradiated, noncoated, nonpressurized rods, one of which was intentionally defected (79-583D and 79-587). All five rods are contained in the scrap liner. The rod identification and basic feature of the rods follows:

- Prepressurized with helium to 500 psi at room temperature
- Graphite barrier coating on the cladding inside surface
- Combined prepressurization and graphite coating
- Previously irradiated, noncoated, nonpressurized rod, and intentionally defected (79-583D)
- Previously irradiated, noncoated, and nonpressurized rod.

The helium pressurization, which is standard commercial practice, prevents collapse into unsupported gaps, delays fuel-cladding interaction due to reduced cladding pressure differential and mitigates the reduction of the thermal conductivity of the gas mixture in the fuel-cladding gap with depletion. The graphite coating provides lubrication of the fuel-cladding interface, thereby reducing fuel-cladding interaction, and may provide a barrier to fission product stress corrosion attack of the cladding. The tests of pressurized rods were directed at investigation of fuel rod performance, and were not focused on thermal-hydraulic considerations.

The fuel was ThO₂-3.06 w/o UO₂ at a density of 95–98% of theoretical density. The fuel stack contained 84 in. of ThO₂-UO₂ pellets with thorium pellets above and below the ThO₂-UO₂ fuel stack. A 10-in. plenum incorporating a Fe-Ni-Cr alloy hold-down spring was present at the top of the stack.

The three test rods (79-584, 79-706, and 79-707) were irradiated, one rod at a time, in the NRX reactor. The coolant was 2000-psi water at an average temperature of 560°F with a pH of 10.1–10.3 maintained by NH₄OH. Flow velocity was 19.6 ft/s. Each rod was irradiated for about 100 full power days at peak linear power output of 13–14 kW/ft. Power was then increased by 30% to 17–18 kW/ft to simulate the increased power in an up-power maneuver. The power was maintained at the 30% higher level for about 40 full power days, and the rods reached a peak depletion of 1.5×10^{20} f/cc (5800 MWD/MT) and a peak, fast fluence (>1 Mev) of 1.9×10 n/cm². Rods 79-583D and 79-587 experienced similar histories except that 79-583D, the intentionally defected rod, did not experience the

up-power maneuver. All rods were periodically removed from testing during reactor shutdowns and examined at Chalk River; these measurements included both rod length and diameter.

Based on comparisons between the nonpressurized, noncoated rod (79-587) and the prepressurized and graphite coated rod (79-707), initial prepressurization with helium plus graphite coating the inside cladding surface reduce both overall axial cladding strains and peak axial cladding strains. Diameter changes have also been significantly reduced. These reductions are attributed to reduced fuel-cladding interaction and possible enhanced fuel densification due to the relatively higher gas pressure on the fuel pellets. Either prepressurization or graphite coating by itself resulted in an intermediate level of improvement from the nonpressurized, noncoated rod, but these comparisons are not as direct due to differences in fuel-cladding gap size.

C4.7 Early-In-Life Performance of Short Rod Duplex Pellet Screening (D-1) Test (Sphar and Sherman 1979, WAPD-TM-1378)

To support the development of the duplex pellet fuel element, a screening irradiation test was designed, fabricated, and irradiated in the ATR at the Idaho National Engineering Laboratory. The test consisted of 21 rods irradiated in three holders of seven rods each in a single ATR test loop. The length of the rods was restricted to 11 in. to allow a greater number of rods and thus a greater number of variables to be tested. Duplex pellet annuli of three different compositions was included. The seven rods of the first holder contained UO₂ annuli; the second holder contained UO₂-ZrO₂ annuli; and the third contained UO₂-ZrO₂-CaO annuli. Other test parameters were:

- Two levels of rod internal prepressurization (100 and 500 psig at room temperature)
- Two types of zircaloy cladding heat treatment and diameter to thickness ratio (stress relief annealed with OD/t = 16.0 and recrystallized annealed with OD/t = 13.9)
- Thoria spacers of three different thicknesses for separating duplex pellets axially to maintain axial alignment of the annulus and central core (0.05 in., 0.1 in., and 0.5 in.)
- Varying initial diametric clearance gap between the annulus and cladding (45–85 mils) and between the annulus and central pellet (21–102 mils).

The D-1 duplex pellet-screening test used 21 fuel elements (16 are in the scrap canister) 11 in. in length and 0.3 in. in diameter. The rods consisted of top and bottom Zircaloy-4 end-closures welded into seamless Zircaloy-4 cladding. Contained within the cladding was an 8-in. stack of fuel pellets and a 0.785-in. long plenum region containing an Inconel-X hold-down spring. All 21-test rods were irradiated simultaneously for 32.6 days in the ATR at the INEEL. The rods operated at 13–15 kW/ft reaching depletion of $1.2\text{--}1.3 \times 10^{20}$ f/cc averaged over the total duplex pellet volume and $\sim 2.4\text{--}2.6 \times 10^{20}$ f/cc in the annulus. The fast neutron fluence ($E > 1$ Mev) exposure of the rods ranged from $2.8\text{--}3.9 \times 10^{20}$ n/cm². The coolant was water pressurized to 2000 psi at an average temperature of 520°F. Coolant velocity past the rods was 18 ft/s. Following irradiation, the 21 rods were subjected to nondestructive examination. In addition, one rod of each annulus composition type was subjected to destructive examination. Nondestructive examinations consisted of:

- Visual inspections
- Dimensional measurements

- Neutron radiography
- Gamma ray scanning.

Destructive examinations consisted of:

- Collection and analysis of the rod internal atmosphere to determine fission gas release
- Depletion analysis
- Cladding fluence determination
- Metallographic evaluation of fuel components and cladding.

Visual examinations of the rods as removed from the reactor revealed a thin gray layer of crud that was readily removed by wiping with alcohol soaked cloths. Removal of the crud layer revealed lustrous black oxide surfaces not noticeably different from the preirradiation condition. Rod average diameter changes were small, the greatest being a decrease of 0.52 mil. The changes correlated with cladding properties, fast fluence, and rod internal pressure as was expected in the absence of fuel-cladding interaction. Averaged diameter changes for rods in each cladding type-internal pressurization category agreed with calculations to within 0.24 mil.

Rod lengths increased by as much as 0.061% and, as in the case of diameter, correlated with cladding properties, fluence, and rod internal pressure. Predicted length increases by stress-free zircaloy growth, and elongation caused by the diameter change and anisotropy of the cladding material, were larger than the measured changes by factors of 1.5–2.9. However, the length changes were small, and the over-prediction represented only 0.02–0.05% strain.

Neutron radiography revealed no evidence of fuel redistribution and melting. Cracking of the annuli of all three compositions was observed with the maximum degree of cracking noted in the $\text{UO}_2\text{-ZrO}_2$ annuli. Fuel stack lengths in the UO_2 annulus rods and in the $\text{UO}_2\text{-ZrO}_2\text{-CaO}$ annulus rods decreased on the average by 0.22 and 0.40% respectively. The fuel stacks in the $\text{UO}_2\text{-ZrO}_2$ annulus rods showed an average length increase of 0.41%. There is no basis for expecting expansion of the fuel stacks in the $\text{UO}_2\text{-ZrO}_2$ rods, and the length increase is believed to be associated with the significantly greater cracking observed for this fuel material and small separations of fuel pieces.

Gamma scans, performed primarily to determine the axial power shape in the rods, indicated that peak to minimum duplex pellet power in the rods was less than 1.25. This indicates that the differential neutron shrouding employed during irradiation to offset the basic neutron flux profile of the test reactor was effective.

Destructive analysis for depletion and fluence was completed for the UO_2 annulus rod. The measured depletion was 1.27×10^{20} f/cc of compartment (compartment is defined as: the volume inside the cladding per unit length of duplex pellet). The depletion implies a time-averaged rod power level of 14.4 kW/ft, in good agreement with the desired power level. The measured fast neutron fluence experienced by the cladding was 3.9×10^{20} n/cm², which corresponds to a time-averaged neutron flux of 1.4×10^{14} n/cm²-s.

The percentage of fission gas released from the fuel was measured on one rod of each fuel type. Results are presented in Table C-8.

Table C-8. Percent of fission gas released from rods.

Rod Type	Rod ID	Fission Gas Release
UO ₂	97-23	0.06%
UO ₂ -ZrO ₂	97-22	0.21%
UO ₂ -ZrO ₂ -CaO	97-37	0.39%

These low values indicate that the annulus temperatures were below the temperatures at which substantial migration of gas from dislocation and grain boundaries occurs.

Hydrogen concentration in the cladding of all three rods was about 25 ppm, which is consistent with the as-received content plus the expected hydrogen pickup in the preirradiation corrosion test and 32.6 days of in-pile operation. No change in cladding grain size was observed.

Oxide formation on the outside surface of the cladding for all three rods was observed to be 1 micron or less. About 0.5 micron was present in the preirradiation condition based on the rod weight gain during preirradiation corrosion testing. On the clad inside surfaces, oxide formation was irregular, varying from no discernible thickness over most of the surface to isolated patches with maximum thickness of 7 microns. The oxide formation was presumably caused by oxygen, produced during fission and released from the fuel, collecting at the cladding.

Metallographic evaluation of the microstructure of the ThO₂ central pellets and spacers from all three rods indicated little change, if any, from the preirradiation condition. Porosity did not appear to have changed during irradiation. Grain size after irradiation varied in the range ASTM 6-10 (13–50 microns) compared to a preirradiation size range of ASTM 5-11 (9–70 microns) with no evidence of equiaxed or columnar grain growth.

Comparison of pre- and postirradiation annulus porosity was made by means of a Quantimet Television Microscope analysis of pore volume. For the UO₂ rod, total porosity volume in the annulus decreased to about 70% of the preirradiation value near the outer surface and to 40–50% in the inner regions. The average diameter of the remaining pores was not appreciably different from the average preirradiation pore diameter. The postirradiation grain size (12 microns average) was uniform and there was no evidence of change in grain size with irradiation. The porosity in the irradiated fuel was observed to be located primarily at the grain boundaries whereas both intra-granular and inter-granular pores existed in the preirradiation condition.

In the UO₂-ZrO₂-CaO annulus rod, Quantimet analysis showed an overall porosity decrease to about one-third of the preirradiation value, essentially equal to the decrease observed in the UO₂ annulus. The porosity change was not uniform across the annulus wall thickness; it varied from a decrease to one-half at the outside surface to one-fifth near the inside surface. The grain in the UO₂-ZrO₂-CaO fuel in the postirradiation condition was ~40 microns (on the average), and there was no evidence of grain growth.

In the UO₂-ZrO₂ annulus rod, the preirradiation porosity was uniform across the annulus thickness but the pore size was significantly larger than the pore sizes in the UO₂ and UO₂-ZrO₂-CaO fuels. After irradiation, porosity appears to have been essentially eliminated. In addition, the lateral surfaces of the UO₂-ZrO₂ annulus show an irregular shape distinctly different from the other annulus materials. This may be due to nonuniform shrinkage associated with the greater UO₂-ZrO₂ densification and lower in-pile creep strength as compared to the UO₂ and UO₂-ZrO₂-CaO fuels. The average preirradiation grain size of the UO₂-ZrO₂ material was about 11 microns. After irradiation, etching of the

fuel failed to reveal grain structure. The lack of UO₂-ZrO₂ post-irradiation grain structure is consistent with prior experience and may be associated with the phase transformation.

Based on the densification implied by the Quantimet analysis of metallographic samples, and the assumed isotropic volume change and fuel swelling component of 0.7-percent $\Delta v/v$ per 10 f/cc, expected fuel stack length changes were derived and compared to the measured length changes with results as given in Table C-9.

Table C-9. Expected and measured fuel stack length changes.

Fuel Stack Length Change			
Rod Type	Rod ID	Derived from Densification Measurements	Measured from Neutron Radiographs
UO ₂	97-23	-0.5	-0.22
UO ₂ -ZrO ₂	97-22	-1.7	+0.41
UO ₂ -ZrO ₂ -CaO	97-37	-0.7	-0.40

For the UO₂ and UO₂-ZrO₂-CaO rods, the measured stack shrinkage is 0.3% less than that implied by the net effect of densification and swelling. For the UO₂-ZrO₂ rods, the discrepancy is 2.1%. However, the measurements from the radiographs include the effects of annulus cracks and associated small separations. The large discrepancy for the UO₂-ZrO₂ fuel is probably because it was more extensively cracked than the other fuels.

In summary, examination of the 21 rods of the D-1 test after irradiation at 13–15 kW/ft for 32.6 days to peak depletions of $1.2\text{--}1.3 \times 10^{20}$ f/cc and fast neutron fluences of $2.8\text{--}3.9 \times 10^{20}$ n/cm² revealed no deficiencies in the early-in-life performance of rods with duplex pellets. The UO₂-ZrO₂ annuli duplex pellets had greater densification than the other two fuel types; however, this did not result in detrimental performance such as excessive operating temperatures or enhanced fission gas release.

The rod identification numbers of the 16 rods of this test contained in the scrap canister are given in Table C-10.

Table C-10. Rod identification numbers of rods from this test that are in the scrap canister.

97-1	97-19	97-23	97-36D
97-12	97-20	97-25	97-37
97-16	97-21	97-31	97-40
97-16	97-22	97-34	97-42

C4.8 Cladding Corrosion and Hydriding in Irradiated Defected Zircaloy Fuel Rods (Clayton 1985, WAPD-TM-1393)

Twenty-one LWBR irradiation test rods containing ThO₂-UO₂ fuel and zircaloy cladding with holes or cracks operated successfully. Zircaloy cladding corrosion on the inside and outside diameter surfaces and hydrogen pickup in the cladding were measured. The observed outer surface zircaloy cladding corrosion oxide thickness of the test rods were similar to thickness measured for nondefected irradiation test rods. An analysis model, which was developed to calculate outer surface oxide thickness of nondefected rods, gave results that were in reasonable agreement with the outer surface oxide thickness of defected rods. When the analysis procedure was modified to account for additional corrosion proportional to fission rate and to time, the calculated values agreed well with measured inner-oxide corrosion film values. Hydrogen pickup in the defected rods was not directly proportional to local corrosion oxide weight gain as was the case for nondefected rods.

The rod identification numbers of the rods in the scrap canister are given in Table C-11.

Table C-11. Rod identification numbers.

79-301D	79-353	79-504D	79-609D
79-307D	79-441D	79-583D	79-614D
79-322D	79-433D	79-587	

Note: Rods 79-353 and 79-587 defected in-service

Nuclear power reactors are designed, manufactured, and operated to avoid conditions known to cause in-pile fuel rod cladding defects. Stringent controls on manufacturing and inspection minimize the probability of cladding fabrication defects. However, defected fuel rods (i.e., where the cladding has a through-thickness hole or crack) have occasionally occurred in both test reactors and commercial power reactors. In the event of a cladding defect, coolant can enter the rod interior and hence the cladding internal surface is subject to oxide corrosion and hydrogen pickup. Most defected zircaloy fuel rods operated satisfactorily until removal during a normal refueling. However, under certain conditions zircaloy cladding may be degraded over time and pose a threat to continued operation. Therefore, the operational behavior of defected fuel rods is an important engineering consideration for a reactor core.

The report summarizes the cladding corrosion and hydriding results of the LWBR irradiation test program on defected ThO₂-UO₂- fueled Zircaloy-4 clad rods. Two major consequences of defected rod operation, internal surface cladding corrosion and cladding hydrogen pickup, were examined to determine if defected fuel rod corrosion rates and hydrogen pickup behave similarly to those of nondefected Zircaloy-4 rods; the nondefected rods are exposed to coolant on their outer diameter surfaces only. Cladding corrosion film thickness and hydrogen content measurement on intentionally defected Zircaloy-clad fuel rods from the LWBR irradiation test program are compared with values calculated by a computerized corrosion analysis procedure designated as CHORT (Corrosion and Hydriding of Reactor Tubing). The CHORT procedure was based on corrosion and hydriding data from nondefected irradiation test rods with only the outer cladding surface exposed to coolant. Predictions of corrosion oxide thickness are in reasonable agreement with measured data. However, hydrogen pickup in defected fuel rods was observed to behave differently than in nondefected rods. Unexpectedly high hydrogen concentration in cladding at low power segments of certain defected Zircaloy-4 fuel rods was observed and is attributed to gaseous hydrogen transport along the fuel rod cladding gap.

C4.8.1 Defected Fuel Rod Corrosion and Hydriding

A defect is defined as a breach of cladding integrity, i.e., a perforation, slit, or pinhole, that usually leaks fission products to the coolant and coolant to the rod internals. A defected zircaloy-clad fuel rod experiences greater cladding corrosion and hydriding than a normal nondefected rod because both inside and outside cladding surfaces are exposed to coolant. The amount of corrosion and hydriding on the outside surface of a defected fuel rod should be about the same as on a nondefected rod because the conditions are the same. If a defect occurs in the cladding, coolant may enter the fuel rod and reach high temperature when the core is taken to power. Corrosion and hydriding on the inside surface of the cladding will then occur at a faster rate than on the outside cladding surface; this is due to higher temperatures at the inner surface because of fissions on or very near the corroding surface.

The Shippingport LWBR core contained 12 hexagonal-shaped modules, which were arranged in a symmetric array, surrounded by 15 reflector modules. Each of the hexagonal modules contained a central movable fuel assembly (seed) surrounded by a stationary blanket assembly. The fuel was in the form of ceramic pellets that were sealed within Zircaloy-4 tubes. In the seed and blanket regions, the fuel pellets were composed of the mixed oxides of ^{233}U and ^{232}Th in solid solution. In the reflector region and in short sections at the tops and bottoms of the seed and blanket fuel rods, the pellets were ThO_2 . The seed-blanket-reflector configuration of the LWBR core had 17,287 fuel rods. LWBR fuel rod cladding was used in two metallurgical conditions, recrystallization annealed (RXA) seed rod tubing and stress-relief annealed (SRA) blanket and reflector rod tubing. Fuel rods were maintained in close-packed hexagonal arrays by AM-350 stainless steel grids. The LWBR core operated for about 29,000 EFPH. The absence of high coolant activity indicated that there were no fuel rod cladding defects.

Hydrogen transport through the fuel-cladding gap can also occur in irradiated defected fuel rods by the following sequence of events. First coolant enters the rod through the defect and oxidizes the inner zircaloy cladding surface through the reaction: $\text{Zr} + 2\text{H}_2\text{O} \rightarrow \text{ZrO}_2 + 2\text{H}_2$. The hydrogen that is not absorbed by the zircaloy (about 75%) is released to the fuel-cladding gap, thus enriching the atmosphere in hydrogen. In addition, some of the coolant entering the defect is decomposed to hydrogen and peroxide by radiolysis, $2\text{H}_2\text{O} \rightarrow \text{H}_2\text{O}_2 + \text{H}_2$. Thus the oxidant partial pressure is reduced both by corrosion of the internal surface of the zircaloy cladding and by peroxide oxidation of the fuel. High levels of free hydrogen generated by the radiolysis of the coolant and fuel and cladding oxidation can migrate through the fuel-cladding gap to the end regions of the defected rod where the hydrogen is absorbed.

C4.8.2 Experimental Details

Irradiation testing of defected fuel rods played an important role in development of fuel elements for the LWBR core. The LWBR irradiation test program encompassed 30 individual tests of 271 fuel rods. The test rods were irradiated either in standard specimen holders or in bundles resembling portions of LWBR fuel rod modules. The coolant for these irradiation tests was pressurized water maintained at pH 10 by NH_4OH additions. Nineteen fuel rods (14 seed and 5 blanket) were intentionally defected with drilled holes prior to testing. A larger (~35 mil diameter) spotting hole was first drilled halfway through the cladding wall from the outside surface and then continued through the wall to the inside surface with a smaller (~5 mil diameter) defect hole. The fuel stacks of some of the defected rods were short (6–11 in. in length). However, five seed rods and four blanket rods were of LWBR length, i.e., up to 118 in. long. Holes were located about halfway up the fuel stack on short rods and within 24 in. of the bottom on long rods, except on seed rod 79-443D where the hole was located at the bottom end plug-pellet stack interface. In addition, two blanket rods, which were irradiated at higher heat ratings than LWBR core rods, developed small cladding defects during planned in-service transient testing.

All 21 defected rods successfully operated with limited radioactivity release to the coolant. Startup activities, i.e., the values measured immediately after a defected test rod reached full power following a shutdown, were 5–10 times greater than the steady state activities due to release of fission products to the coolant. These high activities declined over a period of 1 to 3 days to the steady state level. The steady state coolant activity values of irradiation tests with defected rods were higher than similar tests containing only nondefected rods. For example, the ^{138}Cs activity in the GRIP IIIA test with defected rod 79-614D was 1×10^5 dpm/mL compared to an activity value of 5×10^4 dpm/mL for the GRIP IIIC test with no defected rods. Irradiation histories of the 21 LWBR defected rods, including the two which defected in-pile, are given in the report. The fuel rods with intentionally fabricated defects are identified by the letter “D” after the rod number. The seed-size irradiation test rods with RXA cladding were irradiated to peak depletions up to 12×10^{20} f/cc and peak fast neutron (>1 Mev) fluences up to 101×10^{20} n/cm². The peak depletion and fluence for the LWBR core seed rods were 11×10^{20} f/cc and 97×10^{21} n/cm², respectively. The blanket-size test rods with SRA cladding were irradiated to peak depletions up to 4×10^{20} f/cc and fluences up to 12×10^{20} n/cm². The peak depletion and fluence for the LWBR core blanket rods were 5×10^{20} f/cc and 74×10^{20} n/cm².

The objectives of the LWBR irradiation test program were:

- To test fuel rods under heat fluxes, fast neutron fluxes, and fuel depletions expected in the LWBR core
- To confirm satisfactory performance for design lifetime
- To support development of performance analyses for LWBR fuel rods.

The program for measuring corrosion and hydriding in Zircaloy-4 cladding of defected fuel rods consisted of rods from the 14 tests given in Table C-12.

Table C-12. LWBR defected irradiation tests containing fuel rods examined for cladding corrosion and hydriding.

Designation	Test Name	Rod Type	Heat Treat Cladding	Test Reactor
M-13-S2	Seed Rod Screening	Seed	RXA	ETR
M-13-S3	Seed Rod Screening	Seed	RXA	ETR
M-13-S3A	Seed Rod Screening	Seed	RXA	ETR
M-13-S4	Seed Rod Screening	Seed	RXA	ETR
GRIP II	Grid Rod In-Pile	Seed	RXA	ETR
GRIP IIIA	Grid Rod In-Pile	Seed	RXA	ETR
GRIP IIIB	Grid Rod In-Pile	Seed	RXA	ATR
LSR	Long Seed Rod	Seed	RXA	NRX
—	Production Thoria	Seed	RXA, SRA	ETR
C-7B3	Blanket Screening Test	Blanket	SRA	ETR
C7-B3A	Blanket 6-Rod Assembly	Blanket	SRA	ETR
C7-BBT	Blanket Bundle Test	Blanket	SRA	ETR
SBR	Short Blanket Rod	Blanket	SRA	NRX
NLBR	New Long Blanket Rod	Blanket	SRA	NRX

C4.8.3 Postirradiation Examination Results

All of the defected rods were visually examined. The inside and outside corrosion cladding-surface oxide thickness was measured for 16 of the defected rods on at or near the fuel rod peak power position. The same 16 rods were analyzed for hydrogen content and distribution. Summaries of internal and external cladding-corrosion data for the 16 LWBR irradiated defected test fuel rods that were destructively examined are presented for RXA and SRA Zircaloy-4 cladding. External corrosion-oxide thickness measured on the defected fuel rods was about the same as those of nondefected rods with similar irradiation histories.

Nine of the intentionally fabricated defected rods had a white or gray streak downstream from the defect hole (streamers). The defect hole streamer of GRIP IIIB Rod 79-609D was observed at the first interim examination (1330 EFPH). At 2360 hours, the streamer consisted of a bright white area and a darker phase extending downstream from the defect hole and increasing in width as the distance from the hole increased. With continued irradiation the white portion increased in area and covered the darker phase. Postirradiation examination confirmed the streamer to be ZrO_2 . The nine oxide streamers were local and had no noticeable effect on general cladding integrity. It is thought that either eroded ThO_2 fuel or fission products emanating from the defect hole caused the accelerated corrosion of the zircaloy cladding.

Internal cladding surface oxide films in the defected rods were usually more variable in thickness and several times thicker than the external oxide films. The thicker inner-surface corrosion films are due to several factors: higher internal cladding surface temperatures (up to $780^\circ F$), fission-induced corrosion acceleration at the internal surface and exposure to a steam environment. The internal film on Rod 79-587, however, was thinner than the external film because the rod was removed from test about 8.5 hours following the planned up-power transient test that produced the defect. Four of the intentionally fabricated defected rods experienced cladding swelling. Rod 79-504D swelled along the primary fuel stack. Three rods (79-433D, 79-307D, and 79-583D) had periods of normal dimensional changes during irradiation before any significant swelling, mainly in the plenum region, was detected. Blockage or partial blockage of the defect hole occurred in all four rods. The combination of hole blockage and swelling is indicative of water logging, i.e., excessive internal pressure built up by trapped coolant, which deforms the cladding.

C4.8.4 Zircaloy-4 Cladding Hydriding

Measured hydrogen pickups in irradiated LWBR nondefected test rods and autoclaved Zircaloy-4 tubing specimens were proportional to measured outside diameter corrosion thickness. The hydriding in defected Zircaloy fuel rods falls into three categories: expected due to corrosion, accelerated, and massive. Expected hydrogen pickup in defected rods results from the additional hydrogen which enters the cladding through the inside diameter ZrO_2 film during corrosion. Twelve of the 16 destructively examined defected LWBR test rods exhibited normal behavior of this type (~ 100 – 1000 ppm H_2). Accelerated hydriding is defined as hydrogen absorption from the coolant far in excess of the nominal 25% pickup fraction of free H_2 produced by the $Zr-H_2O$ corrosion reaction for Zircaloy-4 (\sim several thousand ppm). Massive hydriding is the formation of regions of delta phase zirconium hydride in the cladding due to grossly accelerated hydrogen pickup (16,300 ppm).

The hydrogen contents of Zircaloy-4 cladding samples from the LWBR intentionally defected test rods are summarized in the report. Measurements were made with a vacuum extraction technique and by visual comparison with known metallographic standards. Because of the greater internal surface corrosion, the total hydrogen contents in the defected rod cladding were several times those in nondefected rod cladding with similar irradiation histories. For example, in the GRIP-IIIA test, defected

rod 79-614D had 174 ppm hydrogen in the peak power region, whereas companion nondefected rod 79-617 had only 40 ppm hydrogen. Hydrogen pickup in nondefected fuel rods is proportional to corrosion oxide thickness and, therefore, is greater in peak power positions than in cooler, low power regions. In contrast, several defected test rods (79-433D, 79-443D, 79-609D, and 79-614D), that were examined at several power positions, had higher hydrogen contents in cooler, low power cladding regions where the corrosion was less. Also, due to the steep temperature and higher hydrogen concentration radial gradients in defected rods, hydrogen tends to diffuse from the hotter inside cladding surface to the cooler outside surface; this results in higher hydrogen concentrations at the outside cladding surface.

Several instances of localized accelerated and massive hydriding were observed. Two intentionally fabricated defected fuel rods (GRIP-II rod 79-443D and GRIP-IIIB rod 79-609D) had areas of accelerated hydriding with several thousand ppm of hydrogen. Localized areas of massive hydriding were found in C7-B3A rod 79-353, GRIP-II rod 79-441D, and GRIP-IIIB rod 79-609D. These localized areas were converted to solid zirconium delta hydride (~16,300 ppm H₂). Massive hydriding was also accompanied by dimensional changes in these three rods due to the lower density of zirconium delta hydride compared with Zircaloy-4. However, none of these incidents interfered with the operation of the irradiation tests. For example, C7-B3A rod 79-353, which defected in-pile due to iodine stress-corrosion cracking, operated successfully for about 12,000 EFPH even though during postirradiation examination the cladding was observed to be massively hydrided near the bottom end of the rod. None of these hydrided rods lost additional structural integrity during operation, which attests to their ability to function under localized accelerated and massive hydriding conditions.

C4.8.5 Summary of Corrosion and Hydriding Behavior

Oxide films on internal surfaces of defected Zircaloy-4 fuel rods were several times as thick as films on external surfaces. This can be explained both by higher temperatures at the internal surface and by the effect of surface fissile enhancement.

Total hydrogen contents in defected fuel rod cladding were several times those in nondefected rod cladding. Further, evidence of hydrogen migration to cooler regions of the rods remote from the defect hole was observed, indicating that hydrogen pickup is not proportional to corrosion oxide thickness.

Hydrogen levels in the cladding of the defected fuel rods were generally higher at the external surface than at the internal surface because, in a sufficiently high thermal gradient, hydrogen diffuses toward the cooler region.

Defected rods with areas of accelerated or massive hydride continued to operate satisfactorily.

C4.8.6 Conclusions

- The measured outer surface zircaloy cladding corrosion oxide thickness of both defected and nondefected LWBR irradiation test rods were similar and can be calculated using a model based on nondefected outer surface corrosion experience.
- There is a significant corrosion enhancement on the inside-cladding surface in defected zircaloy fuel rods that can be attributed to radiation damage caused by fission product recoil.
- When modified to account for the additional corrosion caused by fission activity on the inner zircaloy cladding surface, a model qualified to the corrosion of nondefected rods provided calculated values that agree well with measured inner oxide corrosion film values.

- Hydrogen concentrations are higher than predicted in the lower power segments of defected zircaloy fuel rods and are not proportional to oxide thickness. This phenomenon is attributed to gaseous hydrogen transport through the fuel-cladding gap; this results in high hydrogen concentrations in the gap at the top and bottom ends of the defected rod.
- Hydrogen absorption models in which hydrogen pickup is calculated to be directly proportional to local corrosion oxide weight gain, while adequate for the prediction of external hydriding in nondefected rods, are unsuitable for prediction of axial hydrogen distribution in defected zircaloy rods.

C4.9 Iodine and Cesium in Oxide Fuel Pellets and Zircaloy-4 Cladding of Irradiated Fuel Rods (Ivak and Waldman 1979, WAPD-TM-1394)

Measurements of fission product iodine and cesium are reported for thorium and binary (ThO₂-UO₂) fuels with various irradiation histories. These volatile fission products were measured on the cladding surface or in the fuel by using specially developed radiochemical techniques. The radiochemical iodine measurements are in agreement with a theoretical iodine release model for irradiated fuel. Microprobe examinations of irradiated fuel rod cladding sections show fission product cesium to be located preferentially at the pellet to pellet interface region. Fission product iodine was detected in the interface microprobe-limit region of one sample but generally remained below the limit of detection.

Twenty-two fuel rods were analyzed for this report; ten of the 22 rods are contained in the scrap canister. The rod identification numbers of the 10 rods are listed in Table C-13.

Table C-13. Rod identification numbers.

79-353	79-449	79-576	79-605	79-617
79-442	79-572	79-587	79-610	79-671

Rod 79-587 failed in-pile during up-power transient.

The iodine and cesium concentrations obtained from radiochemical analysis of the 22 test-rods are given along with a summary of the irradiation history of each test rod. Electron microprobe examination of cladding segments from four irradiation test rods was also conducted to determine iodine and cesium distribution on the inside diameter surface of cladding. A brief summary of the results for two of the rods that are contained in the scrap canister is presented below.

Rod 79-442—One of the two locations, corresponding to a pellet interface location on the clad surface had only barely detectable amounts of cesium. The second interface location displayed only background levels. No iodine, cadmium, tellurium or mercury was detected above the background levels anywhere on the sample.

Rod 79-576—One of the two pellet-to-pellet interfaces on the cladding surface showed a relatively strong indication of cesium. No iodine, mercury, cadmium, or tellurium was detected above the sample background levels.

The conclusions of the report were as follows:

- There is essential agreement of microprobe evaluation with the low-level of iodine found by radiochemical analysis. Results of both radiochemical and microprobe examinations suggested less iodine than calculated using the iodine release upper-bound calculation model. In one case, the radiochemical iodine measurement was greater than the upper bound model. Remeasurement of this rod, 79-617, showed a decrease in the iodine concentration to a level well below the upper-bound calculation. The upper-bound iodine calculation method presented in the report is therefore corroborated by the radiochemical data.
- The presence of other volatile fission products on the cladding, cesium, and tellurium were confirmed by electron microprobe evaluation. The cesium concentration obtained from radiochemical data was on the cladding in greater concentration than iodine, as might be expected due to its higher fission product yield. Similarly, the failure to detect cadmium on the cladding during microprobe examination was probably due to its extremely small fission product yield.

C4.10 Corrosion and Hydriding of Irradiated Zircaloy Fuel Rod Cladding (Clayton 1982, WAPD-TM-1440)

Metallography and other destructive examinations were performed on some of the test samples. After collection of internal atmosphere gases, LWBR irradiation test fuel rods were sectioned to provide samples for measuring depletion, fluence, and hydrogen content and for metallographic evaluation. Metallographic samples were mounted in Hysol epoxy resin, which locked the fuel pieces in place and preserved the corrosion oxide for examination. Each piece was pressure-mounted by immersion in the epoxy resin pressurized to 1000 psi. A silicone rubber sleeve was used to isolate the outside cladding surface from the Hysol while it was immersed in Hysol for 24 hours at room temperature. The Hysol was cured for 2 hours at 200°F. The pressure-mounted pieces were sectioned with a diamond cutoff wheel to provide both transverse and longitudinal metallographic samples. More details about the sample preparation and the results are provided in Clayton 1982.

Nondestructive examinations of the rods consisted of visual examinations, dimensional measurements, gamma ray scanning, and neutron radiography; dimensional measurements consisted of measuring the overall length and diameter of the cladding; gamma ray scanning and neutron radiography were used to determine the condition of the internal rod components.

Irradiation histories of 47 LWBR test fuel rods 29 with RXA cladding and 18 with SRA cladding are given. The rod identification numbers of 25 of these rods, which are contained in the scrap canister, are given in Table C-14.

Table C-14. Rod identification numbers.

79-349	79-513	79-575	79-610	79-623
79-405	79-514	79-576	79-613	79-624
79-442	79-570	79-579	79-617	79-631
79-449	79-572	79-605	79-619	79-632
79-509	79-573	79-608	79-621	79-656

The results of the study are summarized below.

- CHORT predictions compare well with measured corrosion data from out-of-pile autoclave tests on LWBR Zircaloy-4 tubing.
- Corrosion thickness and hydrogen uptakes in LWBR irradiation test program fuel rod Zircaloy-4 cladding are less accurately accounted for by the CHORT program due in part to measurement scatter and material variability.
- Both out-of-pile and in-pile test data indicate that SRA Zircaloy-4 corrodes faster than RXA Zircaloy-4 does.
- Measured corrosion thickness of Maine Yankee, Kernkraftwerk Obrigheim, Turkey Point, and MELBA fuel rods are in reasonable agreement with CHORT predictions.

C4.11 Irradiation Performance of Duplex Fuel Pellet Test Rods Depleted to 9×10^{20} Fissions/cm³ of Compartment—D-1 Test (Sphar, Mertz, and Roesener 1982, WAPD-TM-1460)

This report evaluated the irradiation performance of the D-1 test, which was a screening test of the duplex pellet prebreeder reactor fuel concept. The duplex pellet consisted of a cylindrical thoria pellet surrounded by an annulus containing urania enriched in U-235. The duplex pellet geometry offered the advantage of lower fuel temperatures than solid pellets for equal power output and provided a means of including the fertile material in the fuel rods with little or no loss of heat transfer surface while also providing a practical (chemical) means for separating the U-233 bred in the thoria central core without contamination by other uranium isotopes in the annulus. The test was conducted on duplex pellet annuli of four different compositions: UO₂, ZrO₂-UO₂, ZrO₂-UO₂-CaO and ThO₂-UO₂. Rods were irradiated, and destructive and nondestructive examinations were conducted.

The rod identification numbers of the rods used in the D-1 test are listed in Table C-15.

Table C-15. Rod identification numbers.

97-1	97-16	97-24	97-32	97-41
97-5	97-17	97-25	97-33	97-42
97-11	97-19	97-27	97-34	97-48D
97-12	97-20	97-28	97-36D	
97-13D	97-21	97-29	97-37	
97-14	97-22	97-30	97-39	
97-15	97-23	97-31	97-40	

The D-1 Test rods are 11 in. in length by 0.3 in. in diameter and consist of top and bottom Zircaloy-4 end- closures welded into seamless Zircaloy-4 cladding tubes. Cladding tube heat treatment is incorporated as a test variable. Rods were fabricated with recrystallization-annealed tubing or highly cold-worked stress-relief annealed tubes. Contained within the cladding tube are an 8-in. stack of fuel pellets and a 0.8-in. long plenum region containing an Inconel-X spring. Five different fuel stack arrangements were used for each of the duplex-annulus material type. These arrangements are designed to

test various sizes and configurations of solid thoria spacers that maintain alignment of the duplex pellet components in the fuel stack. Each rod contains a solid cylindrical pellet, with about half the fuel loading of the duplex pellets, at each end of the duplex pellet stack. These pellets reduce power peaking at the ends of the pellet stack. Thoria pellets are incorporated on the outboard side of the power peaking suppressor pellets, against the bottom end closure and against the plenum spring; this is done to limit operating temperatures of the bottom end closures and the plenum spring. The four-annulus compositions tested in the D-1 rods are listed in Table C-16.

Table C-16. Compositions in the D-1 rods.

Annulus	UO ₂ w/o	ZrO ₂ w/o	CaO w/o	ThO ₂ w/o	²³⁵ U Enrichment (%)
UO ₂	22.3				22.3
ZrO ₂ -UO ₂	34.0	66.0			97.7
ZrO ₂ -UO ₂ -CaO	36.9	58.1	5.0		97.7
ThO ₂ -UO ₂	33.8			66.2	93.1

The UO₂ fuel was included because it is the fuel most commonly employed in commercial reactors. The ZrO₂ based fuels were included because they contain essentially no ²³⁸U. Absence of ²³⁸U results in a significant neutron economy advantage. Inclusion of the thoria based binary fuel extends the technology developed in the LWBR program for solid pellets with this fuel system to include the duplex pellet geometry.

Other D-1 test variables are: (1) magnitude of initial diametric clearance gap between the annuli and cladding and between the annuli and central pellets, (2) levels of rod internal prepressurization, and (3) defect operation.

Diametric clearance gaps between the annuli and cladding ranged from 45–84 mils, which is in the range of current commercial design practice. The gaps between annuli and the thoria central pellets were varied from 24–102 mils to investigate the effect of a wide range of this parameter on rod performance.

The principal advantages of prepressurization are: (1) increased margin to cladding collapse in the presence of an axial gap between fuel pellets and (2) decreased degradation of the thermal conductivity of the rod's internal atmosphere as fission gases are released from the fuel. Degradation in gap thermal conductivity is lessened by the increased concentration of higher conductivity helium as compared with released fission gases. In addition, there is reduced cladding “creep-down” due to the reduced pressure differential across the cladding which delays fuel-cladding interaction, reduces cladding strain, and reduces the potential for formation of fuel stack gaps. On the other hand, higher internal pressure reduces the loss-of-coolant accident performance capability with respect to an unpressurized rod. Therefore, it is desirable to optimize the initial pressure level within the rods. To study these effects, initial helium pressures of 100 and 500 psig at room temperature were selected.

Although not included in the original test, rods containing intentional defects in the cladding were introduced as replacement rods for the UO₂ and ThO₂-UO₂ rods terminated for destructive examination at an early stage. The intentional defects, included to investigate the behavior of rods with breached cladding, were in the form of 5-mil diameter holes drilled through the cladding at the approximate axial midplane of the rods.

The prime characteristics and variables of the individual D-1 test rods are given in the report.

C4.11.1 Fuel Components

Annuli—The outside chamfers at the pellet ends and the perpendicularity control were specified to minimize frictional forces between the fuel pellets and the cladding as the fuel stack lengthens and shortens with power changes. The chamfer eliminates sharp corners on the pellet while the limits on end face nonperpendicularity reduce pellet tilting tendencies and resulting radial forces of the pellet against the cladding. The chamfers also minimize the potential for creation of chips during rod loading. Chips, if present in the rod, may increase local strains in the cladding. The length-to-diameter ratio of the duplex-pellet annulus (2.1) is consistent with that of the LWBR seed pellets. The annulus wall thickness provides a nominal-annulus-to-central core cross sectional area ratio of unity that was considered acceptable with respect to manufacturing limitations and integrity during irradiation. With this 50/50 split, the volumetric heat generation rate and depletion of the annulus is about twice that of solid pellets producing equal power.

The annulus outside-diameters are sized to provide clearance gaps in the range of present commercial practice, which avoids premature fuel-cladding contact. Large radial gaps reduce heat transfer capability and increase fuel temperatures. Increases in fuel temperatures must be limited to avoid fuel structural changes or melting which can lead to cladding failure. The UO₂ rods and the ThO₂-UO₂ rods contain fuel-to-cladding diametric gaps in the range 49–85 mils. Because of poorer heat conduction properties, the Zirconia-based fuels have fuel-to-cladding gaps in the 45–58 mil range.

High density (>96% TD) was desired for all fuel materials to maximize thermal conductivity, thereby resulting in higher power production at the maximum allowable temperature of the fuel. In addition, high density minimizes fuel dimensional changes in service and consequent axial shrinkage of the fuel stack. Axial shrinkage in rods of commercial length might lead to collapse of unsupported cladding if axial gaps were to form between pellets.

The densities (derived from pellet dimensions and weights) of the annular fuel materials are as listed in Table C-17.

Table C-17. Density of annular fuel materials.

Fuel Material	Density (Percent TD)		
	Average	Maximum	Minimum
UO ₂	95.1	96.5	93.1
ZrO ₂ -UO ₂	92.4	93.1	91.6
ZrO ₂ -UO ₂ -CaO	94.0	95.0	93.3
ThO ₂ -UO ₂	96.7	96.0	97.2

The fuel-to-cladding gap for the ZrO₂-UO₂ annular pellets was set about 1 mil below the gap sizes for the other fuel compositions to compensate for the lower density.

C4.11.1.1 Thoria Central Pellets. The thoria central pellets were prepared from available LWBR seed thoria pellets. The LWBR pellets, of about 98.8-percent TD, were nominally 0.256 in. OD and 0.530 in. long. The end dish depth and corner chamfers were 9 and 15 mils, respectively. Outside diameters of the thoria central pellets were ground to different sizes to obtain a range of annulus-to-central pellet diametric gaps. This was done as a test variable to evaluate the effect of central pellet eccentricity in the annulus on pellet temperatures and the effect of total clearance gap on fuel-cladding interaction. The length of the central cores was made less than that of the annuli to ensure that

the annular pellets are longer than the central pellets at the highest predicted operating temperature and thus avoid axial gaps between the annuli.

C4.11.1.2 Thoria Spacers. Thoria spacers separating the duplex pellets may be necessary to maintain the axial alignment of the fuel stack. The effect of these spacers is investigated in the seven test rods of each fuel material by varying the length of the spacers (0.050, 0.100, and 0.530 in.) and the number of duplex pellets between spacers. The rods range from no spacers in the duplex pellet stack to having a spacer at each duplex pellet interface. These were prepared by slicing long pellets transversely and breaking the corners by tumbling in silicon carbide grit. The outside diameter of these thin spacers is nominally the same as the duplex pellets of the particular rod in which the spacers are located. The design of the 0.530-in. long spacer is the same as for the LWBR seed thoria pellets. The concave dish in each end of 0.530-in. spacer reduces the convex shape that would exist at power in a flat and ended pellet. Reduction of the convex contour minimizes axial expansion fuel-cladding interaction. The outside diameter of the long thoria spacers matches the outside diameter of the duplex pellets of the rod in which they are located.

C4.11.1.3 Thoria End Pellets. One long spacer was used at the bottom of the fuel stack in each rod to reduce operating temperatures at the end closure insert. The thin thoria spacers were used as required at the top of the fuel stacks to reduce operating temperature of the plenum spring and to achieve the desired overall fuel stack and plenum lengths in the rods.

C4.11.1.4 End Peak Suppressor Pellets. Power peaking is significant at the ends of the fuel stack of these short rods, which are in the high flux region of ends of the ATR. To limit this end peaking to acceptable values, $\text{ThO}_2\text{-UO}_2$ pellets with fissile loading about 40% of the annular pellets were positioned at the top and bottom of the fuel stack of each rod. The design of these flux suppressor pellets is the same as the long thoria pellets except that they are 0.58 in. long.

C4.11.2 Nonfuel Components

C4.11.2.1 End closures. The end closures, which were Tungsten Inert Gas welded into the cladding tube, were machined from Zircaloy-4 bar stock. The bottom end closure is designed to provide lateral, axial, and rotational restraint of the rod in the test holder while the top end closure provides lateral restraint but permits limited axial motion.

C4.11.2.2 Plenum Springs. The 0.785-in. long plenum region above the fuel stack contains an Inconel-X spring that provides a preirradiation axial load of 1.82 lb on the fuel stack. This force is about 12 times the fuel pellet stack weight and restrains the pellet stack from shifting during handling and shipment of the rods.

C4.11.2.3 Cladding. The Zircaloy-4 cladding for the D-1 test rods was fabricated by the Wolverine Tube Division of Universal Oil Products. Both RXA and SRA conditions were used; the properties are given in Table C-18. The outside diameter of the RXA tubing was decreased by about 4 mils to produce an outside diameter-to-thickness ratio (OD/t) of 13.9, which is representative of the LWBR seed rod design. The SRA tubing diameter was decreased by about 11 mils to produce an OD/t of 16.0, which is typical of commercial reactor practice. The outside diameters reductions were achieved by pickling in a mixture of hydrofluoric and nitric acids following fuel rod assembly.

Table C-18. Properties of tubing for D-1 test rods.

	RXA	SRA
As Fabricated outside Diameter (mil)	308±1	308±1
Inside Diameter (mil)	259±1	259±1
Wall Thickness (mil)	24.5	24.5
Final Heat Treatment (°F/hr)	1225/4	925/4
Cold-work, last of 3 Passes (%)	51	51
ASTM Grain Size	10	NA
Longitudinal Tensile Properties at 700°F		
0.2% Yield Stress (psi)	19,000	44,000
Ultimate-to-Yield Ratio	1.73	1.27
Total Elongation (%)	34	13
Contractile Strain Ratio	1.44	1.35
Chemistry (Billet Analysis)		
Hafnium (ppm)	23	23
Hydrogen (ppm)	4	4
Nickel (ppm)	30	30
Nitrogen (ppm)	30	30
Oxygen (ppm)	1300	1300

C4.11.3 Test Train Design

The in-pile hardware design used for the AWBA D-1 test was available from short rod tests in the LWBR Irradiation Testing Program. The D-1 rods are supported in the in-pile hardware by means of the end stems. The bottom, spade-shaped end stems of the rods are inserted through the bottom base plate. Flats on the portion of the end stem engaged by the base plate prevent rotation of the rods. A locking plate goes over the spade ends and slides laterally engaging the spade ends to prevent axial movement of the rods. The round, cone-tipped end stems at the top of the rods are inserted through mating holes in the upper locator plate. The distance between the bottom base plate and the top locator plate is 0.2 in. larger than the shoulder to shoulder length of the rods. This allows for free elongation of the rods by thermal expansion and axial clad strain. In the holder internals, the rods have the cross-sectional array. The rods are arranged on a square pitch of 0.355 in. with rod spacing of 0.052 in. The internal surface of the holder half shells are sculpted to represent the shape of additional rods, thus giving a flow pattern representative of a larger rod array.

The results of the study are summarized below.

C4.11.4 Nondestructive Examinations

C4.11.4.1 Rods Without Intentional Cladding Defects. Visual examinations of rods without intentional cladding defects resulted in no observations of irradiation-induced effects that raise concern over rod performance. Early stage corrosion in the form of isolated small white spots was observed on some rods at an early state of irradiation but did not appreciably worsen with irradiation.

Rod cladding dimensional measurements, overall length and diameters, in general indicate that fuel-cladding interaction has not yet become significant in the D-1 test rods.

At a fast neutron fluence of 25×10^{20} n/cm², the maximum reached by any of the rods, overall length strains were at most 0.24% for rods with SRA cladding and 0.12% for rods with RXA cladding; the strains are principally the result of stress-free zircaloy growth. The expected effects of rod internal prepressurization are evident in those rods with higher internal pressure that exhibit smaller length changes than rods with lower internal pressure.

Because of the lack of fuel-cladding interaction during the first half of test life, the diameter changes continued the trend of diameter shrinkage. Cladding heat treatment and thickness, level of rod internal BOL pressurization, and fast neutron fluence are the determining effects. The SRA clad rods with their thinner wall show greater diametric shrinkage than the RXA clad rods. Rods with higher fast neutron fluence show greater shrinkage. Furthermore, within the cladding material categories, the rods with lower BOL pressure show greater shrinkage due to the higher-pressure differential across the cladding.

Only one rod clearly shows onset of fuel-cladding interaction. Diameter traces for this rod reveal irregularities that correlate with the fuel stack components. Fuel-cladding contact was expected to occur first in this rod because of the unfavorable combination of characteristics, which included stress relief annealed cladding, low internal prepressurization, small-fuel-cladding clearance-gap, and high power rating.

Nondestructive examinations aimed at determining the condition of the internal rod components were gamma ray scanning and neutron radiography. The internal components of the rods did not have any abnormalities of intentional defects. Fuel stacks were shown to be in good condition with no evidence of pellet crushing or development of gaps between pellets. The various sizes and configurations of ThO₂ spacers performed satisfactorily.

The lengths of the fuel stacks in the D-1 rods were measured from the neutron radiographs and compared with the preirradiation fuel stack length changes. Observed changes ranged from -1.3 to +1.5%. Although data at depletions beyond $\sim 1 \times 10^{20}$ f/cc-compartment are limited, tentative trends in fuel stack behavior were observed which correlate with duplex-pellet annulus material. The UO₂ annulus rods showed small increases or decreases in stack length (-0.40 to +0.15%) at depletions $< 1.5 \times 10^{20}$ f/cc-compartment. However, the one rod, which was radiographed a second time, at depletion of $\sim 6 \times 10^{20}$ f/cc-compartment had stack elongation of 0.39% following early-in-life shrinkage of 0.20%. This implies that following some early-in-life densification, fuel swelling becomes dominant.

Early-in-life fuel stack shrinkage was observed in the rods with ZrO₂-UO₂-CaO duplex pellets (ranging from 0.29%–0.45%) with no change during subsequent irradiation for the one rod radiographed again at depletion of $\sim 6 \times 10^{20}$ f/cc-compartment. Thus, it may be that in the ternary fuel swelling is less than for UO₂ and/or that densification is greater. The initial density, in terms of percent of theoretical, was lower for the ternary fuel (93.2% TD) than for the UO₂ fuel (95.5% TD).

Three rods with ThO₂-UO₂ duplex pellet annuli were subjected to neutron radiography. Fuel stacks in all three elongated with a nearly linear growth rate of about 0.14% per 10^{20} f/cc-compartment.

The ThO₂-UO₂ rods had substantial shrinkage (up to 1.3%) at depletions above 2×10^{20} f/cc-compartment after initial increases; the increases are attributed to accumulation of small separations associated with the more extensive early-in-life cracking of the ZrO₂-UO₂ annuli as compared to the others. The subsequent shrinkage may be associated with lower in-pile creep-strength of the

ZrO₂-UO₂ material. Evidence of dimensional instability of the ZrO₂-UO₂ annuli was revealed by destructive examination of rod 97-22.

Based on these nondestructive examination results, it was concluded that performance of the duplex-pellet fuel system is quite good. Cladding and fuel pellet integrity was maintained, and dimensional changes were compared favorably with results of solid pellet tests previously conducted as part of the LWBR development program.

C4.11.4.2 Rods with Intentional Cladding Defects. Nondestructive examinations of rods with intentional cladding penetrations revealed several features of interest not observed on nondefected rods.

On the external cladding surfaces of rods with intentional cladding defects, flow patterns downstream from the intentional defect holes were observed. The most extensive flow pattern was observed on the rod that contained duplex pellets with UO₂ annuli. The one other defected rod irradiated for a long time contained ThO₂-UO₂ annulus duplex pellets and evidenced a flow pattern that was much less extensive than for the UO₂ rod. This indicates that the ThO₂-based fuel may be less susceptible to erosion and corrosion than the UO₂ fuel.

Circumferential white corrosion rings were observed on the cladding of the defected rod with ThO₂-UO₂ fuel at the locations of 50-mil thick thoria spacers separating duplex pellets in the fuel stack. Neutron radiography and preliminary metallographic examination of the cladding from this rod demonstrated that the white corrosion rings are associated with substantial nonuniform concentrations of hydrogen in the cladding; the regions affected by the corrosion rings coincided with the regions of heaviest hydrogen concentration. Preliminary destructive examination results also indicate that the primary source of the hydrogen was accelerated corrosion of the cladding inner surface during irradiation in the defected state. The fuel stack arrangement in this rod consists of pellets containing the fissile material (with high heat generation) interspersed with the ThO₂ spacers (with lower heat output) and generates hydrogen "cold traps" in the cladding.

The circumferential white corrosion rings on the cladding external surface, coincident with the regions of high hydrogen concentrations, are thought to be a result of the hydriding. Diameter measurements revealed ridging of the cladding at the locations of the corrosion rings; the average diametric ridge height was 0.8 mils with a maximum of 1.2 mils. This ridging was probably caused by the cladding-material volume increases associated with the extensive hydriding from internal cladding corrosion. Subsequent development of the external accelerated corrosion rings resulted from disturbances in the protective corrosion film due to local straining and/or perhaps reduced corrosion resistance of zirconium hydride. In the intentionally defected rod with UO₂ duplex pellets, irregularities in gamma ray intensity from a pellet near the defect hole were observed. Neutron radiography of this rod revealed the abnormality to be a fractured pellet with some rearrangement of the pellet fragments. The damage to the duplex pellet is believed to be the result of forces generated by the pressure buildup release through the defect hole during rod startup. The damage occurred during the first 30 days of irradiation and did not noticeably worsen during 118 days of additional irradiation.

These abnormalities are the result of defect operation and are not specifically related to the duplex pellet fuel design. The local high concentration of hydrogen in the cladding was caused by variations in cladding temperature associated with the alternating arrangement of fissile and fertile fuel pellets in the fuel stack. This problem can be solved by eliminating the thoria spacers and using other methods to maintain axial registry of the duplex pellet components. Fractured pellets near intentional defect holes have also been observed in previous LWBR tests with solid pellets.

C4.11.5 Destructive Examinations

Destructive examinations were not completed for nondefected rods and only started on the ThO₂-UO₂ rod with intentionally defected cladding.

Over the depletion ranges covered, fission gas release percentages were for all four fuel systems being investigated in the D-1 test and appeared to depend on fuel depletion more than on fuel material. The highest release measured is 1.75% for a ThO₂-UO₂ rod with depletion in the annulus material of 18.9×10^{20} f/cc. UO₂ and ZrO₂-UO₂-CaO rods with depletions of $\sim 12 \times 10^{20}$ f/cc had lower gas release, roughly in proportion to the annulus depletion.

Metallographic evaluations of the fuel components demonstrated that, macroscopically, all components appeared to be in good condition. Cracking of the duplex pellet components and the thoria spacers was observed, but geometrical integrity was maintained with no evidence of crushing or crumbling. No evidence was found for any of the fuel types of mass transport by evaporation of material from the high temperature (inside) surface of the duplex pellet annuli and condensation in colder regions of the rod.

The metallographic samples were analyzed using a Quantimet 720 Image Analyzing Computer to determine the total porosity and porosity-size distributions in the duplex pellet annuli. For all fuel material types, total porosity decreased during early irradiation. For the UO₂ fuel, continued irradiation to 13.0×10^{20} f/cc of annulus material resulted in continued reduction of porosity. For the ZrO₂-UO₂-CaO fuel, the existence of nonuniformly distributed large pores resulted in high variability of the Quantimet results and larger uncertainties in the porosity volume percents. However, disappearance of small-fabricated porosity early in life and emergence of very fine porosity believed to be fission gas bubbles with continued irradiation to 13.0×10^{20} f/cc of annulus material is evident. The ThO₂-UO₂ fuel, irradiated to the highest depletion (18.9×10^{20} f/cc of annulus material), also shows emergence of very small fission gas bubbles after initial disappearance of small pores; the translucency of the fuel and visibility of pores below the surface viewed complicates the pore volume analysis.

The dimensions of the duplex pellet components in the transverse metallographic samples were measured and, along with the fuel length changes derived from neutron radiography, were used to determine the effects of porosity changes and swelling effects on the fuel volume. For the UO₂ and ZrO₂-UO₂-CaO fuels, both at compartment depletions of $\sim 6 \times 10^{20}$ f/cc, decrease in the annulus volume is observed; whereas an increase in annulus volume is indicated for the ThO₂-UO₂ fuel at compartment depletion of 9.3×10^{20} f/cc. These volume changes correlate with the preirradiation densities of the pellets as shown in Table C-19.

Table C-19. Preirradiation density and volume change of fuel materials.

Fuel Material	Preirradiation Density (%TD)	Volume Change (%)
UO ₂	95.5	-1.4
ZrO ₂ -UO ₂ -CaO	93.7	-4.7
ThO ₂ -UO ₂	96.6	+1.2

For the UO_2 and $\text{ZrO}_2\text{-UO}_2\text{-CaO}$ materials, no appreciable change in grain size from that of the unirradiated fuel was noted. For the $\text{ThO}_2\text{-UO}_2$ material, considerable difficulty was experienced in developing grain structure by chemical etching. Indistinct grain boundaries were revealed near the pellet outside diameter with size unchanged from the unirradiated size. Throughout the inner regions of the annuli, a finer microstructure without the angular shape characteristic of grains was observed. At the high depletion of this material, (18.9×10^{20} f/cc of fuel material) it appears that subdivision of grains, perhaps associated with high concentration of fission products, may be occurring. This phenomenon does not appear to have had any deleterious effects on fuel performance.

The microstructure of the ThO_2 components (central cores and spacer pellets) with maximum depletion of $\sim 0.5 \times 10^{20}$ f/cc-compartment is little different from the unirradiated material. Although there appears to be a decrease in the population of very small pores, larger pores, which constitute the bulk of the porosity, are essentially unchanged in number or size. Grain size also is unchanged from the preirradiation condition.

Investigations of the rod cladding to develop data relative to stress-corrosion cracking included:

- Metallography to assess cladding internal corrosion and fuel-cladding mechanical and chemical interaction.
- Visual examination of the inside surface of cladding.
- Examination of the inside surface of the cladding on the Scanning Electron Microscope. The cladding surface morphology of the irradiated cladding and of unirradiated cladding was studied.
- Electron Microprobe analysis of the irradiated cladding inside surface to determine the elements present and the local distribution of each.
- Chemical analysis to determine the total amount of iodine and cesium present on the cladding inside surface and inside the cladding material.
- Macroscopically, the metallographic evaluation of the cladding revealed no evidence of cracking or other defects.

Corrosion of the external cladding surface resulted in an oxide layer typically 0.04-0.08 mils (1-2 microns) thick. About 1/2 of this corrosion was present following preirradiation corrosion testing. On the internal surface of the cladding from the higher depletion rods with UO_2 and $\text{ThO}_2\text{-UO}_2$ fuel, localized patches (nodules) of corrosion, typically several microns thick and with maximum thickness of about 0.3 mil (10 microns), were observed. Visual examination of the cladding surfaces indicated these to be evenly distributed over the surface except at pellet interfaces where none were found. Electron microprobe analyses of the cladding from the UO_2 and $\text{ThO}_2\text{-UO}_2$ fueled rods indicate the corrosion nodules to be sites of concentration of uranium, thorium (if present in the fuel) and fission products. The coincidence of cladding corrosion nodules and fuel material/fission products implies a fuel transfer and fission enhancement mechanism for the formation of the corrosion. Simple rubbing of the fuel material on the cladding could be the cause.

This explanation is reinforced by observed differences in patterns of corrosion nodules on the cladding which correlate with different methods of fuel pellet grinding. The UO_2 fuel was centerless ground to diameter with the pellet simultaneously rotating and moving axially during the grinding. Corrosion nodules in the rod with UO_2 fuel were randomly distributed. The $\text{ThO}_2\text{-UO}_2$ fuel was plunge ground to diameter. In plunge grinding, the pellets do not move axially resulting in a series of minute

ridges and grooves on the pellet surface. In the rod with ThO₂-UO₂, the corrosion nodules tended to be aligned in circumferential rows. Thus, it appears that fuel material transfer to the cladding occurred at points of fuel-cladding contact.

The cladding inner surface for the rod with ZrO₂-UO₂-CaO fuel was observed metallographically to have a continuous corrosion film about 0.3 mil rather than the patchy corrosion noted in the rods with the other fuel types. Visual examination of the interior cladding surface confirmed that the corrosion film covered essentially the entire surface; in addition the examination showed a mosaic-like appearance with individual parts of the mosaic roughly equal to the size of the fragments of the cracked annulus. Electron microprobe analysis of the cladding surface indicated spatially uniform concentrations of uranium, calcium and fission products. The causes of the differing appearance of the cladding associated with the ZrO₂-UO₂-CaO fuel as compared to the cladding associated with the UO₂ and ThO₂-UO₂ fuels is not well understood.

Corrosion nodules in the UO₂ and ThO₂-UO₂ fueled rods using replicas of the cladding surfaces observed visually with a Scanning Electron Microscopy ranged from <1 mil to ~3 mils in diameter. In areas not affected by the corrosion nodules, the surface appeared very similar to the unirradiated tubing. For the ZrO₂-UO₂-CaO rod, Electron microscopy shows a structure of very closely spaced corrosion patches.

Measurements were made of the quantities of iodine and cesium on the inside surface of cladding samples from rods of the different fuel types. The UO₂ and ZrO₂-UO₂-CaO fuel rods were at depletions of $\sim 6 \times 10^{20}$ f/cc-compartment and the ThO₂-UO₂ rod was at depletion of 9.3×10^{20} f/cc-compartment. Iodine and cesium on the surface were collected by means of a rinse with dilute nitric acid. The cladding sample was then dissolved to obtain iodine and cesium that had penetrated below the surface. Concentrations of these fission products found on and in the cladding, assuming uniform distribution, are shown in Table C-20.

Table C-20. Fission product concentrations on and in the cladding.

	Concentration (mg/dm ²)	
	Iodine	Cesium
UO ₂ fueled rod 97-24	0.05	1.50
ZrO ₂ -UO ₂ -CaO fueled rod 97-39	0.05	0.85
ThO ₂ -UO ₂ fueled rod 97-17	0.08	1.10

Microprobing of the cladding surfaces indicated that in the UO₂ and ThO₂-UO₂ rods, fission products were concentrated in corrosion nodules covering about 1/2 of the surface. Thus, local concentrations of iodine and cesium for the UO₂ and ThO₂-UO₂ rods might be about twice the values given in the above summary. In the ZrO₂-UO₂-CaO fueled rod, microprobing indicated uniform distribution of fission products.

The amounts of iodine found on or in the cladding of the three rods represent 0.26–0.31% of the amount of iodine calculated to have been generated in the fuel. These releases are a factor of 4–6 below the measured release of noble fission gases from the fuel. For cesium, the release percentages range from 0.16–0.34% and are a factor of 4–11 less than the percentage release of noble fission gases.

Based on the destructive examination results for nonintentionally defected D-1 test rods, it is concluded that performance capability of the duplex fuel system is excellent. For the range of depletion covered, fission gas release was low and fuel pellet integrity was maintained with minimal dimensional changes. No effects of irradiation beyond expectations were observed.

C4.12 Irradiation Performance of Long Rod Duplex Fuel Pellet Bundle Test—LDR Test (Waldman, Sphar, and Alff 1982, WAPD-TM-1481)

This test was conducted to investigate the performance characteristics of a long column of duplex fuel, interacting with the cladding, as distinguished from earlier tests of very short lengths of duplex fuel. The test was designated The Long Duplex Rod (LDR) Test. Six rods were used for the test (97-52, 97-53, 97-54, 97-55D, 97-57, and 97-58), all are contained in the scrap canister. The rods contained duplex-fuel stacks about 67 in. in length and were operated in a test reactor with a 48-in. fuel height; this resulted in an irradiated fuel length of about 63 in. The LDR Bundle Test was irradiated in the north and southeast test loops of the ATR; these loops provided separate pressure, flow, and heat removal systems, independent of those of the ATR facility; the ATR provided the neutron environment.

Individual fuel rod characteristics are listed in the report. All the fuel rods had fuel cladding diametric gaps in the range 4.4–8.8 mils; they were operated at relatively high power levels, characterized near BOL in the range 14–16.9 kW/ft, and to high depletions, the highest being 14.2×10^{20} f/cc of compartment (28.0×10^{20} f/cc of fuel annulus volume) during normal testing. At the end of normal testing, five rods were irradiated at a power level higher than in the preceding cycle, for a period of about 27 days. Four rods experienced an increase in power in the range 40–49% and one rod 19%. None of the rods failed. All dimensional data given in the report were obtained prior to the EOL high power cycle. Properties of the cladding are the same as those given for the D-1 tests given above.

Significant variables included in the test were the following:

- Three different fuel compositions were tested as the annular portion of the duplex fuel. These compositions were UO_2 , $\text{ZrO}_2\text{-UO}_2\text{-CaO}$, and $\text{ThO}_2\text{-UO}_2$ respectively. In all cases, the central core pellet was ThO_2 .
- The duplex fuel was stacked with and without periodic full-diameter ThO_2 spacer pellets. Spacer pellets were intended to maintain axial registry between the annulus and the core.
- Both SRA and RXA zircaloy cladding were used.
- Rod internal prepressurization levels of 100 and 500 psig at room temperature were established.
- In addition, one intentionally defected rod was tested.

Based on the resulting data, the following summary observations have been made:

Compared with fuel rods with RXA cladding, fuel rods with SRA cladding experienced greater elongation and more cladding diametric shrinkage in regions where pellet-cladding interaction (PCI) was absent.

Fuel rods prepressurized to 500 psig experienced less cladding elongation and less cladding shrinkage than fuel rods prepressurized to 100 psig, within each group of the two cladding types.

No differences in performance characteristics could be assigned to any of the three fuel compositions. As evidenced by rod diameter change, the largest amount of PCI occurred with the rod having ThO₂-UO₂ fuel. This observation has no special significance, however, because this rod operated at the highest power and to the highest depletion.

No appreciable PCI occurred in rods with RXA cladding at intermediate peak depletions of 6.0×10^{20} and 7.9×10^{20} f/cc of compartment or at a high depletion of 11×10^{20} f/cc of compartment. This determination was made from axial diameter profiles.

Measurable PCI occurred in fuel rods with SRA cladding at high-peak compartment depletions of 11.7×10^{20} and 14.2×10^{20} f/cc compartment.

Of the two fuel rods which experienced the largest length change (rods with SRA cladding), the rod with the most pellet-cladding interaction, as indicated by axial diameter traces, did not show the largest length increase. The reason for this behavior may be related to two possible mechanisms acting separately or in concert; namely, (1) radial expansion of cladding would be expected to be reflected in a corresponding axial shrinkage and (2) a decrease in axial ratcheting could occur due to local locking and compartmentalization of fuel within the cladding. The latter mechanism may be enhanced by the presence of spacer pellets.

Neutron radiography showed a fuel stack length increase of 0.18% at a low peak compartment depletion of 1.1×10^{20} f/cc, indicating little or no densification in the high density, high fission rate UO₂ annular fuel.

Neutron radiographs of one fuel rod at a peak compartment depletion of 7.9×10^{20} f/cc, and a second rod at a peak compartment depletion of 11.7×10^{20} f/cc indicate no loss in the mechanical integrity of the annular fuel column; i.e., no fragmentation of the annuli. Fuel stack growth of about 0.5% was observed for these rods.

The neutron radiograph of one fuel rod identified a 0.14-in. gap in the central-core thoria-pellet stack in the upper portion of the rod, and a gap of 0.52 in. between the top of the central-core thoria-pellet stack and the top of the annular fuel stack. Based on these observations, the annular fuel stack was 0.66 in. longer than an uninterrupted central core stack. This rod was fabricated with no thoria spacer pellets and a central thoria core length 0.2 in. less than the annular fuel length to form an intentional axial gap. Comparison with an X-ray of the as-built rod revealed that the annular fuel stack had grown 0.37 in., and the central-core thoria-stack had contracted 0.09 in.

A comparison was made of cladding elongation between two groups of rods, both had SRA cladding and one operated with solid ThO₂-UO₂ pellets; the other was the LDR test with UO₂ and ThO₂-UO₂ duplex pellets. These rods all operated with similar power and fuel cladding gaps. Based on the data, less PCI-induced length change occurs with duplex fuel.

Based on fuel rod-to-fuel rod gap measurements, no significant fuel rod bowing occurred over the life of the test.

The intentionally defected rod was fabricated with a 5-mil diameter hole but experienced a water logging event that increased the diameter of the unirradiated portion of the rod; this reached a stress level near yield and caused an apparent flux-induced creep bulging in the power region.

The intentionally defected rod, which had ThO₂ spacer pellets between adjacent duplex pellets, developed hydride rims and subsequent accelerated corrosion on the external surface of the cladding at

the locations of the spacer pellets. These hydride rims were revealed in axial diameter traces and in neutron radiographs showing a typical hydride color contrast in cladding over thoria spacers. These hydride rims could result in cladding embrittlement and reduced load carrying capacity.

It is concluded that this program demonstrated satisfactory performance of the test bundle and of fuel rods containing duplex fuel pellets, which were irradiated to high fuel-annulus depletion and through a severe transient.

C4.13 Experimental Results of the Irradiation of Long Rod Duplex Pellet Screening Tests in the NRX Reactor, New Long Duplex Rod (NLDR) Test (Hoffman, Yerman and Aiff 1982, WAPD-TM-1492)

One of the designs developed by the AWBA program for a commercial-scale, prebreeder reactor core was based upon the use of fuel rods containing duplex pellets. A duplex pellet consists of a cylindrical thoria central pellet within an oxide annulus that contains fissile material. During irradiation, ^{232}Th in the central pellet is converted to ^{233}U for subsequent use in a breeder reactor core. If a UO_2 annulus is used, it can be chemically separated from the thoria central pellet following irradiation so that the ^{233}U in the central pellet is kept free of contamination by other uranium isotopes. Freedom from contamination could also be achieved by use of separate fissile and fertile fuel rods. However, reactor core power densities comparable to those of commercial cores cannot be achieved when the thorium fraction in a separate fuel rod core is high enough for efficient production of ^{233}U .

There are also a number of advantages of duplex pellets over solid pellets in both breeders and commercial reactor core applications. These advantages result mainly from the low operating fuel temperature. An irradiation test program was undertaken at Bettis to support development of duplex-pellet fuel rods. The New Long Duplex Rod (NLDR) test series (designated NLDR-1, NLDR-2, NLDR-3, and NLDR-4) was one part of this irradiation test program. The NLDR tests used six 110-in.-long, 0.3-in.-diameter Zircaloy-4 clad rods containing duplex pellets. The principal design variables are given in Table C-21. The NLDR test series was accomplished in the NRX reactor at the Chalk River Nuclear Laboratory in Chalk River, Ontario, Canada.

Table C-21. Principal design variables.

Rod ID	Test	Annular Pellet Composition	Fuel Cladding		Total Irradiation Time, EFPH
			Gap (mils)	Special Features	
97-61	NLBR-1	$\text{UO}_2\text{-ZrO}_2\text{-CaO}$	55	None	11,149
97-62	NLBR-1	UO_2	55	None	11,149
97-64	NLBR-2	$\text{ThO}_2\text{-UO}_2$	55	None	10,281
97-65	NLBR-2	UO_2	36	None	6,340
97-123	NLBR-3	UO_2	36	2 plenum springs	8,056
97-162	NLBR-4	UO_2	43	Longer central pellets	4,115

The test series was conducted to:

- Evaluate the behavior of duplex fuel pellets in long rods with pellet-cladding interaction axial loads similar to those that would be experienced by fuel rods in commercial service
- Compare the performance of UO_2 and $\text{UO}_2\text{-ZrO}_2\text{-CaO}$ duplex pellet fuel systems at power levels adjusted to reflect relative melting points
- Compare the performance UO_2 duplex fuel with a smaller cladding gap
- Compare the performance of fuel rod containing two plenum springs with fuel that has one spring
- Assess the effect of longer central thoria pellets on rod behavior.

The conclusions drawn from the testing are as follows:

- All fuel rods experienced relatively small overall external dimensional changes with irradiation up to 17.8×10^{20} f/cc compartment (about 35.6×10^{20} f/cc annulus).
- The UO_2 rod (97-64) experienced earlier fuel-cladding interaction and greater cladding length increases than the $\text{UO}_2\text{-ZrO}_2\text{-CaO}$ rod (97-61) irradiated under the same conditions.
- Beyond about $12\text{--}13 \times 10^{20}$ f/cc peak depletion, both rods experienced cladding length decreases. This phenomenon had not been previously observed in Bettis long rod tests of solid $\text{ThO}_2\text{-UO}_2$ fuel pellets irradiated in the LWBR program.
- Large gap $\text{ThO}_2\text{-UO}_2$ rod (97-64) exhibited overall length increase less than those of the large gap UO_2 rod (97-62) but greater than those noted for the large gap $\text{UO}_2\text{-ZrO}_2\text{-CaO}$ rod (97-61).
- Small gap UO_2 rod (97-65) experienced greater length increases and an earlier “turn around” in length change than large gap UO_2 rod (97-62).
- At comparable depletions, small gap UO_2 rod (97-123) with two plenum springs experienced less length increase than any other UO_2 rod in the test; some of this difference is attributed to operation at only 75–80% of design power for about 1/3 of the lifetime.
- UO_2 rod (97-162) with long central pellets experienced a greater initial length increase than any other NLDR test rod but its behavior at intermediate depletions was typical of the other UO_2 rods in the test.
- Closure of both the fuel-to-cladding and annulus-to-central pellet gaps resulted in significant cladding diameter increases due to continued radial swelling of the fuel. This phenomenon was observed in all three fuel systems.

C4.14 In-Pile and Out-of-Pile Corrosion Behavior of Thoria-Urania Pellets (Clayton 1987a, WAPD-TM-1548)

A total of 19 LWBR irradiation test rods from 14 irradiation tests (summarized in the report) composed the database for the in-pile portion of the fuel stability study. Nine of the rods are contained in

the scrap canister (79-301D, 79-307D, 79-322D, 79-433D, 79-441D, 79-504D, 79-583D, 79-609D, and 79-614D). The 19 fuel rods contained ThO₂, ThO₂/²³⁵UO₂, and ThO₂/²³³UO₂ fuel pellets. The rods (14 seed and 5 blanket) were intentionally defected with drilled holes prior to testing. A larger (~0.089-cm diameter) spotting hole was first drilled halfway through the Zircaloy-4 cladding from the outside surface and then continued through the wall to the inside surface with a smaller 5-mil diameter (~0.013-cm diameter) defect hole. Irradiation histories of the 19 defected rods are given; irradiation exposures were up to 19,970 EFPH with peak fluences (>1 Mev) of up to 98×10^{20} n/cm². The coolant for these irradiation tests was pressurized water maintained at pH 10 by NH₄OH addition. Coolant oxygen, hydrogen, and chlorine concentrations were <0.14 ppm, 40-70 cc/kg, and <0.1 ppm, respectively. The irradiation tests were performed in the ETR, the ATR and the NRX. A summary of the in-pile testing results follows.

- Satisfactory fuel performance was demonstrated in the ThO₂ and ThO₂-UO₂ fueled defected LWBR test rods irradiated to peak depletions up to 12×10^{20} f/cc and peak fast neutron (>1 Mev) fluences up to 98×10^{20} neutron/cm².
- Excellent fuel chemical, mechanical, and thermal behavior was shown for operating conditions up to peak linear power levels of 518 w/cm, peak heat fluxes up to 189 w/cm², and peak center temperatures up to 2366K.
- No evidence of significant corrosion or erosion of the fuel pellets was observed. Nine of the 19 intentionally defected rods displayed some minor indications of corrosion-erosion; white or gray streaks or spots manifested this just around or downstream from the defect hole openings. These effects were only observed in the area around the defect and were most likely the result of a limited amount of fuel, fission product, or contaminated zircaloy corrosion locally downstream of the hole.
- No other indications of fuel corrosion-erosion were detected. The ThO₂ and ThO₂-UO₂ fuel pellets, when compared with previous in-pile tests on UO₂ and ZrO₂-UO₂ fuels, had lower levels of released activity, slower fission product leaching, and minimal fuel solution and attrition by the coolant.

No fuel grain growth was detected but there was some migration of porosity to the grain boundaries. Fuel cracking occurred as would be expected for long-term operation of both defected and nondefected fuel rods. No evidence of fuel waterlogging was observed. (Waterlogging is deformation of the cladding caused by excessive internal fuel rod pressure of entrapped coolant as it flashes to steam during a power increase).

The conclusions drawn from the testing are as follows:

- Both ThO₂ and homogeneous ThO₂-UO₂ (2-30 w/o UO₂) fuel pellets have excellent corrosion resistance - even in oxygenated, high temperature, pressurized water.
- Thoria-urania is one of the most corrosion resistant of all UO₂ solid solution oxide fuels. Even when oxidative attack does occur, the mode of oxidation, growth of a second cubic phase, permits the ThO₂-UO₂ samples to maintain their integrity.
- Maintenance of fuel integrity in defected irradiation test rods was consistent with the favorable stability of out-of-pile corrosion tests on thoria-base fuel pellets.

- Under the defect condition of exposure to high temperature water containing an oxidant (H_2O_2 or O_2 from fission fragment radiolysis of the water coolant), thoria-base fuels exhibit: (1) slower fission product leaching, (2) lower levels of released activity, and (3) slower fuel solution and attrition by the coolant than is the case for UO_2 and $\text{ZrO}_2\text{-UO}_2$ fuel systems.
- Both the in-pile and out-of-pile test results support the conclusion that LWBR-type fuel rods containing ThO_2 and $\text{ThO}_2\text{-UO}_2$ pellets can successfully operate in the defect condition with limited radioactivity release to the coolant.

C4.15 Internal Hydriding in Irradiated Defected Zircaloy Fuel Rods—A Review (Clayton 1987b, WAPD-TM-1604)

The review summarizes the test data, causes, mechanism, and methods of minimizing internal hydriding failures in defected zircaloy-clad fuel rods. A defect is defined as a breach of cladding integrity, i.e., a perforation (slit, crack, or pinhole) that leaks fission products to the coolant and coolant to the rod internals. Many defected zircaloy-clad fuel rods operated satisfactorily without diminishing core performance. A fuel rod failure is defined as loss of cladding integrity, high coolant activity level, and contamination of the coolant by particulate fuel.

Two types of hydriding, external hydriding produced by hydrogen outside the fuel rod and internal hydriding due to reactions inside the fuel rod, were identified in zircaloy-clad fuel rods. Internal hydriding is further classified as primary or secondary hydriding. Primary hydriding is generated internally in an initially nondefected zircaloy fuel rod. Its sources are hydrogenous contaminants (moisture, oil, grease, etc.) introduced into the fuel rod during fabrication as well as any residual hydrogen in the oxide fuel resulting from the hydrogen sintering operation. In secondary hydriding the initial breach of the zircaloy cladding is caused either by primary hydriding itself or by a nonhydride-related incident that allows coolant to enter and hydride the rod. Examples of a nonhydriding incident include stress-corrosion cracking induced by pellet-cladding interaction, power ramp, aggressive fission product attack, rod-to-rod contact causing high cladding temperatures, cladding wear at support grid contact points, etc. The report reviewed the problem of secondary hydriding, mainly in pressurized water reactors where the coolant contains some dissolved hydrogen.

Hydrogen pickup in zircaloy fuel rods falls into three categories: expected due to corrosion, accelerated, and massive. Expected hydrogen pickup results from the additional hydrogen that enters the zircaloy cladding through the ZrO_2 corrosion film (about 50–500 ppm). Accelerated hydriding is defined as hydrogen absorption from the coolant far in excess of the nominal 25% pickup fraction of free H_2 produced by the $\text{Zr-H}_2\text{O}$ corrosion reaction for Zircaloy-4 (several thousand ppm). Massive hydriding is the formation of regions of delta phase zirconium hydride in the cladding due to grossly accelerated hydrogen pickup (16,300 ppm). At operating temperatures for PWRs, zirconium is thermodynamically unstable with respect to hydrogen and should completely hydride. The protective corrosion oxide surface film prevents the gaseous hydrogen in the coolant from reacting with the bare zircaloy.

As part of the review intentionally defected rods from pre-LWBR tests, the LWBR (19 fuel rods—identification numbers of the rods in the scrap canister are given above), and the AWBA programs (3 fuel rods—97-36D is in the scrap canister) were analyzed.

C4.15.1 Pre-LWBR Tests

The Bettis Laboratory was one of the first to study the behavior of defected zircaloy-clad UO_2 fuel rods in-pile and the factors affecting the limit of their performance. The initial work was carried out in the 1950s in support of the Shippingport PWR Core I blanket rods. Excessive cladding hydriding was observed in both intentionally defected rods and in rods that operationally defected in-pile (unintentionally defected). Hydrogen contents of 100–200 ppm were found in cladding near defects and 1400 ppm at the ends of the rods. Either the intentionally fabricated defect holes of some rods became plugged or the areas of the rod away from the defect hole became effectively isolated and behaved as though the rods were not defected. In any case, the cladding of these rods became stressed and ruptured during irradiation with resultant hydriding.

Since 1960, massive internal hydriding was found only in rods that operationally defected in-pile. Sixteen such in-pile defected rods were observed. Fuel compositions were mainly UO_2 , $\text{ZrO}_2\text{-UO}_2$ and $\text{UO}_2\text{-ZrO}_2\text{-CaO}$. Irradiation periods in the defected state after cladding rupture varied from about five minutes to approximately 200 days. Cladding cracking, both ductile and brittle, was attributed to bad welds, burnout caused by molten fuel, cladding instability due to fuel swelling, and water logging. All 16 rods were destructively examined, and extensive areas of massive internal hydride were detected in 13 of them. Both accelerated and massive hydriding occurred at remote locations from the defect. Two of the remaining rods were found to have brittle cladding fractures. Hydride was observed mainly in the cladding near the end caps. The cladding over the fuel stacks was relatively free of hydride. The last rod waterlogged and displayed only an overall high hydrogen content in the cladding (about 300 ppm) but did not exhibit massive hydriding.

Thirty intentionally fabricated defected rods were tested between 1960–1970. These rods were fabricated with various pellet geometries (annular, dished-end, solid), pellet densities (84–98% theoretical), and fuel materials (UO_2 , $\text{ZrO}_2\text{-UO}_2$, $\text{ThO}_2\text{-UO}_2$). The irradiation performance of these intentionally defected rods was satisfactory. Postirradiation fuel structures ranged from that of the preirradiation structures to almost total fuel melting.

Three cases of water logging occurred in these intentionally fabricated defected rods. Cladding diameter swelling was measured in a UO_2 -fuel and a $\text{ZrO}_2\text{-UO}_2$ fuel rod. Another $\text{ZrO}_2\text{-UO}_2$ fuel rod ruptured resulting in cladding hydrogen concentrations of about 500 ppm, but massive internal hydriding was not found. This failure was attributed to excessive plastic straining caused by repeated water logging incidents during irradiation. With the exception of the ruptured rod, there were no detectable fuel losses associated with the irradiation of these 30 intentionally defected fuel rods.

Six of these intentionally defected rods contained $\text{ThO}_2\text{-UO}_2$ fuel. There were no unusual incidents during the irradiation of these rods indicating satisfactory performance.

The pre-LWBR test data can be summarized as follows:

- Fuel rods with intentionally fabricated defects generally did not excessively hydride.
- Fuel rods that defected in-pile generally had areas of accelerated or massive hydriding.

C4.15.2 LWBR Tests

The Shippingport LWBR core contained 12 hexagonal-shaped modules that were arranged in a symmetric array surrounded by 15 reflector modules. Each of the hexagonal fuel modules contained a central movable seed assembly surrounded by a stationary blanket assembly. The fuel was ThO_2 and

ThO₂-UO₂ pellets that were sealed in Zircaloy-4 tubes. The absence of higher-than-expected coolant activity during operation indicated that there was no detectable breach of the cladding in any of the LWBR rods.

As part of the LWBR irradiation test program, 19 fuel rods (14 seed and 5 blanket) were intentionally defected with drilled holes (0.005-in. diameter) prior to testing. In addition, two blanket test rods developed small cladding defects during planned in-service transient testing. The transient testing was at higher heating rates than occurred during LWBR reactor operations.

All 21 defected test rods operated successfully with limited radioactivity release to the coolant. No significant ThO₂ or ThO₂-UO₂ fuel erosion was detected. Because of the greater internal surface corrosion, the total hydrogen content in the defected rod cladding was several times those in nondefected rod cladding with similar irradiation histories 100–500 ppm compared to 30–70 ppm hydrogen. A pronounced variation in hydride concentration was observed through the cladding wall thickness of the defected rods. Hydrogen levels in the cladding were higher at the external surface than at the internal surface because hydrogen diffuses toward the cooler region in a sufficiently high thermal gradient. The hydride concentrations for nondefected rod cladding were relatively uniform.

Hydrides in the vicinity of the defect hole were generally low in concentration with typical uniform levels of about 100 ppm. This might occur from hydrogen escaping through the defect hole resulting in a low H₂/H₂O ratio or hydrogen diffusion to adjacent cooler cladding areas. Evidence of hydrogen migration to cooler regions of the rods remote from the defect hole was observed, indicating that local hydrogen levels are not always proportional to corrosion oxide thickness in defected rods.

Instances of localized accelerated and massive hydriding were detected in three intentionally defected and one operationally defected fuel rod. None of these incidents interfered with the operation of the irradiation tests. For example, one rod that defected in service due to iodine stress corrosion cracking operated successfully for about 12,000 EFPH. This rod was operational even though during postirradiation examination the cladding was observed to be massively hydrided near the bottom end of the rod. None of these hydrided rods lost structural integrity during operation, which attests to their ability to function under localized and massive hydriding conditions.

C4.15.3 AWBA Tests

The AWBA program used a duplex pellet concept. The duplex pellet design consisted of a cylindrical thorium central core inside an oxide annulus that contained the initial fissile material. Transmutation of the thorium in the duplex pellet to ²³³U provides fuel for use in subsequent breeders. The irradiation test program supporting development of the duplex fuel pellet included three intentionally fabricated defected rods, two with UO₂ and one with ThO₂-UO₂ annuli.

Some slight erosion was noted in the UO₂ fueled defected rod. The irradiation performance of the ThO₂-UO₂ fueled defected rod compared favorably with that of the LWBR solid ThO₂-UO₂ pellet irradiation tests. Circumferential white corrosion rings were observed on the outside cladding surface of the defected rod with the ThO₂-UO₂ annulus at the locations of 50-mil-thick ThO₂ spacers separating the duplex pellets in the fuel stack. Neutron radiography and metallographic examination of the cladding showed that the white corrosion rings were associated with substantial nonuniform concentrations of hydrogen in the cladding, with the regions affected by the corrosion rings coinciding with the regions of heaviest hydrogen concentration. In regions of cladding adjacent to the ThO₂-UO₂ annulus, hydrogen concentrations ranged from <100 ppm near the inner surface to several hundred ppm or more near the outer surface. In the cooler cladding adjacent to ThO₂ spacer pellets, much higher concentrations of hydrogen were observed. These concentrations varied from about 500 ppm near the inner surface to

approximately 12,000 ppm in a rim about 3 to 5 mils thick at the outer surface. The fuel stack arrangement in this rod, consisting of pellets containing the fissile material (with high power and heat generation) interspersed with the ThO₂ spacers (with lower power and heat output), generated hydrogen cold traps in the cladding.

Diameter measurements revealed ridging of the cladding at the locations of the white corrosion rings. The average diametric ridge height was 0.8 mil with a maximum of 1.2 mils. This ridging could be caused by the volumetric increases associated with the extensive hydriding. Subsequent development of the accelerated white corrosion rings then resulted from disturbances in the protective corrosion film due to local straining and/or reduced corrosion resistance of zirconium hydride.

A summary of the review follows:

- Intentionally defected zircaloy test rods usually do not excessively hydride.
- Zircaloy fuel rods that defect in service generally acquire localized areas of accelerated or massive hydride.
- Both intentionally and operationally defected fuel rods with local areas of accelerated and massive zirconium hydride can operate without failure for extended periods of time under restricted power conditions.
- Out-of-pile zirconium hydriding test data in H₂/H₂O gas mixtures shows that specimen characteristics (geometry and surface conditions) as well as environmental factors (hydrogen pressure, test temperature, and test time) affect the amount of hydrogen pickup in zircaloy. In addition, the type of zircaloy (2 or 4), the heat treatment, and minor variations in the alloying conditions were also found to influence hydrogen absorption.
- The significant factors affecting internal hydriding in defected zircaloy rods are defect size, sources of hydrogen, zircaloy cladding inside surface properties, aggressive fission product attack on inner oxide film, nickel alloy contamination of zircaloy, and the effects of heat flux and fluence.
- Pertinent in-pile and out-of-pile test data and the significant factors affecting internal hydriding in defected zircaloy fuel rods are used as a data base in constructing a descriptive model which explains hydrogen distribution in zircaloy cladding of defected water-cooled reactor fuel rods.
- Methods for minimizing secondary hydride failures in defected zircaloy fuel rods include control of hydride orientation, protective coatings, hydrogen getters, and power operating restrictions.

C5. REFERENCES

Belle, J., and R. M. Berman, 1978, *Properties of Thoria and Thoria-Urania: A Review*, (LWBR Development Program), WAPD-TM-1340, June 1978.

Clayton, J. C., 1982, *Corrosion and Hydriding of Irradiated Zircaloy Fuel Rod Cladding*, (LWBR Development Program), WAPD-TM-1440, September 1982.

Clayton, J. C., 1985, *Cladding Corrosion and Hydriding in Irradiated Defected Zircaloy Fuel Rods*, (LWBR Development Program), WAPD-TM-1393, August 1985.

- Clayton, J. C., 1987a, *In-Pile and Out-of-Pile Corrosion Behavior of Thoria-Urania Pellets*, (LWBR Development Program), WAPD-TM-1548, January 1987.
- Clayton, J. C., 1987b, *Internal Hydriding in Irradiated Defected Zircaloy Fuel Rods—a Review*, (LWBR Development Program), WAPD-TM-1604, October 1987.
- Daniel, R. C., 1970, *In-Pile Dimensional Changes of Zircaloy-4 Tubing Having Low Hoop Stresses*, (LWBR Development Program), WAPD-TM-973, July 1970.
- Duncombe, E. and I. Goldberg, 1970, *Comparison of Dimensional Changes in Fuel Rods with Predictions under Cyclic conditions of Power and System Pressure*, (LWBR Development Program), WAPD-TM-940, March 1970.
- Giovengo, J. F., I. Goldberg, and C. D. Sphar, 1978, *Fission Gas Release From High burnup ThO_2 and ThO_2-UO_2 Fuels Irradiated at Low Temperature*, (LWBR Development Program), WAPD-TM-1350ADD2, August 1978.
- Giovengo, J. F., 1970, *In-Pile Dimensional Changes of ThO_2-UO_2 Fuel Rods with Non-Free-Standing Cladding*, (LWBR Development Program), WAPD-TM-986, November 1970.
- Goldberg, I., 1969, *A Procedure for Calculation of Stead-State Temperature in Zircaloy-Clad Bulk Oxide Fuel Elements Using the FIGRO Computer Program*, WAPD-TM-757, November 1969.
- Goldberg, I., et al., 1979, *Fission Gas Release and Grain Growth in ThO_2 and ThO_2-UO_2 Fuel Irradiated at High Temperature*, (LWBR Development Program), WAPD-TM-1350ADD, July 1979.
- Goldberg, I., et al., 1982, *Fission Gas Release From ThO_2 and ThO_2-UO_2 Fuels*, (LWBR Development Program), WAPD-TM-1350, May 1982.
- Hoffman, R. C., and J. Sherman, 1978, *Irradiation Testing of Internally Pressurized and/or Graphite Coated Zircaloy-4 clad Fuel Rods in the NRX Reactor*, (AWBA Development Program), WAPD-TM-1376, November 1978.
- Hoffman, R. C., J. F. Yerman, and T. H. Alff, 1982, *Experimental Results of the Irradiation of Long Rod Duplex Pellet Screening Test in the NRX Reactor (NLDR-1 Test)*, (AWBA Development Program), WAPD-TM-1492, July 1982.
- Ivak, D. M. and L. A. Waldman, 1979, *Iodine and Cesium in Oxide Fuel Pellets and Zircaloy-4 Cladding of Irradiated Fuel Rods*, (LWBR Development Program), WAPD-TM-1394, March 1979.
- Newman, J. B., J. F. Giovengo, and L. P. Comden, 1977, *The CYGRO-4 Fuel Rod Analysis Computer Program*, WAPD-TM-1300, July 1977.
- Pruss, C. A., 1987, *ICPP Fuel Receipt Criteria for LWBR Core and Irradiation Test Fuel*, WAPD-NRF(L)D-96, August 10, 1987 and W. J. Babyak, *Revised Response to ICPP Fuel Receipt Criteria, Parts A and B, for the LWBR Irradiation Test Fuel*, WAPD-NRF(L)D-110, September 23, 1987.
- Sphar, C. D., and J. Sherman, 1979, *Early-in-life Performance of Short Rod Duplex Pellet Screening (D-1) Test*, WAPD-TM-1378, November 1979.

- Sphar, C. D., D. A. Mertz, and W. S. Roesener, 1982, *Irradiation Performance of Duplex Fuel Pellet Test Rods Depleted to 9×10^{20} Fissions/cm³ of Compartment—D-1 Test*, (AWBA Development Program), WAPD-TM-1460, January 1982.
- Stackhouse, R. M., ed., 1979, *Fuel Rod-Grid Interaction Wear: In-Reactor Tests*, (LWBR Development Program), WAPD-TM-1347, November 1979.
- Waldman, L. A., C. D. Sphar, and T. H. Alff, 1982, *Irradiation Performance of Long Rod Duplex Fuel Pellet Bundle Test—LDR Test*, (AWBA Development Program), WAPD-TM-1481, April 1982.
- Warner, H. R., 1969, *Release of Fission Gases from Oxide Fuels*, (LWBR Development Program), WAPD-TM-805, July 1969.

Appendix D
Rods in the Type C Storage Liners

Appendix D

Rods in the Type C Storage Liners

The rod serial numbers and end-of-life isotopic contents are presented below, sorted first by liner number then by liner cell. The liner cell numbers correspond to Figures 6-17 through 6-23. The first two digits of the rod serial numbers for the seed and blanket rods indicate the rod type.

The data in the tables are end-of-life isotopic data based on modeling done before the time of shipment. These data were extracted from tables attached to the Part B Fuel Receipt Criteria for the Type C (loose rod) storage liners. These data are presented here for convenience. Refer to the original documentation to confirm the accuracy of transcription.

Liner Cell	Rod Number	Liner Number	Assembly Number	Liner no.	POB Category	Th-232 (kg)	U-232 (g)	U-233 (g)	U-234 (g)	U-235 (g)	U-238 (g)
101	3120818	15681	L-RA01-10	R 4-3	43	6.09	0.00	4.54	0.03	0.00	0.00
102	3116829	15681	L-RA01-10	R 4-3	47	6.04	0.04	30.97	1.12	0.09	0.00
103	3225352	15681	L-RA01-10	R 4-3	44	6.09	0.00	9.36	0.10	0.00	0.00
104	3214013	15681	L-RA01-10	R 4-3	45	6.08	0.01	15.31	0.28	0.01	0.00
105	3206266	15681	L-RA01-10	R 4-3	46	6.08	0.02	22.42	0.59	0.04	0.00
144	3116443	15681	L-RA01-09	R 4-4	40	6.08	0.01	16.57	0.32	0.01	0.00
145	3122403	15681	L-RA01-09	R 4-4	41	6.07	0.02	23.53	0.65	0.04	0.00
146	3116508	15681	L-RA01-09	R 4-4	41	6.07	0.02	23.53	0.65	0.04	0.00
147	3116755	15681	L-RA01-09	R 4-4	41	6.07	0.02	23.53	0.65	0.04	0.00
148	3124547	15681	L-RA01-09	R 4-4	42	6.04	0.04	32.39	1.22	0.10	0.00
149	3121009	15681	L-RA01-09	R 4-4	42	6.04	0.04	32.39	1.22	0.10	0.00
150	3215104	15681	L-RA01-09	R 4-4	40	6.08	0.01	16.57	0.32	0.01	0.00
151	3224665	15681	L-RA01-09	R 4-4	40	6.08	0.01	16.57	0.32	0.01	0.00
152	3202216	15681	L-RA01-09	R 4-4	40	6.08	0.01	16.57	0.32	0.01	0.00
153	3203233	15681	L-RA01-09	R 4-4	40	6.08	0.01	16.57	0.32	0.01	0.00
154	3202243	15681	L-RA01-09	R 4-4	41	6.07	0.02	23.53	0.65	0.04	0.00
155	3200346	15681	L-RA01-09	R 4-4	41	6.07	0.02	23.53	0.65	0.04	0.00
156	3207568	15681	L-RA01-09	R 4-4	42	6.04	0.04	32.39	1.22	0.10	0.00
157	3207357	15681	L-RA01-09	R 4-4	42	6.04	0.04	32.39	1.22	0.10	0.00
158	3116553	15681	L-RA01-09	R 4-4	41	6.07	0.02	23.53	0.65	0.04	0.00
159	3118000	15681	L-RA01-09	R 4-4	41	6.07	0.02	23.53	0.65	0.04	0.00
160	3107486	15681	L-RA01-09	R 4-4	41	6.07	0.02	23.53	0.65	0.04	0.00
161	3117377	15681	L-RA01-09	R 4-4	41	6.07	0.02	23.53	0.65	0.04	0.00
162	3116865	15681	L-RA01-09	R 4-4	41	6.07	0.02	23.53	0.65	0.04	0.00
163	3123401	15681	L-RA01-09	R 4-4	42	6.04	0.04	32.39	1.22	0.10	0.00
164	3104572	15681	L-RA01-09	R 4-4	42	6.04	0.04	32.39	1.22	0.10	0.00

D-4

Liner Cell	Rod Number	Liner Number	Assembly Number	Liner no.	POB Category	Th-232 (kg)	U-232 (g)	U-233 (g)	U-234 (g)	U-235 (g)	U-238 (g)
165	3207027	15681	L-RA01-09	R 4-4	40	6.08	0.01	16.57	0.32	0.01	0.00
166	3204680	15681	L-RA01-09	R 4-4	41	6.07	0.02	23.53	0.65	0.04	0.00
167	3204764	15681	L-RA01-09	R 4-4	41	6.07	0.02	23.53	0.65	0.04	0.00
168	3205507	15681	L-RA01-09	R 4-4	41	6.07	0.02	23.53	0.65	0.04	0.00
169	3220265	15681	L-RA01-09	R 4-4	41	6.07	0.02	23.53	0.65	0.04	0.00
170	3206578	15681	L-RA01-09	R 4-4	41	6.07	0.02	23.53	0.65	0.04	0.00
171	3206367	15681	L-RA01-09	R 4-4	42	6.04	0.04	32.39	1.22	0.10	0.00
172	3214884	15681	L-RA01-09	R 4-4	42	6.04	0.04	32.39	1.22	0.10	0.00
173	3216873	15681	L-RA01-09	R 4-4	42	6.04	0.04	32.39	1.22	0.10	0.00
174	3108779	15681	L-RA01-09	R 4-4	42	6.04	0.04	32.39	1.22	0.10	0.00
175	3107203	15681	L-RA01-09	R 4-4	42	6.04	0.04	32.39	1.22	0.10	0.00
176	3102419	15681	L-RA01-09	R 4-4	42	6.04	0.04	32.39	1.22	0.10	0.00
177	3122834	15681	L-RA01-09	R 4-4	42	6.04	0.04	32.39	1.22	0.10	0.00
178	3118880	15681	L-RA01-09	R 4-4	42	6.04	0.04	32.39	1.22	0.10	0.00
179	3122356	15681	L-RA01-09	R 4-4	42	6.04	0.04	32.39	1.22	0.10	0.00
180	3217322	15681	L-RA01-09	R 4-4	42	6.04	0.04	32.39	1.22	0.10	0.00
181	3101815	15681	L-RA01-08	R 5-4	50	6.07	0.01	19.14	0.42	0.02	0.00
182	3102354	15681	L-RA01-08	R 5-4	49	6.09	0.00	10.46	0.12	0.00	0.00
183	3210127	15681	L-RA01-08	R 5-4	48	6.09	0.00	4.80	0.03	0.00	0.00
184	3125500	15681	L-RA01-03	R 4-9	39	6.09	0.00	10.34	0.13	0.00	0.00
185	3121615	15681	L-RA01-03	R 4-9	38	6.09	0.00	4.99	0.03	0.00	0.00
186	3222768	15681	L-RA01-03	R 4-9	38	6.09	0.00	4.99	0.03	0.00	0.00
187	3220650	15681	L-RA01-03	R 4-9	40	6.08	0.01	16.57	0.32	0.01	0.00
188	3202032	15681	L-RA01-03	R 4-9	39	6.09	0.00	10.34	0.13	0.00	0.00
189	3126177	15681	L-RA01-03	R 4-9	42	6.04	0.04	32.39	1.22	0.10	0.00
190	3122521	15681	L-RA01-03	R 4-9	41	6.07	0.02	23.53	0.65	0.04	0.00

Liner Cell	Rod Number	Liner Number	Assembly Number	Liner no.	POB Category	Th-232 (kg)	U-232 (g)	U-233 (g)	U-234 (g)	U-235 (g)	U-238 (g)
191	3126186	15681	L-RA01-03	R 4-9	38	6.09	0.00	4.99	0.03	0.00	0.00
601	3224023	15681	L-RA01-10	R 4-3	43	6.09	0.00	4.54	0.03	0.00	0.00
602	3214250	15681	L-RA01-10	R 4-3	43	6.09	0.00	4.54	0.03	0.00	0.00
603	3225085	15681	L-RA01-10	R 4-3	44	6.09	0.00	9.36	0.10	0.00	0.00
604	3222566	15681	L-RA01-10	R 4-3	43	6.09	0.00	4.54	0.03	0.00	0.00
605	3102015	15681	L-RB01-08	R 5-4	50	6.07	0.01	19.14	0.42	0.02	0.00
606	3105315	15681	L-RB01-08	R 5-4	49	6.09	0.00	10.46	0.12	0.00	0.00
607	3105167	15681	L-RB01-08	R 5-4	49	6.09	0.00	10.46	0.12	0.00	0.00
609	3113336	15681	L-RB01-08	R 5-4	48	6.09	0.00	4.80	0.03	0.00	0.00
610	3122879	15681	L-RA01-10	R 4-3	46	6.08	0.02	22.42	0.59	0.04	0.00
611	3114326	15681	L-RA01-10	R 4-3	47	6.04	0.04	30.97	1.12	0.09	0.00
612	3114804	15681	L-RA01-10	R 4-3	46	6.08	0.02	22.42	0.59	0.04	0.00
613	3111504	15681	L-RA01-10	R 4-3	45	6.08	0.01	15.31	0.28	0.01	0.00
614	3112815	15681	L-RA01-10	R 4-3	45	6.08	0.01	15.31	0.28	0.01	0.00
615	3120156	15681	L-RA01-10	R 4-3	45	6.08	0.01	15.31	0.28	0.01	0.00
616	3223188	15681	L-RA01-10	R 4-3	44	6.09	0.00	9.36	0.10	0.00	0.00
617	3213858	15681	L-RA01-10	R 4-3	44	6.09	0.00	9.36	0.10	0.00	0.00
618	3201776	15681	L-RA01-10	R 4-3	45	6.08	0.01	15.31	0.28	0.01	0.00
619	3211429	15681	L-RA01-10	R 4-3	45	6.08	0.01	15.31	0.28	0.01	0.00
620	3126022	15681	L-RA01-10	R 4-3	47	6.04	0.04	30.97	1.12	0.09	0.00
621	3126159	15681	L-RA01-10	R 4-3	43	6.09	0.00	4.54	0.03	0.00	0.00
622	3211034	15681	L-RA01-10	R 4-3	45	6.08	0.01	15.31	0.28	0.01	0.00
623	3208834	15681	L-RA01-10	R 4-3	46	6.08	0.02	22.42	0.59	0.04	0.00
624	3117709	15681	L-RA01-10	R 4-3	44	6.09	0.00	9.36	0.10	0.00	0.00
625	3115580	15681	L-RA01-10	R 4-3	44	6.09	0.00	9.36	0.10	0.00	0.00
626	3117560	15681	L-RA01-10	R 4-3	43	6.09	0.00	4.54	0.03	0.00	0.00

Liner Cell	Rod Number	Liner Number	Assembly Number	Liner no.	POB Category	Th-232 (kg)	U-232 (g)	U-233 (g)	U-234 (g)	U-235 (g)	U-238 (g)
627	3102583	15681	L-RA01-10	R 4-3	43	6.09	0.00	4.54	0.03	0.00	0.00
628	3122513	15681	L-RA01-03	R 4-9	40	6.08	0.01	16.57	0.32	0.01	0.00
629	3120165	15681	L-RA01-03	R 4-9	41	6.07	0.02	23.53	0.65	0.04	0.00
630	3104417	15681	L-RA01-03	R 4-9	38	6.09	0.00	4.99	0.03	0.00	0.00
631	3121173	15681	L-RA01-03	R 4-9	38	6.09	0.00	4.99	0.03	0.00	0.00
632	3121476	15681	L-RA01-03	R 4-9	38	6.09	0.00	4.99	0.03	0.00	0.00
633	3124886	15681	L-RA01-03	R 4-9	38	6.09	0.00	4.99	0.03	0.00	0.00
634	3224683	15681	L-RA01-03	R 4-9	38	6.09	0.00	4.99	0.03	0.00	0.00
635	3226176	15681	L-RA01-03	R 4-9	38	6.09	0.00	4.99	0.03	0.00	0.00
636	3218540	15681	L-RA01-03	R 4-9	38	6.09	0.00	4.99	0.03	0.00	0.00
637	3224748	15681	L-RA01-03	R 4-9	39	6.09	0.00	10.34	0.13	0.00	0.00
638	3222815	15681	L-RA01-03	R 4-9	38	6.09	0.00	4.99	0.03	0.00	0.00
639	3211135	15681	L-RA01-03	R 4-9	39	6.09	0.00	10.34	0.13	0.00	0.00
640	3202757	15681	L-RA01-03	R 4-9	39	6.09	0.00	10.34	0.13	0.00	0.00
641	3218743	15681	L-RA01-03	R 4-9	39	6.09	0.00	10.34	0.13	0.00	0.00
642	3222667	15681	L-RA01-03	R 4-9	38	6.09	0.00	4.99	0.03	0.00	0.00
643	3221530	15681	L-RA01-03	R 4-9	38	6.09	0.00	4.99	0.03	0.00	0.00
644	3223529	15681	L-RA01-03	R 4-9	38	6.09	0.00	4.99	0.03	0.00	0.00
645	3120376	15681	L-RA01-03	R 4-9	42	6.04	0.04	32.39	1.22	0.10	0.00
646	3123474	15681	L-RA01-03	R 4-9	40	6.08	0.01	16.57	0.32	0.01	0.00
647	3123263	15681	L-RA01-03	R 4-9	41	6.07	0.02	23.53	0.65	0.04	0.00
648	3125389	15681	L-RA01-03	R 4-9	39	6.09	0.00	10.34	0.13	0.00	0.00
649	3125005	15681	L-RA01-03	R 4-9	38	6.09	0.00	4.99	0.03	0.00	0.00
650	3111448	15681	L-RA01-03	R 4-9	40	6.08	0.01	16.57	0.32	0.01	0.00
651	3124805	15681	L-RA01-03	R 4-9	38	6.09	0.00	4.99	0.03	0.00	0.00
652	3100282	15681	L-RA01-03	R 4-9	42	6.04	0.04	32.39	1.22	0.10	0.00

Liner Cell	Rod Number	Liner Number	Assembly Number	Liner no.	POB Category	Th-232 (kg)	U-232 (g)	U-233 (g)	U-234 (g)	U-235 (g)	U-238 (g)
653	3118836	15681	L-RA01-03	R 4-9	42	6.04	0.04	32.39	1.22	0.10	0.00
654	3123135	15681	L-RA01-03	R 4-9	40	6.08	0.01	16.57	0.32	0.01	0.00
655	3123236	15681	L-RA01-03	R 4-9	42	6.04	0.04	32.39	1.22	0.10	0.00
656	3220404	15681	L-RA01-03	R 4-9	41	6.07	0.02	23.53	0.65	0.04	0.00
657	3221659	15681	L-RA01-03	R 4-9	40	6.08	0.01	16.57	0.32	0.01	0.00
658	3221448	15681	L-RA01-03	R 4-9	40	6.08	0.01	16.57	0.32	0.01	0.00
659	3218844	15681	L-RA01-03	R 4-9	39	6.09	0.00	10.34	0.13	0.00	0.00
660	3124556	15681	L-RA01-03	R 4-9	38	6.09	0.00	4.99	0.03	0.00	0.00
661	3121586	15681	L-RA01-03	R 4-9	39	6.09	0.00	10.34	0.13	0.00	0.00
662	3121265	15681	L-RA01-03	R 4-9	38	6.09	0.00	4.99	0.03	0.00	0.00
663	3126140	15681	L-RA01-03	R 4-9	39	6.09	0.00	10.34	0.13	0.00	0.00
664	3224739	15681	L-RA01-03	R 4-9	39	6.09	0.00	10.34	0.13	0.00	0.00
665	3215048	15681	L-RA01-03	R 4-9	38	6.09	0.00	4.99	0.03	0.00	0.00
666	3220229	15681	L-RA01-03	R 4-9	38	6.09	0.00	4.99	0.03	0.00	0.00
667	3207256	15681	L-RA01-03	R 4-9	38	6.09	0.00	4.99	0.03	0.00	0.00
668	3222135	15681	L-RA01-03	R 4-9	39	6.09	0.00	10.34	0.13	0.00	0.00
669	3225783	15681	L-RA01-03	R 4-9	39	6.09	0.00	10.34	0.13	0.00	0.00
670	3223152	15681	L-RA01-03	R 4-9	39	6.09	0.00	10.34	0.13	0.00	0.00
671	3223050	15681	L-RA01-03	R 4-9	38	6.09	0.00	4.99	0.03	0.00	0.00
672	3224564	15681	L-RA01-03	R 4-9	39	6.09	0.00	10.34	0.13	0.00	0.00
673	3206542	15681	L-RA01-03	R 4-9	42	6.04	0.04	32.39	1.22	0.10	0.00
674	3221062	15681	L-RA01-03	R 4-9	41	6.07	0.02	23.53	0.65	0.04	0.00
675	3218577	15681	L-RA01-03	R 4-9	41	6.07	0.02	23.53	0.65	0.04	0.00
101	1406785	15682	L-GU51-01	B 1-3	16	2.92	0.09	40.74	3.63	0.61	0.00
102	1607084	15682	L-GU51-01	B 1-3	25	2.89	0.10	52.19	4.92	0.80	0.00
103	1310849	15682	L-GU51-01	B 1-3	19	2.87	0.10	47.20	4.42	0.74	0.00

Liner Cell	Rod Number	Liner Number	Assembly Number	Liner no.	POB Category	Th-232 (kg)	U-232 (g)	U-233 (g)	U-234 (g)	U-235 (g)	U-238 (g)
104	1103407	15682	L-GU51-01	B 1-3	13	2.90	0.10	35.40	3.25	0.54	0
107	1200225	15682	L-GU51-01	B 1-3	13	2.90	0.10	35.40	3.25	0.54	0
108	1411084	15682	L-GU51-01	B 1-3	16	2.92	0.09	40.74	3.63	0.61	0
109	1607066	15682	L-GU51-01	B 1-3	25	2.89	0.10	52.19	4.92	0.80	0
110	2701476	15682	L-GT22-03	B 3-6	37	2.42	0.07	41.78	4.04	0.62	0
111	2301756	15682	L-GT22-03	B 3-6	33	2.42	0.05	46.13	3.53	0.47	0
112	2401746	15682	L-GT22-03	B 3-6	31	2.46	0.05	34.11	2.62	0.37	0
113	2202655	15682	L-GT22-03	B 3-6	29	2.45	0.05	28.98	2.29	0.31	0
122	1604179	15682	L-GT22-03	B 3-6	27	2.90	0.09	52.06	4.53	0.70	0
123	1413275	15682	L-GT22-03	B 3-6	18	2.92	0.08	39.40	3.21	0.50	0
124	1200766	15682	L-GT22-03	B 3-6	15	2.91	0.08	33.30	2.73	0.41	0
135	1512524	15682	L-GT22-03	B 3-6	24	2.88	0.09	46.71	4.29	0.67	0
136	1310813	15682	L-GT22-03	B 3-6	21	2.87	0.08	46.59	4.02	0.63	0
140	2701265	15682	L-GS22-01	B 2-2	36	2.42	0.07	41.72	4.14	0.64	0
141	2302443	15682	L-GS22-01	B 2-2	32	2.42	0.06	45.57	3.95	0.57	0
142	2100170	15682	L-GS22-01	B 2-2	28	2.45	0.06	30.09	2.67	0.40	0
143	2304459	15682	L-GS22-01	B 2-2	32	2.42	0.06	45.57	3.95	0.57	0
144	2512103	15682	L-GS22-01	B 2-2	34	2.43	0.05	53.87	3.78	0.47	0
145	2406088	15682	L-GS22-01	B 2-2	30	2.46	0.06	34.68	2.98	0.45	0
147	2401012	15682	L-GS22-01	B 2-2	30	2.46	0.06	34.68	2.98	0.45	0
242	2517087	15682	L-GW52-01	B 3-2	35	2.43	0.03	55.13	3.30	0.38	0
243	2503467	15682	L-GW52-01	B 3-2	35	2.43	0.03	55.13	3.30	0.38	0
244	2520784	15682	L-GW52-01	B 3-2	35	2.43	0.03	55.13	3.30	0.38	0
245	2511240	15682	L-GW52-01	B 3-2	35	2.43	0.03	55.13	3.30	0.38	0
246	2520766	15682	L-GW52-01	B 3-2	35	2.43	0.03	55.13	3.30	0.38	0
247	2511039	15682	L-GW52-01	B 3-2	35	2.43	0.03	55.13	3.30	0.38	0

Liner Cell	Rod Number	Liner Number	Assembly Number	Liner no.	POB Category	Th-232 (kg)	U-232 (g)	U-233 (g)	U-234 (g)	U-235 (g)	U-238 (g)
248	2505079	15682	L-GW52-01	B 3-2	35	2.43	0.03	55.13	3.30	0.38	0
249	2517657	15682	L-GW52-01	B 3-2	35	2.43	0.03	55.13	3.30	0.38	0
250	2512780	15682	L-GW52-01	B 3-2	35	2.43	0.03	55.13	3.30	0.38	0
251	2518656	15682	L-GW52-01	B 3-2	35	2.43	0.03	55.13	3.30	0.38	0
252	2505584	15682	L-GW52-01	B 3-2	35	2.43	0.03	55.13	3.30	0.38	0
253	2511452	15682	L-GW52-01	B 3-2	35	2.43	0.03	55.13	3.30	0.38	0
254	2510536	15682	L-GW52-01	B 3-2	35	2.43	0.03	55.13	3.30	0.38	0
255	2504420	15682	L-GW52-01	B 3-2	35	2.43	0.03	55.13	3.30	0.38	0
256	2516438	15682	L-GW52-01	B 3-2	35	2.43	0.03	55.13	3.30	0.38	0
257	2516402	15682	L-GW52-01	B 3-2	35	2.43	0.03	55.13	3.30	0.38	0
258	2506345	15682	L-GW52-01	B 3-2	35	2.43	0.03	55.13	3.30	0.38	0
259	2502248	15682	L-GW52-01	B 3-2	35	2.43	0.03	55.13	3.30	0.38	0
260	2520573	15682	L-GW52-01	B 3-2	35	2.43	0.03	55.13	3.30	0.38	0
261	2518243	15682	L-GW52-01	B 3-2	35	2.43	0.03	55.13	3.30	0.38	0
262	2513809	15682	L-GW52-01	B 3-2	35	2.43	0.03	55.13	3.30	0.38	0
263	2511149	15682	L-GW52-01	B 3-2	35	2.43	0.03	55.13	3.30	0.38	0
264	2516162	15682	L-GW52-01	B 3-2	35	2.43	0.03	55.13	3.30	0.38	0
265	2302268	15682	L-GW52-01	B 3-2	33	2.42	0.05	46.13	3.53	0.47	0
266	2101666	15682	L-GW52-01	B 3-2	29	2.45	0.05	28.98	2.29	0.31	0
267	2608378	15682	L-GW52-01	B 3-2	35	2.43	0.03	55.13	3.30	0.38	0
268	2611359	15682	L-GW52-01	B 3-2	35	2.43	0.03	55.13	3.30	0.38	0
269	2606317	15682	L-GW52-01	B 3-2	35	2.43	0.03	55.13	3.30	0.38	0
270	2620646	15682	L-GW52-01	B 3-2	35	2.43	0.03	55.13	3.30	0.38	0
271	2604245	15682	L-GW52-01	B 3-2	35	2.43	0.03	55.13	3.30	0.38	0
272	2612587	15682	L-GW52-01	B 3-2	35	2.43	0.03	55.13	3.30	0.38	0
273	2618765	15682	L-GW52-01	B 3-2	35	2.43	0.03	55.13	3.30	0.38	0

Liner Cell	Rod Number	Liner Number	Assembly Number	Liner no.	POB Category	Th-232 (kg)	U-232 (g)	U-233 (g)	U-234 (g)	U-235 (g)	U-238 (g)
274	2612028	15682	L-GW52-01	B 3-2	35	2.43	0.03	55.13	3.30	0.38	0
275	2600010	15682	L-GW52-01	B 3-2	35	2.43	0.03	55.13	3.30	0.38	0
276	2602202	15682	L-GW52-01	B 3-2	35	2.43	0.03	55.13	3.30	0.38	0
277	2616730	15682	L-GW52-01	B 3-2	35	2.43	0.03	55.13	3.30	0.38	0
278	2613485	15682	L-GW52-01	B 3-2	35	2.43	0.03	55.13	3.30	0.38	0
279	2603412	15682	L-GW52-01	B 3-2	35	2.43	0.03	55.13	3.30	0.38	0
280	2402175	15682	L-GW52-01	B 3-2	31	2.46	0.05	34.11	2.62	0.37	0
281	2616327	15682	L-GW52-01	B 3-2	35	2.43	0.03	55.13	3.30	0.38	0
282	2602036	15682	L-GW52-01	B 3-2	35	2.43	0.03	55.13	3.30	0.38	0
283	2402276	15682	L-GW52-01	B 3-2	31	2.46	0.05	34.11	2.62	0.37	0
284	2621829	15682	L-GW52-01	B 3-2	35	2.43	0.03	55.13	3.30	0.38	0
285	2620884	15682	L-GW52-01	B 3-2	35	2.43	0.03	55.13	3.30	0.38	0
286	2403073	15682	L-GW52-01	B 3-2	31	2.46	0.05	34.11	2.62	0.37	0
287	2200134	15682	L-GW52-01	B 3-2	29	2.45	0.05	28.98	2.29	0.31	0
288	2205055	15682	L-GW52-01	B 3-2	29	2.45	0.05	28.98	2.29	0.31	0
289	2620049	15682	L-GW52-01	B 3-2	35	2.43	0.03	55.13	3.30	0.38	0
290	2608517	15682	L-GW52-01	B 3-2	35	2.43	0.03	55.13	3.30	0.38	0
291	2402340	15682	L-GW52-01	B 3-2	31	2.46	0.05	34.11	2.62	0.37	0
292	2204763	15682	L-GW52-01	B 3-2	29	2.45	0.05	28.98	2.29	0.31	0
293	2520867	15682	L-GW52-01	B 3-2	35	2.43	0.03	55.13	3.30	0.38	0
294	2503072	15682	L-GW52-01	B 3-2	35	2.43	0.03	55.13	3.30	0.38	0
295	2510076	15682	L-GW52-01	B 3-2	35	2.43	0.03	55.13	3.30	0.38	0
296	2303112	15682	L-GW52-01	B 3-2	33	2.42	0.05	46.13	3.53	0.47	0
297	2520463	15682	L-GW52-01	B 3-2	35	2.43	0.03	55.13	3.30	0.38	0
298	2304046	15682	L-GW52-01	B 3-2	33	2.42	0.05	46.13	3.53	0.47	0
299	2103417	15682	L-GW52-01	B 3-2	29	2.45	0.05	28.98	2.29	0.31	0

Liner Cell	Rod Number	Liner Number	Assembly Number	Liner no.	POB Category	Th-232 (kg)	U-232 (g)	U-233 (g)	U-234 (g)	U-235 (g)	U-238 (g)
300	2501433	15682	L-GW52-01	B 3-2	35	2.43	0.03	55.13	3.30	0.38	0
301	2517161	15682	L-GW52-01	B 3-2	35	2.43	0.03	55.13	3.30	0.38	0
302	2512010	15682	L-GW52-01	B 3-2	35	2.43	0.03	55.13	3.30	0.38	0
303	2305808	15682	L-GW52-01	B 3-2	33	2.42	0.05	46.13	3.53	0.47	0
304	2517217	15682	L-GW52-01	B 3-2	35	2.43	0.03	55.13	3.30	0.38	0
305	2303305	15682	L-GW52-01	B 3-2	33	2.42	0.05	46.13	3.53	0.47	0
306	2101877	15682	L-GW52-01	B 3-2	29	2.45	0.05	28.98	2.29	0.31	0
307	2515329	15682	L-GW52-01	B 3-2	35	2.43	0.03	55.13	3.30	0.38	0
308	2517482	15682	L-GW52-01	B 3-2	35	2.43	0.03	55.13	3.30	0.38	0
309	2302874	15682	L-GW52-01	B 3-2	33	2.42	0.05	46.13	3.53	0.47	0
310	2100337	15682	L-GW52-01	B 3-2	29	2.45	0.05	28.98	2.29	0.31	0
311	2604135	15682	L-GW52-01	B 3-2	35	2.43	0.03	55.13	3.30	0.38	0
312	2404606	15682	L-GW52-01	B 3-2	31	2.46	0.05	34.11	2.62	0.37	0
313	2200116	15682	L-GW52-01	B 3-2	29	2.45	0.05	28.98	2.29	0.31	0
314	2200704	15682	L-GW52-01	B 3-2	29	2.45	0.05	28.98	2.29	0.31	0
315	2620637	15682	L-GW52-01	B 3-2	35	2.43	0.03	55.13	3.30	0.38	0
316	2604254	15682	L-GW52-01	B 3-2	35	2.43	0.03	55.13	3.30	0.38	0
317	2600819	15682	L-GW52-01	B 3-2	35	2.43	0.03	55.13	3.30	0.38	0
318	2406373	15682	L-GW52-01	B 3-2	31	2.46	0.05	34.11	2.62	0.37	0
319	2202334	15682	L-GW52-01	B 3-2	29	2.45	0.05	28.98	2.29	0.31	0
320	2612634	15682	L-GW52-01	B 3-2	35	2.43	0.03	55.13	3.30	0.38	0
321	2614879	15682	L-GW52-01	B 3-2	35	2.43	0.03	55.13	3.30	0.38	0
322	2602650	15682	L-GW52-01	B 3-2	35	2.43	0.03	55.13	3.30	0.38	0
323	2403046	15682	L-GW52-01	B 3-2	31	2.46	0.05	34.11	2.62	0.37	0
324	2200501	15682	L-GW52-01	B 3-2	29	2.45	0.05	28.98	2.29	0.31	0
601	2200840	15682	L-GT22-03	B 3-6	29	2.45	0.05	28.98	2.29	0.31	0

Liner Cell	Rod Number	Liner Number	Assembly Number	Liner no.	POB Category	Th-232 (kg)	U-232 (g)	U-233 (g)	U-234 (g)	U-235 (g)	U-238 (g)
607	2513880	15682	L-GT22-03	B 3-6	35	2.43	0.03	55.13	3.30	0.38	0
608	2518169	15682	L-GT22-03	B 3-6	35	2.43	0.03	55.13	3.30	0.38	0
609	2507720	15682	L-GT22-03	B 3-6	35	2.43	0.03	55.13	3.30	0.38	0
610	2700643	15682	L-GW52-01	B 3-2	37	2.42	0.07	41.78	4.04	0.62	0
611	2300601	15682	L-GW52-01	B 3-2	33	2.42	0.05	46.13	3.53	0.47	0
612	2300279	15682	L-GW52-01	B 3-2	33	2.42	0.05	46.13	3.53	0.47	0
613	2304652	15682	L-GW52-01	B 3-2	33	2.42	0.05	46.13	3.53	0.47	0
614	1612357	15682	L-GU51-01	B 1-3	25	2.89	0.10	52.19	4.92	0.80	0
615	1606278	15682	L-GU51-01	B 1-3	25	2.89	0.10	52.19	4.92	0.80	0
616	2517179	15682	L-GW52-01	B 3-2	35	2.43	0.03	55.13	3.30	0.38	0
617	1604758	15682	L-GU51-01	B 1-3	25	2.89	0.10	52.19	4.92	0.80	0
618	1404356	15682	L-GU51-01	B 1-3	16	2.92	0.09	40.74	3.63	0.61	0
619	1411479	15682	L-GU51-01	B 1-3	16	2.92	0.09	40.74	3.63	0.61	0
620	2502082	15682	L-GW52-01	B 3-2	35	2.43	0.03	55.13	3.30	0.38	0
621	2521022	15682	L-GW52-01	B 3-2	35	2.43	0.03	55.13	3.30	0.38	0
622	1200500	15682	L-GU51-01	B 1-3	13	2.90	0.10	35.40	3.25	0.54	0
623	1208042	15682	L-GU51-01	B 1-3	13	2.90	0.10	35.40	3.25	0.54	0
624	1206347	15682	L-GU51-01	B 1-3	13	2.90	0.10	35.40	3.25	0.54	0
625	1510589	15682	L-GU51-01	B 1-3	22	2.88	0.10	47.04	4.66	0.76	0
626	1311811	15682	L-GU51-01	B 1-3	19	2.87	0.10	47.20	4.42	0.74	0
627	1307152	15682	L-GU51-01	B 1-3	19	2.87	0.10	47.20	4.42	0.74	0
628	1107750	15682	L-GU51-01	B 1-3	13	2.90	0.10	35.40	3.25	0.54	0
629	1105477	15682	L-GU51-01	B 1-3	13	2.90	0.10	35.40	3.25	0.54	0
630	1507058	15682	L-GU51-01	B 1-3	22	2.88	0.10	47.04	4.66	0.76	0
631	1506683	15682	L-GU51-01	B 1-3	22	2.88	0.10	47.04	4.66	0.76	0
632	1500386	15682	L-GU51-01	B 1-3	22	2.88	0.10	47.04	4.66	0.76	0

Liner Cell	Rod Number	Liner Number	Assembly Number	Liner no.	POB Category	Th-232 (kg)	U-232 (g)	U-233 (g)	U-234 (g)	U-235 (g)	U-238 (g)
633	1500846	15682	L-GU51-01	B 1-3	22	2.88	0.10	47.04	4.66	0.76	0
634	1107623	15682	L-GU51-01	B 1-3	13	2.90	0.10	35.40	3.25	0.54	0
635	1103700	15682	L-GU51-01	B 1-3	13	2.90	0.10	35.40	3.25	0.54	0
636	1106844	15682	L-GU51-01	B 1-3	13	2.90	0.10	35.40	3.25	0.54	0
637	1610157	15682	L-GU51-01	B 1-3	25	2.89	0.10	52.19	4.92	0.80	0
638	1503742	15682	L-GU51-01	B 1-3	22	2.88	0.10	47.04	4.66	0.76	0
639	2518041	15682	L-GW52-01	B 3-2	35	2.43	0.03	55.13	3.30	0.38	0
640	1302873	15682	L-GU51-01	B 1-3	19	2.87	0.10	47.20	4.42	0.74	0
641	1500157	15682	L-GU51-01	B 1-3	22	2.88	0.10	47.04	4.66	0.76	0
642	2610167	15682	L-GT22-03	B 3-6	35	2.43	0.03	55.13	3.30	0.38	0
643	2615512	15682	L-GT22-03	B 3-6	35	2.43	0.03	55.13	3.30	0.38	0
644	2622617	15682	L-GT22-03	B 3-6	35	2.43	0.03	55.13	3.30	0.38	0
645	2607509	15682	L-GT22-03	B 3-6	35	2.43	0.03	55.13	3.30	0.38	0
646	2605502	15682	L-GT22-03	B 3-6	35	2.43	0.03	55.13	3.30	0.38	0
647	2622507	15682	L-GT22-03	B 3-6	35	2.43	0.03	55.13	3.30	0.38	0
648	2404018	15682	L-GT22-03	B 3-6	31	2.46	0.05	34.11	2.62	0.37	0
649	2204846	15682	L-GT22-03	B 3-6	29	2.45	0.05	28.98	2.29	0.31	0
650	2616684	15682	L-GT22-03	B 3-6	35	2.43	0.03	55.13	3.30	0.38	0
651	2600377	15682	L-GT22-03	B 3-6	35	2.43	0.03	55.13	3.30	0.38	0
652	2606876	15682	L-GT22-03	B 3-6	35	2.43	0.03	55.13	3.30	0.38	0
653	2601367	15682	L-GT22-03	B 3-6	35	2.43	0.03	55.13	3.30	0.38	0
654	2101464	15682	L-GT22-03	B 3-6	29	2.45	0.05	28.98	2.29	0.31	0
655	2612735	15682	L-GT22-03	B 3-6	35	2.43	0.03	55.13	3.30	0.38	0
656	2600314	15682	L-GT22-03	B 3-6	35	2.43	0.03	55.13	3.30	0.38	0
657	2501670	15682	L-GT22-03	B 3-6	35	2.43	0.03	55.13	3.30	0.38	0
658	2513634	15682	L-GT22-03	B 3-6	35	2.43	0.03	55.13	3.30	0.38	0

Liner Cell	Rod Number	Liner Number	Assembly Number	Liner no.	POB Category	Th-232 (kg)	U-232 (g)	U-233 (g)	U-234 (g)	U-235 (g)	U-238 (g)
659	2501157	15682	L-GT22-03	B 3-6	35	2.43	0.03	55.13	3.30	0.38	0.00
660	2700414	15682	L-GT22-03	B 3-6	37	2.42	0.07	41.78	4.04	0.62	0.00
661	2503808	15682	L-GT22-03	B 3-6	35	2.43	0.03	55.13	3.30	0.38	0.00
662	2514045	15682	L-GT22-03	B 3-6	35	2.43	0.03	55.13	3.30	0.38	0.00
663	2512579	15682	L-GT22-03	B 3-6	35	2.43	0.03	55.13	3.30	0.38	0.00
664	2517226	15682	L-GT22-03	B 3-6	35	2.43	0.03	55.13	3.30	0.38	0.00
665	2516824	15682	L-GT22-03	B 3-6	35	2.43	0.03	55.13	3.30	0.38	0.00
666	2500618	15682	L-GT22-03	B 3-6	35	2.43	0.03	55.13	3.30	0.38	0.00
667	2500589	15682	L-GT22-03	B 3-6	35	2.43	0.03	55.13	3.30	0.38	0.00
668	2503018	15682	L-GT22-03	B 3-6	35	2.43	0.03	55.13	3.30	0.38	0.00
669	2622083	15682	L-GT22-03	B 3-6	35	2.43	0.03	55.13	3.30	0.38	0.00
670	2617005	15682	L-GT22-03	B 3-6	35	2.43	0.03	55.13	3.30	0.38	0.00
671	2612827	15682	L-GT22-03	B 3-6	35	2.43	0.03	55.13	3.30	0.38	0.00
672	2600745	15682	L-GT22-03	B 3-6	35	2.43	0.03	55.13	3.30	0.38	0.00
673	2502578	15682	L-GT22-03	B 3-6	35	2.43	0.03	55.13	3.30	0.38	0.00
674	2510738	15682	L-GT22-03	B 3-6	35	2.43	0.03	55.13	3.30	0.38	0.00
180	3107082	15683	L-RA01-09	R 4-4	42	6.04	0.04	32.39	1.22	0.10	0.00
181	3206304	15683	L-RA01-09	R 4-4	40	6.08	0.01	16.57	0.32	0.01	0.00
182	3220018	15683	L-RA01-03	R 4-9	40	6.08	0.01	16.57	0.32	0.01	0.00
183	3116856	15683	L-RA01-09	R 4-4	40	6.08	0.01	16.57	0.32	0.01	0.00
184	3217578	15683	L-RA01-09	R 4-4	39	6.09	0.00	10.34	0.13	0.00	0.00
185	3103885	15683	L-RA01-09	R 4-4	38	6.09	0.00	4.99	0.03	0.00	0.00
186	3123373	15683	L-RA01-09	R 4-4	38	6.09	0.00	4.99	0.03	0.00	0.00
187	3116223	15683	L-RA01-09	R 4-4	39	6.09	0.00	10.34	0.13	0.00	0.00
188	3107102	15683	L-RA01-09	R 4-4	41	6.07	0.02	23.53	0.65	0.04	0.00
189	3201069	15683	L-RA01-09	R 4-4	40	6.08	0.01	16.57	0.32	0.01	0.00

Liner Cell	Rod Number	Liner Number	Assembly Number	Liner no.	POB Category	Th-232 (kg)	U-232 (g)	U-233 (g)	U-234 (g)	U-235 (g)	U-238 (g)
190	3218505	15683	L-RA01-09	R 4-4	40	6.08	0.01	16.57	0.32	0.01	0.00
191	3202674	15683	L-RA01-09	R 4-4	41	6.07	0.02	23.53	0.65	0.04	0.00
601	3102143	15683	Calibration	N/A	Unirrad	6.04	0.00	0.00	0.00	0.00	0.00
602	31124	15683	Calibration	N/A	Unirrad	5.98	0.00	69.40	0.82	0.06	0.00
603	31063	15683	Calibration	N/A	Unirrad	6.04	0.00	29.05	0.34	0.03	0.00
604	31123	15683	Calibration	N/A	Unirrad	5.98	0.00	69.36	0.82	0.06	0.00
605	3106718	15683	Calibration	N/A	Unirrad	6.09	0.00	0.00	0.00	0.00	0.00
606	31062	15683	Calibration	N/A	Unirrad	6.03	0.00	29.05	0.34	0.03	0.00
607	3108707	15683	Calibration	N/A	Unirrad	6.03	0.00	0.00	0.00	0.00	0.00
609	3203545	15683	L-RA01-09	R 4-4	41	6.07	0.02	23.53	0.65	0.04	0.00
610	3220751	15683	L-RA01-09	R 4-4	42	6.04	0.04	32.39	1.22	0.10	0.00
611	3127075	15683	L-RA01-09	R 4-4	40	6.08	0.01	16.57	0.32	0.01	0.00
612	3216258	15683	L-RA01-09	R 4-4	38	6.09	0.00	4.99	0.03	0.00	0.00
613	3214875	15683	L-RA01-09	R 4-4	42	6.04	0.04	32.39	1.22	0.10	0.00
614	3103555	15683	L-RA01-09	R 4-4	41	6.07	0.02	23.53	0.65	0.04	0.00
615	3118708	15683	L-RA01-09	R 4-4	41	6.07	0.02	23.53	0.65	0.04	0.00
617	3203379	15683	L-RA01-09	R 4-4	41	6.07	0.02	23.53	0.65	0.04	0.00
619	3104664	15683	L-RA01-09	R 4-4	40	6.08	0.01	16.57	0.32	0.01	0.00
620	3122163	15683	L-RA01-09	R 4-4	39	6.09	0.00	10.34	0.13	0.00	0.00
621	3222833	15683	L-RA01-09	R 4-4	39	6.09	0.00	10.34	0.13	0.00	0.00
622	3216139	15683	L-RA01-09	R 4-4	38	6.09	0.00	4.99	0.03	0.00	0.00
623	3217506	15683	L-RA01-09	R 4-4	40	6.08	0.01	16.57	0.32	0.01	0.00
624	3116167	15683	L-RA01-09	R 4-4	42	6.04	0.04	32.39	1.22	0.10	0.00
625	3118019	15683	L-RA01-09	R 4-4	38	6.09	0.00	4.99	0.03	0.00	0.00
626	3113006	15683	L-RA01-09	R 4-4	38	6.09	0.00	4.99	0.03	0.00	0.00
627	3120744	15683	L-RA01-09	R 4-4	38	6.09	0.00	4.99	0.03	0.00	0.00

Liner Cell	Rod Number	Liner Number	Assembly Number	Liner no.	POB Category	Th-232 (kg)	U-232 (g)	U-233 (g)	U-234 (g)	U-235 (g)	U-238 (g)
629	3208127	15683	L-RA01-09	R 4-4	41	6.07	0.02	23.53	0.65	0.04	0.00
630	3211236	15683	L-RA01-09	R 4-4	42	6.04	0.04	32.39	1.22	0.10	0.00
631	3217266	15683	L-RA01-09	R 4-4	42	6.04	0.04	32.39	1.22	0.10	0.00
632	3218413	15683	L-RA01-09	R 4-4	39	6.09	0.00	10.34	0.13	0.00	0.00
633	3218669	15683	L-RA01-09	R 4-4	39	6.09	0.00	10.34	0.13	0.00	0.00
634	3222474	15683	L-RA01-09	R 4-4	38	6.09	0.00	4.99	0.03	0.00	0.00
635	3203774	15683	L-RA01-09	R 4-4	38	6.09	0.00	4.99	0.03	0.00	0.00
636	3207458	15683	L-RB01-08	R 5-4	50	6.07	0.01	19.14	0.42	0.02	0.00
637	3204654	15683	L-RB01-08	R 5-4	50	6.07	0.01	19.14	0.42	0.02	0.00
638	3206762	15683	L-RB01-08	R 5-4	50	6.07	0.01	19.14	0.42	0.02	0.00
639	3201380	15683	L-RB01-08	R 5-4	50	6.07	0.01	19.14	0.42	0.02	0.00
640	3226636	15683	L-RB01-08	R 5-4	50	6.07	0.01	19.14	0.42	0.02	0.00
641	3213629	15683	L-RB01-08	R 5-4	50	6.07	0.01	19.14	0.42	0.02	0.00
642	3122605	15683	L-RA01-09	R 4-4	39	6.09	0.00	10.34	0.13	0.00	0.00
643	3126470	15683	L-RA01-09	R 4-4	40	6.08	0.01	16.57	0.32	0.01	0.00
644	3105488	15683	L-RA01-09	R 4-4	40	6.08	0.01	16.57	0.32	0.01	0.00
645	3123245	15683	L-RA01-09	R 4-4	39	6.09	0.00	10.34	0.13	0.00	0.00
648	3111228	15683	L-RB01-08	R 5-4	50	6.07	0.01	19.14	0.42	0.02	0.00
649	3106819	15683	L-RB01-08	R 5-4	50	6.07	0.01	19.14	0.42	0.02	0.00
650	3100228	15683	L-RB01-08	R 5-4	50	6.07	0.01	19.14	0.42	0.02	0.00
651	3102318	15683	L-RB01-08	R 5-4	50	6.07	0.01	19.14	0.42	0.02	0.00
652	3111513	15683	L-RB01-08	R 5-4	48	6.09	0.00	4.80	0.03	0.00	0.00
653	3102620	15683	L-RB01-08	R 5-4	48	6.09	0.00	4.80	0.03	0.00	0.00
654	3106635	15683	L-RB01-08	R 5-4	48	6.09	0.00	4.80	0.03	0.00	0.00
655	3106846	15683	L-RB01-08	R 5-4	48	6.09	0.00	4.80	0.03	0.00	0.00
656	3204663	15683	L-RB01-08	R 5-4	49	6.09	0.00	10.46	0.12	0.00	0.00

Liner Cell	Rod Number	Liner Number	Assembly Number	Liner no.	POB Category	Th-232 (kg)	U-232 (g)	U-233 (g)	U-234 (g)	U-235 (g)	U-238 (g)
657	3210136	15683	L-RB01-08	R 5-4	48	6.09	0.00	4.80	0.03	0.00	0.00
658	3201160	15683	L-RB01-08	R 5-4	48	6.09	0.00	4.80	0.03	0.00	0.00
659	3223675	15683	L-RB01-08	R 5-4	48	6.09	0.00	4.80	0.03	0.00	0.00
660	3208852	15683	L-RB01-08	R 5-4	48	6.09	0.00	4.80	0.03	0.00	0.00
661	3204810	15683	L-RB01-08	R 5-4	48	6.09	0.00	4.80	0.03	0.00	0.00
662	3201464	15683	L-RB01-08	R 5-4	48	6.09	0.00	4.80	0.03	0.00	0.00
663	3200815	15683	L-RB01-08	R 5-4	48	6.09	0.00	4.80	0.03	0.00	0.00
664	3204609	15683	L-RB01-08	R 5-4	49	6.09	0.00	10.46	0.12	0.00	0.00
665	3220182	15683	L-RB01-08	R 5-4	49	6.09	0.00	10.46	0.12	0.00	0.00
666	3206423	15683	L-RB01-08	R 5-4	49	6.09	0.00	10.46	0.12	0.00	0.00
667	3203030	15683	L-RB01-08	R 5-4	49	6.09	0.00	10.46	0.12	0.00	0.00
668	3110624	15683	L-RA01-10	R 4-3	46	6.08	0.02	22.42	0.59	0.04	0.00
670	3207716	15683	L-RA01-10	R 4-3	47	6.04	0.04	30.97	1.12	0.09	0.00
671	3220357	15683	L-RA01-10	R 4-3	47	6.04	0.04	30.97	1.12	0.09	0.00
672	3225453	15683	L-RB01-08	R 5-4	50	6.07	0.01	19.14	0.42	0.02	0.00
673	3204636	15683	L-RB01-08	R 5-4	49	6.09	0.00	10.46	0.12	0.00	0.00
674	3200705	15683	L-RB01-08	R 5-4	49	6.09	0.00	10.46	0.12	0.00	0.00
675	3217275	15683	L-RB01-08	R 5-4	49	6.09	0.00	10.46	0.12	0.00	0.00
101	1612210	15684	L-GW52-01	B 3-2	27	2.90	0.09	52.06	4.53	0.70	0.00
102	1614824	15684	L-GW52-01	B 3-2	27	2.90	0.09	52.06	4.53	0.70	0.00
103	1606884	15684	L-GW52-01	B 3-2	27	2.90	0.09	52.06	4.53	0.70	0.00
104	1600330	15684	L-GW52-01	B 3-2	27	2.90	0.09	52.06	4.53	0.70	0.00
105	1611275	15684	L-GW52-01	B 3-2	27	2.90	0.09	52.06	4.53	0.70	0.00
106	1602071	15684	L-GW52-01	B 3-2	27	2.90	0.09	52.06	4.53	0.70	0.00
107	1607571	15684	L-GW52-01	B 3-2	27	2.90	0.09	52.06	4.53	0.70	0.00
108	1514513	15684	L-GW52-01	B 3-2	24	2.88	0.09	46.71	4.29	0.67	0.00

Liner Cell	Rod Number	Liner Number	Assembly Number	Liner no.	POB Category	Th-232 (kg)	U-232 (g)	U-233 (g)	U-234 (g)	U-235 (g)	U-238 (g)
109	1510874	15684	L-GW52-01	B 3-2	24	2.88	0.09	46.71	4.29	0.67	0
110	1500184	15684	L-GW52-01	B 3-2	24	2.88	0.09	46.71	4.29	0.67	0
111	1504144	15684	L-GW52-01	B 3-2	24	2.88	0.09	46.71	4.29	0.67	0
112	1500727	15684	L-GW52-01	B 3-2	24	2.88	0.09	46.71	4.29	0.67	0
113	1514329	15684	L-GW52-01	B 3-2	24	2.88	0.09	46.71	4.29	0.67	0
114	1510883	15684	L-GW52-01	B 3-2	24	2.88	0.09	46.71	4.29	0.67	0
115	1508865	15684	L-GW52-01	B 3-2	24	2.88	0.09	46.71	4.29	0.67	0
116	1405714	15684	L-GW52-01	B 3-2	18	2.92	0.08	39.40	3.21	0.50	0
117	1312764	15684	L-GW52-01	B 3-2	21	2.87	0.08	46.59	4.02	0.63	0
118	1303652	15684	L-GW52-01	B 3-2	21	2.87	0.08	46.59	4.02	0.63	0
119	1301387	15684	L-GW52-01	B 3-2	21	2.87	0.08	46.59	4.02	0.63	0
120	1302670	15684	L-GW52-01	B 3-2	21	2.87	0.08	46.59	4.02	0.63	0
121	1101555	15684	L-GW52-01	B 3-2	15	2.91	0.08	33.30	2.73	0.41	0
122	1110280	15684	L-GW52-01	B 3-2	15	2.91	0.08	33.30	2.73	0.41	0
123	1311215	15684	L-GW52-01	B 3-2	21	2.87	0.08	46.59	4.02	0.63	0
124	1408518	15684	L-GW52-01	B 3-2	18	2.92	0.08	39.40	3.21	0.50	0
125	1408554	15684	L-GW52-01	B 3-2	18	2.92	0.08	39.40	3.21	0.50	0
126	1206677	15684	L-GW52-01	B 3-2	15	2.91	0.08	33.30	2.73	0.41	0
127	1205788	15684	L-GW52-01	B 3-2	15	2.91	0.08	33.30	2.73	0.41	0
128	1208161	15684	L-GW52-01	B 3-2	15	2.91	0.08	33.30	2.73	0.41	0
129	1207447	15684	L-GW52-01	B 3-2	15	2.91	0.08	33.30	2.73	0.41	0
130	1401608	15684	L-GW52-01	B 3-2	18	2.92	0.08	39.40	3.21	0.50	0
131	1607048	15684	L-GW52-01	B 3-2	27	2.90	0.09	52.06	4.53	0.70	0
132	1304889	15684	L-GW52-01	B 3-2	21	2.87	0.08	46.59	4.02	0.63	0
133	1506288	15684	L-GW52-01	B 3-2	24	2.88	0.09	46.71	4.29	0.67	0
134	1502862	15684	L-GW52-01	B 3-2	24	2.88	0.09	46.71	4.29	0.67	0

Liner Cell	Rod Number	Liner Number	Assembly Number	Liner no.	POB Category	Th-232 (kg)	U-232 (g)	U-233 (g)	U-234 (g)	U-235 (g)	U-238 (g)
135	1514614	15684	L-GW52-01	B 3-2	24	2.88	0.09	46.71	4.29	0.67	0
136	1514585	15684	L-GW52-01	B 3-2	24	2.88	0.09	46.71	4.29	0.67	0
137	1502009	15684	L-GW52-01	B 3-2	24	2.88	0.09	46.71	4.29	0.67	0
138	1514374	15684	L-GW52-01	B 3-2	24	2.88	0.09	46.71	4.29	0.67	0
139	1511543	15684	L-GW52-01	B 3-2	24	2.88	0.09	46.71	4.29	0.67	0
140	1312856	15684	L-GW52-01	B 3-2	21	2.87	0.08	46.59	4.02	0.63	0
141	1302038	15684	L-GW52-01	B 3-2	21	2.87	0.08	46.59	4.02	0.63	0
143	1308032	15684	L-GW52-01	B 3-2	21	2.87	0.08	46.59	4.02	0.63	0
144	1308537	15684	L-GW52-01	B 3-2	21	2.87	0.08	46.59	4.02	0.63	0
145	1110060	15684	L-GW52-01	B 3-2	15	2.91	0.08	33.30	2.73	0.41	0
146	1104837	15684	L-GW52-01	B 3-2	15	2.91	0.08	33.30	2.73	0.41	0
147	1205430	15684	L-GW52-01	B 3-2	15	2.91	0.08	33.30	2.73	0.41	0
148	1202214	15684	L-GW52-01	B 3-2	15	2.91	0.08	33.30	2.73	0.41	0
149	1205210	15684	L-GW52-01	B 3-2	15	2.91	0.08	33.30	2.73	0.41	0
150	1615042	15684	L-GW52-01	B 3-2	27	2.90	0.09	52.06	4.53	0.70	0
151	1608561	15684	L-GW52-01	B 3-2	27	2.90	0.09	52.06	4.53	0.70	0
152	1612413	15684	L-GW52-01	B 3-2	27	2.90	0.09	52.06	4.53	0.70	0
153	1614777	15684	L-GW52-01	B 3-2	27	2.90	0.09	52.06	4.53	0.70	0
154	1612274	15684	L-GW52-01	B 3-2	27	2.90	0.09	52.06	4.53	0.70	0
155	1606114	15684	L-GW52-01	B 3-2	27	2.90	0.09	52.06	4.53	0.70	0
156	1408509	15684	L-GW52-01	B 3-2	18	2.92	0.08	39.40	3.21	0.50	0
158	1408177	15684	L-GW52-01	B 3-2	18	2.92	0.08	39.40	3.21	0.50	0
159	1413468	15684	L-GW52-01	B 3-2	18	2.92	0.08	39.40	3.21	0.50	0
160	1602724	15684	L-GW52-01	B 3-2	27	2.90	0.09	52.06	4.53	0.70	0
161	1606756	15684	L-GW52-01	B 3-2	27	2.90	0.09	52.06	4.53	0.70	0
163	2621728	15684	L-GW52-01	B 3-2	35	2.43	0.03	55.13	3.30	0.38	0

Liner Cell	Rod Number	Liner Number	Assembly Number	Liner no.	POB Category	Th-232 (kg)	U-232 (g)	U-233 (g)	U-234 (g)	U-235 (g)	U-238 (g)
164	2404615	15684	L-GW52-01	B 3-2	31	2.46	0.05	34.11	2.62	0.37	0
165	2202352	15684	L-GW52-01	B 3-2	29	2.45	0.05	28.98	2.29	0.31	0
166	1401754	15684	L-GW52-01	B 3-2	18	2.92	0.08	39.40	3.21	0.50	0
167	1201307	15684	L-GW52-01	B 3-2	15	2.91	0.08	33.30	2.73	0.41	0
168	2515860	15684	L-GW52-01	B 3-2	35	2.43	0.03	55.13	3.30	0.38	0
169	2700660	15684	L-GW52-01	B 3-2	37	2.42	0.07	41.78	4.04	0.62	0
170	2302130	15684	L-GW52-01	B 3-2	33	2.42	0.05	46.13	3.53	0.47	0
171	2505272	15684	L-GW52-01	B 3-2	35	2.43	0.03	55.13	3.30	0.38	0
172	2501588	15684	L-GW52-01	B 3-2	35	2.43	0.03	55.13	3.30	0.38	0
173	2516878	15684	L-GW52-01	B 3-2	35	2.43	0.03	55.13	3.30	0.38	0
174	2513827	15684	L-GW52-01	B 3-2	35	2.43	0.03	55.13	3.30	0.38	0
324	1103167	15684	L-GW52-01	B 3-2	15	2.91	0.08	33.30	2.73	0.41	0
601	2517208	15684	L-GT22-03	B 3-6	35	2.43	0.03	55.13	3.30	0.38	0
602	2505236	15684	L-GT22-03	B 3-6	35	2.43	0.03	55.13	3.30	0.38	0
603	2701430	15684	L-GT22-03	B 3-6	37	2.42	0.07	41.78	4.04	0.62	0
604	2305449	15684	L-GT22-03	B 3-6	33	2.42	0.05	46.13	3.53	0.47	0
605	2305312	15684	L-GT22-03	B 3-6	33	2.42	0.05	46.13	3.53	0.47	0
606	2101363	15684	L-GT22-03	B 3-6	29	2.45	0.05	28.98	2.29	0.31	0
607	2620747	15684	L-GT22-03	B 3-6	35	2.43	0.03	55.13	3.30	0.38	0
608	2612625	15684	L-GT22-03	B 3-6	35	2.43	0.03	55.13	3.30	0.38	0
609	2613413	15684	L-GT22-03	B 3-6	35	2.43	0.03	55.13	3.30	0.38	0
610	2622175	15684	L-GT22-03	B 3-6	35	2.43	0.03	55.13	3.30	0.38	0
611	2604887	15684	L-GT22-03	B 3-6	35	2.43	0.03	55.13	3.30	0.38	0
612	2305853	15684	L-GT22-03	B 3-6	33	2.42	0.05	46.13	3.53	0.47	0
613	2406355	15684	L-GT22-03	B 3-6	31	2.46	0.05	34.11	2.62	0.37	0
614	2204855	15684	L-GT22-03	B 3-6	29	2.45	0.05	28.98	2.29	0.31	0

Liner Cell	Rod Number	Liner Number	Assembly Number	Liner no.	POB Category	Th-232 (kg)	U-232 (g)	U-233 (g)	U-234 (g)	U-235 (g)	U-238 (g)
615	2610223	15684	L-GS22-01	B 2-2	34	2.43	0.05	53.87	3.78	0.47	0
616	2613505	15684	L-GS22-01	B 2-2	34	2.43	0.05	53.87	3.78	0.47	0
617	2610205	15684	L-GS22-01	B 2-2	34	2.43	0.05	53.87	3.78	0.47	0
618	2620655	15684	L-GS22-01	B 2-2	34	2.43	0.05	53.87	3.78	0.47	0
619	2606389	15684	L-GS22-01	B 2-2	34	2.43	0.05	53.87	3.78	0.47	0
620	2614769	15684	L-GS22-01	B 2-2	34	2.43	0.05	53.87	3.78	0.47	0
621	2610883	15684	L-GS22-01	B 2-2	34	2.43	0.05	53.87	3.78	0.47	0
622	2618866	15684	L-GS22-01	B 2-2	34	2.43	0.05	53.87	3.78	0.47	0
623	2617106	15684	L-GS22-01	B 2-2	34	2.43	0.05	53.87	3.78	0.47	0
624	2605583	15684	L-GS22-01	B 2-2	34	2.43	0.05	53.87	3.78	0.47	0
625	2616776	15684	L-GS22-01	B 2-2	34	2.43	0.05	53.87	3.78	0.47	0
626	2405522	15684	L-GS22-01	B 2-2	30	2.46	0.06	34.68	2.98	0.45	0
627	2505025	15684	L-GS22-01	B 2-2	34	2.43	0.05	53.87	3.78	0.47	0
628	2518371	15684	L-GS22-01	B 2-2	34	2.43	0.05	53.87	3.78	0.47	0
629	2511663	15684	L-GS22-01	B 2-2	34	2.43	0.05	53.87	3.78	0.47	0
630	2504585	15684	L-GS22-01	B 2-2	34	2.43	0.05	53.87	3.78	0.47	0
631	2513717	15684	L-GS22-01	B 2-2	34	2.43	0.05	53.87	3.78	0.47	0
632	2517823	15684	L-GS22-01	B 2-2	34	2.43	0.05	53.87	3.78	0.47	0
633	2504706	15684	L-GS22-01	B 2-2	34	2.43	0.05	53.87	3.78	0.47	0
634	2506814	15684	L-GS22-01	B 2-2	34	2.43	0.05	53.87	3.78	0.47	0
635	2516759	15684	L-GS22-01	B 2-2	34	2.43	0.05	53.87	3.78	0.47	0
636	2400287	15684	L-GS22-01	B 2-2	30	2.46	0.06	34.68	2.98	0.45	0
637	2406153	15684	L-GS22-01	B 2-2	30	2.46	0.06	34.68	2.98	0.45	0
638	2608003	15684	L-GS22-01	B 2-2	34	2.43	0.05	53.87	3.78	0.47	0
640	2701357	15684	L-GS22-01	B 2-2	36	2.42	0.07	41.72	4.14	0.64	0
641	2700055	15684	L-GS22-01	B 2-2	36	2.42	0.07	41.72	4.14	0.64	0

Liner Cell	Rod Number	Liner Number	Assembly Number	Liner no.	POB Category	Th-232 (kg)	U-232 (g)	U-233 (g)	U-234 (g)	U-235 (g)	U-238 (g)
642	2304138	15684	L-GS22-01	B 2-2	32	2.42	0.06	45.57	3.95	0.57	0
643	2303552	15684	L-GS22-01	B 2-2	32	2.42	0.06	45.57	3.95	0.57	0
644	2303560	15684	L-GS22-01	B 2-2	32	2.42	0.06	45.57	3.95	0.57	0
645	2103352	15684	L-GS22-01	B 2-2	28	2.45	0.06	30.09	2.67	0.40	0
646	2102225	15684	L-GS22-01	B 2-2	28	2.45	0.06	30.09	2.67	0.40	0
647	2102077	15684	L-GS22-01	B 2-2	29	2.45	0.05	28.98	2.29	0.31	0
648	2504347	15684	L-GS22-01	B 2-2	34	2.43	0.05	53.87	3.78	0.47	0
649	2516061	15684	L-GS22-01	B 2-2	34	2.43	0.05	53.87	3.78	0.47	0
650	2518142	15684	L-GS22-01	B 2-2	34	2.43	0.05	53.87	3.78	0.47	0
651	2520288	15684	L-GS22-01	B 2-2	34	2.43	0.05	53.87	3.78	0.47	0
652	2100245	15684	L-GS22-01	B 2-2	28	2.45	0.06	30.09	2.67	0.40	0
653	2504834	15684	L-GS22-01	B 2-2	34	2.43	0.05	53.87	3.78	0.47	0
654	2517289	15684	L-GS22-01	B 2-2	34	2.43	0.05	53.87	3.78	0.47	0
656	2611002	15684	L-GW52-01	B 3-2	35	2.43	0.03	55.13	3.30	0.38	0
657	2615016	15684	L-GW52-01	B 3-2	35	2.43	0.03	55.13	3.30	0.38	0
658	2601147	15684	L-GW52-01	B 3-2	35	2.43	0.03	55.13	3.30	0.38	0
659	2607031	15684	L-GW52-01	B 3-2	35	2.43	0.03	55.13	3.30	0.38	0
660	2607325	15684	L-GW52-01	B 3-2	35	2.43	0.03	55.13	3.30	0.38	0
661	2511810	15684	L-GW52-01	B 3-2	35	2.43	0.03	55.13	3.30	0.38	0
662	2520656	15684	L-GW52-01	B 3-2	35	2.43	0.03	55.13	3.30	0.38	0
663	2516850	15684	L-GW52-01	B 3-2	35	2.43	0.03	55.13	3.30	0.38	0
664	2608434	15684	L-GW52-01	B 3-2	35	2.43	0.03	55.13	3.30	0.38	0
665	2621407	15684	L-GW52-01	B 3-2	35	2.43	0.03	55.13	3.30	0.38	0
666	2602375	15684	L-GW52-01	B 3-2	35	2.43	0.03	55.13	3.30	0.38	0
667	2201178	15684	L-GW52-01	B 3-2	29	2.45	0.05	28.98	2.29	0.31	0
668	2401636	15684	L-GW52-01	B 3-2	31	2.46	0.05	34.11	2.62	0.37	0

Liner Cell	Rod Number	Liner Number	Assembly Number	Liner no.	POB Category	Th-232 (kg)	U-232 (g)	U-233 (g)	U-234 (g)	U-235 (g)	U-238 (g)
669	2402314	15684	L-GW52-01	B 3-2	31	2.46	0.05	34.11	2.62	0.37	0
670	2605152	15684	L-GW52-01	B 3-2	35	2.43	0.03	55.13	3.30	0.38	0
671	2600653	15684	L-GW52-01	B 3-2	35	2.43	0.03	55.13	3.30	0.38	0
672	2606775	15684	L-GW52-01	B 3-2	35	2.43	0.03	55.13	3.30	0.38	0
673	2603383	15684	L-GW52-01	B 3-2	35	2.43	0.03	55.13	3.30	0.38	0
674	2620509	15684	L-GW52-01	B 3-2	35	2.43	0.03	55.13	3.30	0.38	0
101	2502616	15685	Calibration	N/A	Unirrad	2.43	0.00	63.14	0.75	0.05	0
102	25064	15685	Calibration	N/A	Unirrad	2.49	0.00	11.65	0.14	0.01	0
103	25123	15685	Calibration	N/A	Unirrad	2.47	0.00	27.94	0.33	0.02	0
104	25163	15685	Calibration	N/A	Unirrad	2.46	0.00	38.17	0.51	0.03	0
154	1612146	15685	L-GS22-01	B 2-2	26	2.89	0.09	52.10	4.74	0.75	0
155	1605629	15685	L-GU51-01	B 1-3	25	2.89	0.10	52.19	4.92	0.80	0
156	2620628	15685	L-GW52-01	B 3-2	35	2.43	0.03	55.13	3.30	0.38	0
157	1407712	15685	L-GU51-01	B 1-3	16	2.92	0.09	40.74	3.63	0.61	0
158	2104416	15685	L-GS22-01	B 2-2	28	2.45	0.06	30.09	2.67	0.40	0
159	1104478	15685	L-GU51-01	B 1-3	13	2.90	0.10	35.40	3.25	0.54	0
160	1503329	15685	L-GU51-01	B 1-3	22	2.88	0.10	47.04	4.66	0.76	0
161	1105055	15685	L-GS22-01	B 2-2	14	2.90	0.09	34.30	2.98	0.47	0
162	1203626	15685	L-GW52-01	B 3-2	15	2.91	0.08	33.30	2.73	0.41	0
163	1402762	15685	L-GU51-01	B 1-3	16	2.92	0.09	40.74	3.63	0.61	0
164	1601036	15685	L-GU51-01	B 1-3	25	2.89	0.10	52.19	4.92	0.80	0
165	1600616	15685	L-GS22-01	B 2-2	26	2.89	0.09	52.10	4.74	0.75	0
166	2606243	15685	L-GW52-01	B 3-2	35	2.43	0.03	55.13	3.30	0.38	0
167	2620316	15685	L-GW52-01	B 3-2	35	2.43	0.03	55.13	3.30	0.38	0
168	2402249	15685	L-GW52-01	B 3-2	31	2.46	0.05	34.11	2.62	0.37	0
169	2204525	15685	L-GW52-01	B 3-2	29	2.45	0.05	28.98	2.29	0.31	0

Liner Cell	Rod Number	Liner Number	Assembly Number	Liner no.	POB Category	Th-232 (kg)	U-232 (g)	U-233 (g)	U-234 (g)	U-235 (g)	U-238 (g)
170	2604034	15685	L-GW52-01	B 3-2	35	2.43	0.03	55.13	3.30	0.38	0
171	2616455	15685	L-GW52-01	B 3-2	35	2.43	0.03	55.13	3.30	0.38	0
172	2618408	15685	L-GW52-01	B 3-2	35	2.43	0.03	55.13	3.30	0.38	0
173	2401672	15685	L-GW52-01	B 3-2	31	2.46	0.05	34.11	2.62	0.37	0
174	2617555	15685	L-GW52-01	B 3-2	35	2.43	0.03	55.13	3.30	0.38	0
175	2611332	15685	L-GW52-01	B 3-2	35	2.43	0.03	55.13	3.30	0.38	0
176	2605134	15685	L-GW52-01	B 3-2	35	2.43	0.03	55.13	3.30	0.38	0
177	2615429	15685	L-GW52-01	B 3-2	35	2.43	0.03	55.13	3.30	0.38	0
178	2615236	15685	L-GW52-01	B 3-2	35	2.43	0.03	55.13	3.30	0.38	0
179	2613514	15685	L-GW52-01	B 3-2	35	2.43	0.03	55.13	3.30	0.38	0
180	2202058	15685	L-GW52-01	B 3-2	29	2.45	0.05	28.98	2.29	0.31	0
181	2202132	15685	L-GW52-01	B 3-2	29	2.45	0.05	28.98	2.29	0.31	0
182	2305229	15685	L-GW52-01	B 3-2	33	2.42	0.05	46.13	3.53	0.47	0
183	2520519	15685	L-GW52-01	B 3-2	35	2.43	0.03	55.13	3.30	0.38	0
184	2517419	15685	L-GW52-01	B 3-2	35	2.43	0.03	55.13	3.30	0.38	0
185	2511508	15685	L-GW52-01	B 3-2	35	2.43	0.03	55.13	3.30	0.38	0
186	2300885	15685	L-GW52-01	B 3-2	33	2.42	0.05	46.13	3.53	0.47	0
187	2102317	15685	L-GW52-01	B 3-2	29	2.45	0.05	28.98	2.29	0.31	0
188	2518804	15685	L-GW52-01	B 3-2	35	2.43	0.03	55.13	3.30	0.38	0
189	2517354	15685	L-GW52-01	B 3-2	35	2.43	0.03	55.13	3.30	0.38	0
190	2303644	15685	L-GW52-01	B 3-2	33	2.42	0.05	46.13	3.53	0.47	0
191	2100667	15685	L-GW52-01	B 3-2	29	2.45	0.05	28.98	2.29	0.31	0
192	2102804	15685	L-GW52-01	B 3-2	29	2.45	0.05	28.98	2.29	0.31	0
193	2513753	15685	L-GW52-01	B 3-2	35	2.43	0.03	55.13	3.30	0.38	0
194	2301619	15685	L-GW52-01	B 3-2	33	2.42	0.05	46.13	3.53	0.47	0
195	2102150	15685	L-GW52-01	B 3-2	29	2.45	0.05	28.98	2.29	0.31	0

Liner Cell	Rod Number	Liner Number	Assembly Number	Liner no.	POB Category	Th-232 (kg)	U-232 (g)	U-233 (g)	U-234 (g)	U-235 (g)	U-238 (g)
196	2518720	15685	L-GW52-01	B 3-2	35	2.43	0.03	55.13	3.30	0.38	0
197	2502440	15685	L-GW52-01	B 3-2	35	2.43	0.03	55.13	3.30	0.38	0
198	2303166	15685	L-GW52-01	B 3-2	33	2.42	0.05	46.13	3.53	0.47	0
199	2200309	15685	L-GW52-01	B 3-2	29	2.45	0.05	28.98	2.29	0.31	0
200	2200648	15685	L-GW52-01	B 3-2	29	2.45	0.05	28.98	2.29	0.31	0
201	2200721	15685	L-GW52-01	B 3-2	29	2.45	0.05	28.98	2.29	0.31	0
202	2402305	15685	L-GW52-01	B 3-2	31	2.46	0.05	34.11	2.62	0.37	0
203	2600258	15685	L-GW52-01	B 3-2	35	2.43	0.03	55.13	3.30	0.38	0
204	2306356	15685	L-GW52-01	B 3-2	33	2.42	0.05	46.13	3.53	0.47	0
205	2602853	15685	L-GW52-01	B 3-2	35	2.43	0.03	55.13	3.30	0.38	0
206	2617077	15685	L-GW52-01	B 3-2	35	2.43	0.03	55.13	3.30	0.38	0
207	2618004	15685	L-GW52-01	B 3-2	35	2.43	0.03	55.13	3.30	0.38	0
208	2621636	15685	L-GW52-01	B 3-2	35	2.43	0.03	55.13	3.30	0.38	0
209	2605125	15685	L-GW52-01	B 3-2	35	2.43	0.03	55.13	3.30	0.38	0
210	2617537	15685	L-GW52-01	B 3-2	35	2.43	0.03	55.13	3.30	0.38	0
211	2601064	15685	L-GW52-01	B 3-2	35	2.43	0.03	55.13	3.30	0.38	0
212	2620269	15685	L-GW52-01	B 3-2	35	2.43	0.03	55.13	3.30	0.38	0
213	2622368	15685	L-GW52-01	B 3-2	35	2.43	0.03	55.13	3.30	0.38	0
214	2406236	15685	L-GW52-01	B 3-2	31	2.46	0.05	34.11	2.62	0.37	0
215	2405605	15685	L-GW52-01	B 3-2	31	2.46	0.05	34.11	2.62	0.37	0
216	2400572	15685	L-GW52-01	B 3-2	31	2.46	0.05	34.11	2.62	0.37	0
217	2404155	15685	L-GW52-01	B 3-2	31	2.46	0.05	34.11	2.62	0.37	0
218	2404247	15685	L-GW52-01	B 3-2	31	2.46	0.05	34.11	2.62	0.37	0
219	2401158	15685	L-GW52-01	B 3-2	31	2.46	0.05	34.11	2.62	0.37	0
220	2201629	15685	L-GW52-01	B 3-2	29	2.45	0.05	28.98	2.29	0.31	0
221	2104167	15685	L-GW52-01	B 3-2	29	2.45	0.05	28.98	2.29	0.31	0

Liner Cell	Rod Number	Liner Number	Assembly Number	Liner no.	POB Category	Th-232 (kg)	U-232 (g)	U-233 (g)	U-234 (g)	U-235 (g)	U-238 (g)
222	2103408	15685	L-GW52-01	B 3-2	29	2.45	0.05	28.98	2.29	0.31	0
223	2103058	15685	L-GW52-01	B 3-2	29	2.45	0.05	28.98	2.29	0.31	0
224	2305568	15685	L-GW52-01	B 3-2	33	2.42	0.05	46.13	3.53	0.47	0
225	2306026	15685	L-GW52-01	B 3-2	33	2.42	0.05	46.13	3.53	0.47	0
226	2303029	15685	L-GW52-01	B 3-2	33	2.42	0.05	46.13	3.53	0.47	0
227	2305752	15685	L-GW52-01	B 3-2	33	2.42	0.05	46.13	3.53	0.47	0
228	2304037	15685	L-GW52-01	B 3-2	33	2.42	0.05	46.13	3.53	0.47	0
229	2302700	15685	L-GW52-01	B 3-2	33	2.42	0.05	46.13	3.53	0.47	0
230	2701348	15685	L-GW52-01	B 3-2	37	2.42	0.07	41.78	4.04	0.62	0
231	2700165	15685	L-GW52-01	B 3-2	37	2.42	0.07	41.78	4.04	0.62	0
232	2507418	15685	L-GW52-01	B 3-2	35	2.43	0.03	55.13	3.30	0.38	0
233	2505723	15685	L-GW52-01	B 3-2	35	2.43	0.03	55.13	3.30	0.38	0
234	2507344	15685	L-GW52-01	B 3-2	35	2.43	0.03	55.13	3.30	0.38	0
235	2501359	15685	L-GW52-01	B 3-2	35	2.43	0.03	55.13	3.30	0.38	0
236	2502477	15685	L-GW52-01	B 3-2	35	2.43	0.03	55.13	3.30	0.38	0
237	2510572	15685	L-GW52-01	B 3-2	35	2.43	0.03	55.13	3.30	0.38	0
238	2515310	15685	L-GW52-01	B 3-2	35	2.43	0.03	55.13	3.30	0.38	0
239	2511378	15685	L-GW52-01	B 3-2	35	2.43	0.03	55.13	3.30	0.38	0
240	2511562	15685	L-GW52-01	B 3-2	35	2.43	0.03	55.13	3.30	0.38	0
241	2511737	15685	L-GW52-01	B 3-2	35	2.43	0.03	55.13	3.30	0.38	0
242	2506428	15685	L-GW52-01	B 3-2	35	2.43	0.03	55.13	3.30	0.38	0
243	2507133	15685	L-GW52-01	B 3-2	35	2.43	0.03	55.13	3.30	0.38	0
244	2511306	15685	L-GW52-01	B 3-2	35	2.43	0.03	55.13	3.30	0.38	0
245	2615079	15685	L-GW52-01	B 3-2	35	2.43	0.03	55.13	3.30	0.38	0
246	2620334	15685	L-GW52-01	B 3-2	35	2.43	0.03	55.13	3.30	0.38	0
247	2614778	15685	L-GW52-01	B 3-2	35	2.43	0.03	55.13	3.30	0.38	0

Liner Cell	Rod Number	Liner Number	Assembly Number	Liner no.	POB Category	Th-232 (kg)	U-232 (g)	U-233 (g)	U-234 (g)	U-235 (g)	U-238 (g)
248	2602348	15685	L-GW52-01	B 3-2	35	2.43	0.03	55.13	3.30	0.38	0
249	2616832	15685	L-GW52-01	B 3-2	35	2.43	0.03	55.13	3.30	0.38	0
250	2618417	15685	L-GW52-01	B 3-2	35	2.43	0.03	55.13	3.30	0.38	0
251	2616805	15685	L-GW52-01	B 3-2	35	2.43	0.03	55.13	3.30	0.38	0
252	2605620	15685	L-GW52-01	B 3-2	35	2.43	0.03	55.13	3.30	0.38	0
253	2613467	15685	L-GW52-01	B 3-2	35	2.43	0.03	55.13	3.30	0.38	0
254	2600047	15685	L-GW52-01	B 3-2	35	2.43	0.03	55.13	3.30	0.38	0
255	2622579	15685	L-GW52-01	B 3-2	35	2.43	0.03	55.13	3.30	0.38	0
256	2606546	15685	L-GW52-01	B 3-2	35	2.43	0.03	55.13	3.30	0.38	0
257	2517473	15685	L-GW52-01	B 3-2	35	2.43	0.03	55.13	3.30	0.38	0
258	2512543	15685	L-GW52-01	B 3-2	35	2.43	0.03	55.13	3.30	0.38	0
259	2515255	15685	L-GW52-01	B 3-2	35	2.43	0.03	55.13	3.30	0.38	0
260	2518068	15685	L-GW52-01	B 3-2	35	2.43	0.03	55.13	3.30	0.38	0
261	2500039	15685	L-GW52-01	B 3-2	35	2.43	0.03	55.13	3.30	0.38	0
262	2511746	15685	L-GW52-01	B 3-2	35	2.43	0.03	55.13	3.30	0.38	0
263	2513423	15685	L-GW52-01	B 3-2	35	2.43	0.03	55.13	3.30	0.38	0
264	1107127	15685	L-GW52-01	B 3-2	15	2.91	0.08	33.30	2.73	0.41	0
265	1608552	15685	L-GW52-01	B 3-2	27	2.90	0.09	52.06	4.53	0.70	0
266	1402625	15685	L-GW52-01	B 3-2	18	2.92	0.08	39.40	3.21	0.50	0
267	1208785	15685	L-GW52-01	B 3-2	15	2.91	0.08	33.30	2.73	0.41	0
268	1203507	15685	L-GW52-01	B 3-2	15	2.91	0.08	33.30	2.73	0.41	0
269	1200480	15685	L-GW52-01	B 3-2	15	2.91	0.08	33.30	2.73	0.41	0
270	1203139	15685	L-GW52-01	B 3-2	15	2.91	0.08	33.30	2.73	0.41	0
271	1208179	15685	L-GW52-01	B 3-2	15	2.91	0.08	33.30	2.73	0.41	0
272	1401846	15685	L-GW52-01	B 3-2	18	2.92	0.08	39.40	3.21	0.50	0
273	1304202	15685	L-GW52-01	B 3-2	21	2.87	0.08	46.59	4.02	0.63	0

Liner Cell	Rod Number	Liner Number	Assembly Number	Liner no.	POB Category	Th-232 (kg)	U-232 (g)	U-233 (g)	U-234 (g)	U-235 (g)	U-238 (g)
274	1107118	15685	L-GW52-01	B 3-2	15	2.91	0.08	33.30	2.73	0.41	0
275	1101308	15685	L-GW52-01	B 3-2	15	2.91	0.08	33.30	2.73	0.41	0
276	1104709	15685	L-GW52-01	B 3-2	15	2.91	0.08	33.30	2.73	0.41	0
277	1101876	15685	L-GW52-01	B 3-2	15	2.91	0.08	33.30	2.73	0.41	0
278	1100529	15685	L-GW52-01	B 3-2	15	2.91	0.08	33.30	2.73	0.41	0
279	1306667	15685	L-GW52-01	B 3-2	21	2.87	0.08	46.59	4.02	0.63	0
280	1304835	15685	L-GW52-01	B 3-2	21	2.87	0.08	46.59	4.02	0.63	0
281	1304725	15685	L-GW52-01	B 3-2	21	2.87	0.08	46.59	4.02	0.63	0
282	1611376	15685	L-GW52-01	B 3-2	27	2.90	0.09	52.06	4.53	0.70	0
283	1607618	15685	L-GW52-01	B 3-2	27	2.90	0.09	52.06	4.53	0.70	0
284	1412763	15685	L-GW52-01	B 3-2	18	2.92	0.08	39.40	3.21	0.50	0
285	1401056	15685	L-GW52-01	B 3-2	18	2.92	0.08	39.40	3.21	0.50	0
286	1402129	15685	L-GW52-01	B 3-2	18	2.92	0.08	39.40	3.21	0.50	0
287	1205063	15685	L-GW52-01	B 3-2	15	2.91	0.08	33.30	2.73	0.41	0
288	1200683	15685	L-GW52-01	B 3-2	15	2.91	0.08	33.30	2.73	0.41	0
289	1200720	15685	L-GW52-01	B 3-2	15	2.91	0.08	33.30	2.73	0.41	0
290	1200436	15685	L-GW52-01	B 3-2	15	2.91	0.08	33.30	2.73	0.41	0
291	1201022	15685	L-GW52-01	B 3-2	15	2.91	0.08	33.30	2.73	0.41	0
292	1105515	15685	L-GW52-01	B 3-2	15	2.91	0.08	33.30	2.73	0.41	0
293	1100235	15685	L-GW52-01	B 3-2	15	2.91	0.08	33.30	2.73	0.41	0
294	1103113	15685	L-GW52-01	B 3-2	15	2.91	0.08	33.30	2.73	0.41	0
295	1100684	15685	L-GW52-01	B 3-2	15	2.91	0.08	33.30	2.73	0.41	0
296	1101638	15685	L-GW52-01	B 3-2	15	2.91	0.08	33.30	2.73	0.41	0
297	1103755	15685	L-GW52-01	B 3-2	15	2.91	0.08	33.30	2.73	0.41	0
298	1107668	15685	L-GW52-01	B 3-2	15	2.91	0.08	33.30	2.73	0.41	0
299	1204660	15685	L-GW52-01	B 3-2	15	2.91	0.08	33.30	2.73	0.41	0

Liner Cell	Rod Number	Liner Number	Assembly Number	Liner no.	POB Category	Th-232 (kg)	U-232 (g)	U-233 (g)	U-234 (g)	U-235 (g)	U-238 (g)
300	1405584	15685	L-GW52-01	B 3-2	18	2.92	0.08	39.40	3.21	0.50	0.00
301	1405254	15685	L-GW52-01	B 3-2	18	2.92	0.08	39.40	3.21	0.50	0.00
302	1403018	15685	L-GW52-01	B 3-2	18	2.92	0.08	39.40	3.21	0.50	0.00
303	1406428	15685	L-GW52-01	B 3-2	18	2.92	0.08	39.40	3.21	0.50	0.00
304	1401644	15685	L-GW52-01	B 3-2	18	2.92	0.08	39.40	3.21	0.50	0.00
305	1405263	15685	L-GW52-01	B 3-2	18	2.92	0.08	39.40	3.21	0.50	0.00
306	1412175	15685	L-GW52-01	B 3-2	18	2.92	0.08	39.40	3.21	0.50	0.00
307	1607012	15685	L-GW52-01	B 3-2	27	2.90	0.09	52.06	4.53	0.70	0.00
308	1613127	15685	L-GW52-01	B 3-2	27	2.90	0.09	52.06	4.53	0.70	0.00
309	1614566	15685	L-GW52-01	B 3-2	27	2.90	0.09	52.06	4.53	0.70	0.00
310	1605252	15685	L-GW52-01	B 3-2	27	2.90	0.09	52.06	4.53	0.70	0.00
311	1614034	15685	L-GW52-01	B 3-2	27	2.90	0.09	52.06	4.53	0.70	0.00
312	1310427	15685	L-GW52-01	B 3-2	21	2.87	0.08	46.59	4.02	0.63	0.00
313	1311022	15685	L-GW52-01	B 3-2	21	2.87	0.08	46.59	4.02	0.63	0.00
314	1303688	15685	L-GW52-01	B 3-2	21	2.87	0.08	46.59	4.02	0.63	0.00
315	1312570	15685	L-GW52-01	B 3-2	21	2.87	0.08	46.59	4.02	0.63	0.00
316	1310106	15685	L-GW52-01	B 3-2	21	2.87	0.08	46.59	4.02	0.63	0.00
317	1312240	15685	L-GW52-01	B 3-2	21	2.87	0.08	46.59	4.02	0.63	0.00
318	1310610	15685	L-GW52-01	B 3-2	21	2.87	0.08	46.59	4.02	0.63	0.00
319	1511258	15685	L-GW52-01	B 3-2	24	2.88	0.09	46.71	4.29	0.67	0.00
320	1500258	15685	L-GW52-01	B 3-2	24	2.88	0.09	46.71	4.29	0.67	0.00
321	1505538	15685	L-GW52-01	B 3-2	24	2.88	0.09	46.71	4.29	0.67	0.00
322	1504824	15685	L-GW52-01	B 3-2	24	2.88	0.09	46.71	4.29	0.67	0.00
323	1514412	15685	L-GW52-01	B 3-2	24	2.88	0.09	46.71	4.29	0.67	0.00
324	1504319	15685	L-GW52-01	B 3-2	24	2.88	0.09	46.71	4.29	0.67	0.00
601	2302378	15685	L-GW52-01	B 3-2	33	2.42	0.05	46.13	3.53	0.47	0.00

Liner Cell	Rod Number	Liner Number	Assembly Number	Liner no.	POB Category	Th-232 (kg)	U-232 (g)	U-233 (g)	U-234 (g)	U-235 (g)	U-238 (g)
602	2100759	15685	L-GW52-01	B 3-2	29	2.45	0.05	28.98	2.29	0.31	0.00
603	2517363	15685	L-GW52-01	B 3-2	35	2.43	0.03	55.13	3.30	0.38	0.00
604	2516777	15685	L-GW52-01	B 3-2	35	2.43	0.03	55.13	3.30	0.38	0.00
605	2517704	15685	L-GW52-01	B 3-2	35	2.43	0.03	55.13	3.30	0.38	0.00
606	2511350	15685	L-GW52-01	B 3-2	35	2.43	0.03	55.13	3.30	0.38	0.00
607	2512754	15685	L-GW52-01	B 3-2	35	2.43	0.03	55.13	3.30	0.38	0.00
608	2517244	15685	L-GW52-01	B 3-2	35	2.43	0.03	55.13	3.30	0.38	0.00
609	2608755	15685	L-GW52-01	B 3-2	35	2.43	0.03	55.13	3.30	0.38	0.00
610	2605455	15685	L-GW52-01	B 3-2	35	2.43	0.03	55.13	3.30	0.38	0.00
611	2622433	15685	L-GW52-01	B 3-2	35	2.43	0.03	55.13	3.30	0.38	0.00
612	2622478	15685	L-GW52-01	B 3-2	35	2.43	0.03	55.13	3.30	0.38	0.00
613	2607471	15685	L-GW52-01	B 3-2	35	2.43	0.03	55.13	3.30	0.38	0.00
614	2611157	15685	L-GW52-01	B 3-2	35	2.43	0.03	55.13	3.30	0.38	0.00
615	2614640	15685	L-GW52-01	B 3-2	35	2.43	0.03	55.13	3.30	0.38	0.00
616	2610240	15685	L-GW52-01	B 3-2	35	2.43	0.03	55.13	3.30	0.38	0.00
617	2101758	15685	L-GW52-01	B 3-2	29	2.45	0.05	28.98	2.29	0.31	0.00
618	2515513	15685	L-GW52-01	B 3-2	35	2.43	0.03	55.13	3.30	0.38	0.00
619	2701274	15685	L-GW52-01	B 3-2	37	2.42	0.07	41.78	4.04	0.62	0.00
624	1104780	15685	Calibration	N/A	Unirrad	2.94	0.00	16.43	0.22	0.01	0.00
625	1613834	15685	Calibration	N/A	Unirrad	2.92	0.00	54.38	0.72	0.04	0.00
626	15124	15685	Calibration	N/A	Unirrad	2.91	0.00	32.83	0.48	0.05	0.00
627	1512019	15685	Calibration	N/A	Unirrad	2.91	0.00	45.53	0.61	0.04	0.00
628	1613659	15685	Calibration	N/A	Unirrad	2.92	0.00	54.40	0.72	0.04	0.00
629	15064	15685	Calibration	N/A	Unirrad	2.95	0.00	13.83	0.16	0.01	0.00
630	1103425	15685	Calibration	N/A	Unirrad	2.93	0.00	16.45	0.22	0.01	0.00
631	1412359	15685	Calibration	N/A	Unirrad	2.95	0.00	30.09	0.39	0.02	0.00

Liner Cell	Rod Number	Liner Number	Assembly Number	Liner no.	POB Category	Th-232 (kg)	U-232 (g)	U-233 (g)	U-234 (g)	U-235 (g)	U-238 (g)
632	1300545	15685	Calibration	N/A	Unirrad	2.90	0.00	45.40	0.60	0.04	0.00
633	1501827	15685	Calibration	N/A	Unirrad	2.92	0.00	45.58	0.61	0.04	0.00
634	25161	15685	Calibration	N/A	Unirrad	2.46	0.00	37.81	0.50	0.03	0.00
635	25122	15685	Calibration	N/A	Unirrad	2.47	0.00	27.93	0.33	0.02	0.00
636	2303222	15685	Calibration	N/A	Unirrad	2.43	0.00	52.58	0.64	0.04	0.00
637	2103140	15685	Calibration	N/A	Unirrad	2.47	0.00	18.97	0.26	0.02	0.00
638	2500452	15685	Calibration	N/A	Unirrad	2.43	0.00	62.96	0.73	0.04	0.00
639	25063	15685	Calibration	N/A	Unirrad	2.49	0.00	11.66	0.14	0.01	0.00
640	2700468	15685	Calibration	N/A	Unirrad	2.45	0.00	46.31	0.64	0.05	0.00
641	2701624	15685	Calibration	N/A	Unirrad	2.45	0.00	46.52	0.68	0.07	0.00
642	2402626	15685	Calibration	N/A	Unirrad	2.47	0.00	30.60	0.42	0.03	0.00
643	2100153	15685	Calibration	N/A	Unirrad	2.48	0.00	18.91	0.25	0.01	0.00
644	25001	15685	Calibration	N/A	Unirrad	2.49	0.00	0.00	0.00	0.00	0.00
645	25004	15685	Calibration	N/A	Unirrad	2.49	0.00	0.00	0.00	0.00	0.00
646	15004	15685	Calibration	N/A	Unirrad	2.96	0.00	0.00	0.00	0.00	0.00
647	15061	15685	Calibration	N/A	Unirrad	2.95	0.00	13.84	0.16	0.01	0.00
648	15002	15685	Calibration	N/A	Unirrad	2.95	0.00	0.00	0.00	0.00	0.00
649	15122	15685	Calibration	N/A	Unirrad	2.91	0.00	32.81	0.48	0.05	0.00
652	1102470	15685	L-GS22-01	B 2-2	14	2.90	0.09	34.30	2.98	0.47	0.00
653	1104525	15685	L-GS22-01	B 2-2	14	2.90	0.09	34.30	2.98	0.47	0.00
654	1106586	15685	L-GS22-01	B 2-2	14	2.90	0.09	34.30	2.98	0.47	0.00
655	1106137	15685	L-GS22-01	B 2-2	14	2.90	0.09	34.30	2.98	0.47	0.00
656	1103672	15685	L-GS22-01	B 2-2	14	2.90	0.09	34.30	2.98	0.47	0.00
657	1305787	15685	L-GS22-01	B 2-2	20	2.87	0.09	46.87	4.22	0.68	0.00
658	1311334	15685	L-GS22-01	B 2-2	20	2.87	0.09	46.87	4.22	0.68	0.00
659	1302579	15685	L-GS22-01	B 2-2	20	2.87	0.09	46.87	4.22	0.68	0.00

Liner Cell	Rod Number	Liner Number	Assembly Number	Liner no.	POB Category	Th-232 (kg)	U-232 (g)	U-233 (g)	U-234 (g)	U-235 (g)	U-238 (g)
660	1210125	15685	L-GS22-01	B 2-2	14	2.90	0.09	34.30	2.98	0.47	0
661	1210226	15685	L-GS22-01	B 2-2	14	2.90	0.09	34.30	2.98	0.47	0
662	1208657	15685	L-GS22-01	B 2-2	14	2.90	0.09	34.30	2.98	0.47	0
663	1303248	15685	L-GS22-01	B 2-2	20	2.87	0.09	46.87	4.22	0.68	0
664	1504667	15685	L-GS22-01	B 2-2	23	2.88	0.10	46.88	4.50	0.72	0
665	1507619	15685	L-GS22-01	B 2-2	23	2.88	0.10	46.88	4.50	0.72	0
666	1504658	15685	L-GS22-01	B 2-2	23	2.88	0.10	46.88	4.50	0.72	0
667	1200344	15685	L-GT22-03	B 3-6	15	2.91	0.08	33.30	2.73	0.41	0
668	1204542	15685	L-GT22-03	B 3-6	15	2.91	0.08	33.30	2.73	0.41	0
669	1410646	15685	L-GT22-03	B 3-6	18	2.92	0.08	39.40	3.21	0.50	0
670	1404448	15685	L-GT22-03	B 3-6	18	2.92	0.08	39.40	3.21	0.50	0
671	1602181	15685	L-GS22-01	B 2-2	26	2.89	0.09	52.10	4.74	0.75	0
672	1607479	15685	L-GS22-01	B 2-2	26	2.89	0.09	52.10	4.74	0.75	0
673	1603676	15685	L-GS22-01	B 2-2	26	2.89	0.09	52.10	4.74	0.75	0
674	1608083	15685	L-GS22-01	B 2-2	26	2.89	0.09	52.10	4.74	0.75	0
101	0603381	15686	L-BB01-04	S 1-1	1	0.68	0.03	24.34	2.54	0.41	0
103	0500809	15686	L-BB01-04	S 1-1	1	0.68	0.03	24.34	2.54	0.41	0
104	0301450	15686	L-BB01-04	S 1-1	7	0.70	0.03	15.29	1.89	0.33	0
105	0402072	15686	L-BB01-04	S 1-1	4	0.69	0.03	17.17	2.13	0.38	0
106	0201460	15686	L-BB01-04	S 1-1	10	0.70	0.03	13.69	1.67	0.29	0
108	0410185	15686	L-BB01-08	S 3-2	6	0.69	0.02	18.24	1.76	0.26	0
109	0205677	15686	L-BB01-08	S 3-2	12	0.71	0.02	13.82	1.32	0.19	0
110	0530132	15686	L-BB01-08	S 3-2	3	0.68	0.02	26.28	2.10	0.29	0
111	0532213	15686	L-BB01-08	S 3-2	3	0.68	0.02	26.28	2.10	0.29	0
112	0311003	15686	L-BB01-08	S 3-2	9	0.70	0.02	15.88	1.53	0.23	0
113	0505804	15686	L-BB01-07	S 3-1	3	0.68	0.02	26.28	2.10	0.29	0

Liner Cell	Rod Number	Liner Number	Assembly Number	Liner no.	POB Category	Th-232 (kg)	U-232 (g)	U-233 (g)	U-234 (g)	U-235 (g)	U-238 (g)
114	0407067	15686	L-BB01-07	S 3-1	6	0.69	0.02	18.24	1.76	0.26	0
115	0202478	15686	L-BB01-07	S 3-1	12	0.71	0.02	13.82	1.32	0.19	0
116	0308168	15686	L-BB01-07	S 3-1	9	0.70	0.02	15.88	1.53	0.23	0
118	0510002	15686	L-BB01-07	S 3-1	3	0.68	0.02	26.28	2.10	0.29	0
401	0504107	15686	L-BB01-04	S 1-1	1	0.68	0.03	24.34	2.54	0.41	0
402	0704628	15686	L-BB01-13	S 2-3	11	0.71	0.02	13.75	1.48	0.23	0
403	0604555	15686	L-BB01-04	S 1-1	1	0.68	0.03	24.34	2.54	0.41	0
404	0504502	15686	L-BB01-04	S 1-1	1	0.68	0.03	24.34	2.54	0.41	0
405	0607258	15686	L-BB01-07	S 3-1	3	0.68	0.02	26.28	2.10	0.29	0
406	0205154	15686	L-BB01-04	S 1-1	10	0.70	0.03	13.69	1.67	0.29	0
407	0618561	15686	L-BB01-08	S 3-2	3	0.68	0.02	26.28	2.10	0.29	0
408	0800117	15686	L-BB01-04	S 1-1	10	0.70	0.03	13.69	1.67	0.29	0
409	0602209	15686	L-BB01-04	S 1-1	1	0.68	0.03	24.34	2.54	0.41	0
410	0624153	15686	L-BB01-13	S 2-3	2	0.68	0.03	25.37	2.31	0.35	0
411	0628324	15686	L-BB01-13	S 2-3	2	0.68	0.03	25.37	2.31	0.35	0
412	0625161	15686	L-BB01-13	S 2-3	2	0.68	0.03	25.37	2.31	0.35	0
413	0628544	15686	L-BB01-13	S 2-3	2	0.68	0.03	25.37	2.31	0.35	0
414	0530224	15686	L-BB01-13	S 2-3	2	0.68	0.03	25.37	2.31	0.35	0
415	0531048	15686	L-BB01-13	S 2-3	2	0.68	0.03	25.37	2.31	0.35	0
416	0531407	15686	L-BB01-13	S 2-3	2	0.68	0.03	25.37	2.31	0.35	0
417	0530811	15686	L-BB01-13	S 2-3	2	0.68	0.03	25.37	2.31	0.35	0
418	0515574	15686	L-BB01-13	S 2-3	2	0.68	0.03	25.37	2.31	0.35	0
419	0525806	15686	L-BB01-13	S 2-3	2	0.68	0.03	25.37	2.31	0.35	0
420	0534808	15686	L-BB01-13	S 2-3	2	0.68	0.03	25.37	2.31	0.35	0
421	0408084	15686	L-BB01-13	S 2-3	5	0.69	0.03	17.72	1.93	0.31	0
422	0408645	15686	L-BB01-13	S 2-3	5	0.69	0.03	17.72	1.93	0.31	0

Liner Cell	Rod Number	Liner Number	Assembly Number	Liner no.	POB Category	Th-232 (kg)	U-232 (g)	U-233 (g)	U-234 (g)	U-235 (g)	U-238 (g)
423	0412358	15686	L-BB01-13	S 2-3	5	0.69	0.03	17.72	1.93	0.31	0
424	0412515	15686	L-BB01-13	S 2-3	5	0.69	0.03	17.72	1.93	0.31	0
425	0411507	15686	L-BB01-13	S 2-3	5	0.69	0.03	17.72	1.93	0.31	0
426	0310655	15686	L-BB01-13	S 2-3	8	0.70	0.03	15.60	1.70	0.28	0
427	0314476	15686	L-BB01-13	S 2-3	8	0.70	0.03	15.60	1.70	0.28	0
428	0316126	15686	L-BB01-13	S 2-3	8	0.70	0.03	15.60	1.70	0.28	0
429	0315026	15686	L-BB01-13	S 2-3	8	0.70	0.03	15.60	1.70	0.28	0
430	0313533	15686	L-BB01-13	S 2-3	8	0.70	0.03	15.60	1.70	0.28	0
431	0210106	15686	L-BB01-13	S 2-3	11	0.71	0.02	13.75	1.48	0.23	0
432	0211462	15686	L-BB01-13	S 2-3	11	0.71	0.02	13.75	1.48	0.23	0
433	0204202	15686	L-BB01-13	S 2-3	11	0.71	0.02	13.75	1.48	0.23	0
434	0212719	15686	L-BB01-13	S 2-3	11	0.71	0.02	13.75	1.48	0.23	0
435	0214486	15686	L-BB01-13	S 2-3	11	0.71	0.02	13.75	1.48	0.23	0
436	0704664	15686	L-BB01-13	S 2-3	11	0.71	0.02	13.75	1.48	0.23	0
437	0705048	15686	L-BB01-13	S 2-3	11	0.71	0.02	13.75	1.48	0.23	0
438	0626068	15686	L-BB01-13	S 2-3	2	0.68	0.03	25.37	2.31	0.35	0
439	0623659	15686	L-BB01-13	S 2-3	2	0.68	0.03	25.37	2.31	0.35	0
440	0515823	15686	L-BB01-13	S 2-3	2	0.68	0.03	25.37	2.31	0.35	0
441	0528058	15686	L-BB01-13	S 2-3	2	0.68	0.03	25.37	2.31	0.35	0
442	0512072	15686	L-BB01-13	S 2-3	2	0.68	0.03	25.37	2.31	0.35	0
443	0528004	15686	L-BB01-13	S 2-3	2	0.68	0.03	25.37	2.31	0.35	0
444	0530563	15686	L-BB01-13	S 2-3	2	0.68	0.03	25.37	2.31	0.35	0
445	0530114	15686	L-BB01-13	S 2-3	2	0.68	0.03	25.37	2.31	0.35	0
446	0531342	15686	L-BB01-13	S 2-3	2	0.68	0.03	25.37	2.31	0.35	0
447	0534256	15686	L-BB01-13	S 2-3	2	0.68	0.03	25.37	2.31	0.35	0
448	0411010	15686	L-BB01-13	S 2-3	5	0.69	0.03	17.72	1.93	0.31	0

Liner Cell	Rod Number	Liner Number	Assembly Number	Liner no.	POB Category	Th-232 (kg)	U-232 (g)	U-233 (g)	U-234 (g)	U-235 (g)	U-238 (g)
449	0410084	15686	L-BB01-13	S 2-3	5	0.69	0.03	17.72	1.93	0.31	0
450	0413303	15686	L-BB01-13	S 2-3	5	0.69	0.03	17.72	1.93	0.31	0
451	0411617	15686	L-BB01-13	S 2-3	5	0.69	0.03	17.72	1.93	0.31	0
452	0413045	15686	L-BB01-13	S 2-3	5	0.69	0.03	17.72	1.93	0.31	0
453	0412753	15686	L-BB01-13	S 2-3	5	0.69	0.03	17.72	1.93	0.31	0
454	0411222	15686	L-BB01-13	S 2-3	5	0.69	0.03	17.72	1.93	0.31	0
455	0410764	15686	L-BB01-13	S 2-3	5	0.69	0.03	17.72	1.93	0.31	0
456	0412616	15686	L-BB01-13	S 2-3	5	0.69	0.03	17.72	1.93	0.31	0
457	0410387	15686	L-BB01-13	S 2-3	5	0.69	0.03	17.72	1.93	0.31	0
458	0315504	15686	L-BB01-13	S 2-3	8	0.70	0.03	15.60	1.70	0.28	0
459	0315035	15686	L-BB01-13	S 2-3	8	0.70	0.03	15.60	1.70	0.28	0
460	0314734	15686	L-BB01-13	S 2-3	8	0.70	0.03	15.60	1.70	0.28	0
461	0313506	15686	L-BB01-13	S 2-3	8	0.70	0.03	15.60	1.70	0.28	0
462	0313275	15686	L-BB01-13	S 2-3	8	0.70	0.03	15.60	1.70	0.28	0
463	0314303	15686	L-BB01-13	S 2-3	8	0.70	0.03	15.60	1.70	0.28	0
464	0311700	15686	L-BB01-13	S 2-3	8	0.70	0.03	15.60	1.70	0.28	0
465	0312487	15686	L-BB01-13	S 2-3	8	0.70	0.03	15.60	1.70	0.28	0
466	0312516	15686	L-BB01-13	S 2-3	8	0.70	0.03	15.60	1.70	0.28	0
467	0314788	15686	L-BB01-13	S 2-3	8	0.70	0.03	15.60	1.70	0.28	0
468	0313423	15686	L-BB01-13	S 2-3	8	0.70	0.03	15.60	1.70	0.28	0
469	0214660	15686	L-BB01-13	S 2-3	11	0.71	0.02	13.75	1.48	0.23	0
470	0214726	15686	L-BB01-13	S 2-3	11	0.71	0.02	13.75	1.48	0.23	0
471	0216513	15686	L-BB01-13	S 2-3	11	0.71	0.02	13.75	1.48	0.23	0
472	0212277	15686	L-BB01-13	S 2-3	11	0.71	0.02	13.75	1.48	0.23	0
473	0216448	15686	L-BB01-13	S 2-3	11	0.71	0.02	13.75	1.48	0.23	0
474	0215559	15686	L-BB01-13	S 2-3	11	0.71	0.02	13.75	1.48	0.23	0

Liner Cell	Rod Number	Liner Number	Assembly Number	Liner no.	POB Category	Th-232 (kg)	U-232 (g)	U-233 (g)	U-234 (g)	U-235 (g)	U-238 (g)
475	0216686	15686	L-BB01-13	S 2-3	11	0.71	0.02	13.75	1.48	0.23	0
476	0200408	15686	L-BB01-13	S 2-3	11	0.71	0.02	13.75	1.48	0.23	0
477	0214578	15686	L-BB01-13	S 2-3	11	0.71	0.02	13.75	1.48	0.23	0
478	0700530	15686	L-BB01-13	S 2-3	11	0.71	0.02	13.75	1.48	0.23	0
479	0701209	15686	L-BB01-13	S 2-3	11	0.71	0.02	13.75	1.48	0.23	0
480	0703454	15686	L-BB01-13	S 2-3	11	0.71	0.02	13.75	1.48	0.23	0
481	0104046	15686	L-BB01-13	S 2-3	11	0.71	0.02	13.75	1.48	0.23	0
482	0104708	15686	L-BB01-13	S 2-3	11	0.71	0.02	13.75	1.48	0.23	0
483	0704325	15686	L-BB01-13	S 2-3	11	0.71	0.02	13.75	1.48	0.23	0
484	0104468	15686	L-BB01-13	S 2-3	11	0.71	0.02	13.75	1.48	0.23	0
485	0104414	15686	L-BB01-13	S 2-3	11	0.71	0.02	13.75	1.48	0.23	0
486	0105210	15686	L-BB01-13	S 2-3	11	0.71	0.02	13.75	1.48	0.23	0
487	0104477	15686	L-BB01-13	S 2-3	11	0.71	0.02	13.75	1.48	0.23	0
488	0103846	15686	L-BB01-13	S 2-3	11	0.71	0.02	13.75	1.48	0.23	0
489	0702805	15686	L-BB01-13	S 2-3	11	0.71	0.02	13.75	1.48	0.23	0
490	0800227	15686	L-BB01-07	S 3-1	12	0.71	0.02	13.82	1.32	0.19	0
491	0801482	15686	L-BB01-03	S 2-3	11	0.71	0.02	13.75	1.48	0.23	0
492	0213736	15686	L-BB01-13	S 2-3	11	0.71	0.02	13.75	1.48	0.23	0
493	0216338	15686	L-BB01-13	S 2-3	11	0.71	0.02	13.75	1.48	0.23	0
494	0215678	15686	L-BB01-13	S 2-3	11	0.71	0.02	13.75	1.48	0.23	0
495	0215707	15686	L-BB01-13	S 2-3	11	0.71	0.02	13.75	1.48	0.23	0
496	0215357	15686	L-BB01-13	S 2-3	11	0.71	0.02	13.75	1.48	0.23	0
497	0408562	15686	L-BB01-13	S 2-3	5	0.69	0.03	17.72	1.93	0.31	0
498	0215760	15686	L-BB01-13	S 2-3	11	0.71	0.02	13.75	1.48	0.23	0
499	0630553	15686	L-BB01-13	S 2-3	2	0.68	0.03	25.37	2.31	0.35	0
500	0625152	15686	L-BB01-13	S 2-3	2	0.68	0.03	25.37	2.31	0.35	0

Liner Cell	Rod Number	Liner Number	Assembly Number	Liner no.	POB Category	Th-232 (kg)	U-232 (g)	U-233 (g)	U-234 (g)	U-235 (g)	U-238 (g)
501	0314054	15686	L-BB01-13	S 2-3	8	0.70	0.03	15.60	1.70	0.28	0.00
502	0533423	15686	L-BB01-13	S 2-3	2	0.68	0.03	25.37	2.31	0.35	0.00
503	0531654	15686	L-BB01-13	S 2-3	2	0.68	0.03	25.37	2.31	0.35	0.00
504	0201746	15686	L-BB01-04	S 1-1	10	0.70	0.03	13.69	1.67	0.29	0.00
505	0502347	15686	L-BB01-07	S 3-1	3	0.68	0.02	26.28	2.10	0.29	0.00
506	0702069	15686	L-BB01-04	S 1-1	10	0.70	0.03	13.69	1.67	0.29	0.00
507	0301340	15686	L-BB01-04	S 1-1	7	0.70	0.03	15.29	1.89	0.33	0.00
508	0702161	15686	L-BB01-07	S 3-1	12	0.71	0.02	13.82	1.32	0.19	0.00
601	0603464	15686	L-BB01-04	S 1-1	1	0.68	0.03	24.34	2.54	0.41	0.00
602	0604519	15686	L-BB01-04	S 1-1	1	0.68	0.03	24.34	2.54	0.41	0.00
603	0603289	15686	L-BB01-04	S 1-1	1	0.68	0.03	24.34	2.54	0.41	0.00
604	0600577	15686	L-BB01-04	S 1-1	1	0.68	0.03	24.34	2.54	0.41	0.00
608	0607184	15686	L-BB01-04	S 1-1	1	0.68	0.03	24.34	2.54	0.41	0.00
609	0500082	15686	L-BB01-04	S 1-1	1	0.68	0.03	24.34	2.54	0.41	0.00
610	0507333	15686	L-BB01-04	S 1-1	1	0.68	0.03	24.34	2.54	0.41	0.00
611	0507782	15686	L-BB01-04	S 1-1	1	0.68	0.03	24.34	2.54	0.41	0.00
613	0501128	15686	L-BB01-04	S 1-1	1	0.68	0.03	24.34	2.54	0.41	0.00
614	0501779	15686	L-BB01-04	S 1-1	1	0.68	0.03	24.34	2.54	0.41	0.00
615	0501265	15686	L-BB01-04	S 1-1	1	0.68	0.03	24.34	2.54	0.41	0.00
616	0211224	15686	L-BB01-04	S 1-1	10	0.70	0.03	13.69	1.67	0.29	0.00
617	0532120	15686	L-BB01-08	S 3-2	3	0.68	0.02	26.28	2.10	0.29	0.00
618	0605269	15686	L-BB01-04	S 1-1	1	0.68	0.03	24.34	2.54	0.41	0.00
619	0601504	15686	L-BB01-04	S 1-1	1	0.68	0.03	24.34	2.54	0.41	0.00
620	0608165	15686	L-BB01-04	S 1-1	1	0.68	0.03	24.34	2.54	0.41	0.00
621	0700219	15686	L-BB01-04	S 1-1	10	0.70	0.03	13.69	1.67	0.29	0.00
622	0100821	15686	L-BB01-04	S 1-1	10	0.70	0.03	13.69	1.67	0.29	0.00

Liner Cell	Rod Number	Liner Number	Assembly Number	Liner no.	POB Category	Th-232 (kg)	U-232 (g)	U-233 (g)	U-234 (g)	U-235 (g)	U-238 (g)
623	0608313	15686	L-BB01-04	S 1-1	1	0.68	0.03	24.34	2.54	0.41	0
624	0606378	15686	L-BB01-04	S 1-1	1	0.68	0.03	24.34	2.54	0.41	0
625	0606461	15686	L-BB01-04	S 1-1	1	0.68	0.03	24.34	2.54	0.41	0
626	0605572	15686	L-BB01-04	S 1-1	1	0.68	0.03	24.34	2.54	0.41	0
627	0537510	15686	L-BB01-08	S 3-2	3	0.68	0.02	26.28	2.10	0.29	0
628	0537069	15686	L-BB01-08	S 3-2	3	0.68	0.02	26.28	2.10	0.29	0
629	0518333	15686	L-BB01-08	S 3-2	3	0.68	0.02	26.28	2.10	0.29	0
630	0516133	15686	L-BB01-08	S 3-2	3	0.68	0.02	26.28	2.10	0.29	0
631	0536272	15686	L-BB01-08	S 3-2	3	0.68	0.02	26.28	2.10	0.29	0
632	0511625	15686	L-BB01-08	S 3-2	3	0.68	0.02	26.28	2.10	0.29	0
633	0517269	15686	L-BB01-08	S 3-2	3	0.68	0.02	26.28	2.10	0.29	0
634	0608753	15686	L-BB01-08	S 3-2	3	0.68	0.02	26.28	2.10	0.29	0
635	0613676	15686	L-BB01-08	S 3-2	3	0.68	0.02	26.28	2.10	0.29	0
636	0630680	15686	L-BB01-08	S 3-2	3	0.68	0.02	26.28	2.10	0.29	0
637	0606681	15686	L-BB01-04	S 1-1	1	0.68	0.03	24.34	2.54	0.41	0
638	0624824	15686	L-BB01-08	S 3-2	3	0.68	0.02	26.28	2.10	0.29	0
639	0412652	15686	L-BB01-08	S 3-2	6	0.69	0.02	18.24	1.76	0.26	0
640	0408755	15686	L-BB01-08	S 3-2	6	0.69	0.02	18.24	1.76	0.26	0
641	0202525	15686	L-BB01-08	S 3-2	12	0.71	0.02	13.82	1.32	0.19	0
642	0314384	15686	L-BB01-08	S 3-2	9	0.70	0.02	15.88	1.53	0.23	0
643	0315127	15686	L-BB01-08	S 3-2	9	0.70	0.02	15.88	1.53	0.23	0
644	0105624	15686	L-BB01-08	S 3-2	12	0.71	0.02	13.82	1.32	0.19	0
645	0106089	15686	L-BB01-08	S 3-2	12	0.71	0.02	13.82	1.32	0.19	0
646	0615216	15686	L-BB01-08	S 3-2	3	0.68	0.02	26.28	2.10	0.29	0
647	0622889	15686	L-BB01-08	S 3-2	3	0.68	0.02	26.28	2.10	0.29	0
648	0618543	15686	L-BB01-08	S 3-2	3	0.68	0.02	26.28	2.10	0.29	0

Liner Cell	Rod Number	Liner Number	Assembly Number	Liner no.	POB Category	Th-232 (kg)	U-232 (g)	U-233 (g)	U-234 (g)	U-235 (g)	U-238 (g)
649	0504648	15686	L-BB01-04	S 1-1	1	0.68	0.03	24.34	2.54	0.41	0
650	0524302	15686	L-BB01-08	S 3-2	3	0.68	0.02	26.28	2.10	0.29	0
651	0526336	15686	L-BB01-08	S 3-2	3	0.68	0.02	26.28	2.10	0.29	0
652	0531728	15686	L-BB01-08	S 3-2	3	0.68	0.02	26.28	2.10	0.29	0
653	0523779	15686	L-BB01-08	S 3-2	3	0.68	0.02	26.28	2.10	0.29	0
654	0627076	15686	L-BB01-08	S 3-2	3	0.68	0.02	26.28	2.10	0.29	0
655	0606874	15686	L-BB01-08	S 3-2	3	0.68	0.02	26.28	2.10	0.29	0
656	0607561	15686	L-BB01-08	S 3-2	3	0.68	0.02	26.28	2.10	0.29	0
657	0601558	15686	L-BB01-08	S 3-2	3	0.68	0.02	26.28	2.10	0.29	0
658	0505362	15686	L-BB01-07	S 3-1	3	0.68	0.02	26.28	2.10	0.29	0
659	0506388	15686	L-BB01-07	S 3-1	3	0.68	0.02	26.28	2.10	0.29	0
660	0507039	15686	L-BB01-07	S 3-1	3	0.68	0.02	26.28	2.10	0.29	0
661	0510139	15686	L-BB01-07	S 3-1	3	0.68	0.02	26.28	2.10	0.29	0
662	0610275	15686	L-BB01-08	S 3-2	3	0.68	0.02	26.28	2.10	0.29	0
663	0617865	15686	L-BB01-08	S 3-2	3	0.68	0.02	26.28	2.10	0.29	0
664	0207428	15686	L-BB01-08	S 3-2	12	0.71	0.02	13.82	1.32	0.19	0
665	0603327	15686	L-BB01-04	S 1-1	1	0.68	0.03	24.34	2.54	0.41	0
666	0502200	15686	L-BB01-07	S 3-1	3	0.68	0.02	26.28	2.10	0.29	0
667	0506206	15686	L-BB01-07	S 3-1	3	0.68	0.02	26.28	2.10	0.29	0
668	0504363	15686	L-BB01-07	S 3-1	3	0.68	0.02	26.28	2.10	0.29	0
669	0508617	15686	L-BB01-07	S 3-1	3	0.68	0.02	26.28	2.10	0.29	0
670	0407702	15686	L-BB01-07	S 3-1	6	0.69	0.02	18.24	1.76	0.26	0
671	0400083	15686	L-BB01-07	S 3-1	6	0.69	0.02	18.24	1.76	0.26	0
672	0203652	15686	L-BB01-07	S 3-1	12	0.71	0.02	13.82	1.32	0.19	0
673	0201342	15686	L-BB01-07	S 3-1	12	0.71	0.02	13.82	1.32	0.19	0
674	0500385	15686	L-BB01-07	S 3-1	3	0.68	0.02	26.28	2.10	0.29	0

D-40

Liner Cell	Rod Number	Liner Number	Assembly Number	Liner no.	POB Category	Th-232 (kg)	U-232 (g)	U-233 (g)	U-234 (g)	U-235 (g)	U-238 (g)
675	0501808	15686	L-BB01-07	S 3-1	3	0.68	0.02	26.28	2.10	0.29	0.00
676	0506453	15686	L-BB01-07	S 3-1	3	0.68	0.02	26.28	2.10	0.29	0.00
677	0502585	15686	L-BB01-07	S 3-1	3	0.68	0.02	26.28	2.10	0.29	0.00
678	0503622	15686	L-BB01-07	S 3-1	3	0.68	0.02	26.28	2.10	0.29	0.00
679	0504556	15686	L-BB01-07	S 3-1	3	0.68	0.02	26.28	2.10	0.29	0.00
680	0508451	15686	L-BB01-07	S 3-1	3	0.68	0.02	26.28	2.10	0.29	0.00
681	0508671	15686	L-BB01-07	S 3-1	3	0.68	0.02	26.28	2.10	0.29	0.00
682	0508516	15686	L-BB01-07	S 3-1	3	0.68	0.02	26.28	2.10	0.29	0.00
683	0302845	15686	L-BB01-07	S 3-1	9	0.70	0.02	15.88	1.53	0.23	0.00
684	0302203	15686	L-BB01-07	S 3-1	9	0.70	0.02	15.88	1.53	0.23	0.00
685	0701153	15686	L-BB01-07	S 3-1	12	0.71	0.02	13.82	1.32	0.19	0.00
686	0603684	15686	L-BB01-07	S 3-1	3	0.68	0.02	26.28	2.10	0.29	0.00
687	0604472	15686	L-BB01-07	S 3-1	3	0.68	0.02	26.28	2.10	0.29	0.00
688	0600430	15686	L-BB01-07	S 3-1	3	0.68	0.02	26.28	2.10	0.29	0.00
689	0602878	15686	L-BB01-07	S 3-1	3	0.68	0.02	26.28	2.10	0.29	0.00
690	0100683	15686	L-BB01-07	S 3-1	12	0.71	0.02	13.82	1.32	0.19	0.00
691	0102609	15686	L-BB01-07	S 3-1	12	0.71	0.02	13.82	1.32	0.19	0.00
692	0600633	15686	L-BB01-07	S 3-1	3	0.68	0.02	26.28	2.10	0.29	0.00
693	0608349	15686	L-BB01-07	S 3-1	3	0.68	0.02	26.28	2.10	0.29	0.00
694	0602108	15686	L-BB01-07	S 3-1	3	0.68	0.02	26.28	2.10	0.29	0.00
695	0604876	15686	L-BB01-07	S 3-1	3	0.68	0.02	26.28	2.10	0.29	0.00
696	0414466	15686	Calibration	N/A	Unirrad	0.70	0.00	24.08	0.32	0.02	0.00
697	0100500	15686	Calibration	N/A	Unirrad	0.72	0.00	14.20	0.19	0.02	0.00
698	0301754	15686	Calibration	N/A	Unirrad	0.71	0.00	19.11	0.23	0.00	0.00
699	0511165	15686	Calibration	N/A	Unirrad	0.69	0.00	34.55	0.43	0.01	0.00
700	05001	15686	Calibration	N/A	Unirrad	0.75	0.00	0.00	0.00	0.00	0.00

D-41

Liner Cell	Rod Number	Liner Number	Assembly Number	Liner no.	POB Category	Th-232 (kg)	U-232 (g)	U-233 (g)	U-234 (g)	U-235 (g)	U-238 (g)
701	05061	15686	Calibration	N/A	Unirrad	0.73	0.00	3.40	0.04	0.00	0.00
702	05431	15686	Calibration	N/A	Unirrad	0.70	0.00	28.71	0.35	0.01	0.00
703	05274	15686	Calibration	N/A	Unirrad	0.71	0.00	18.29	0.22	0.02	0.00
704	0307748	15686	Calibration	N/A	Unirrad	0.71	0.00	19.15	0.26	0.03	0.00
705	05062	15686	Calibration	N/A	Unirrad	0.73	0.00	3.40	0.04	0.00	0.00
706	0101334	15686	Calibration	N/A	Unirrad	0.72	0.00	14.28	0.19	0.02	0.00
707	05004	15686	Calibration	N/A	Unirrad	0.75	0.00	0.00	0.00	0.00	0.00
708	05122	15686	Calibration	N/A	Unirrad	0.72	0.00	8.13	0.10	0.01	0.00
709	0401863	15686	Calibration	N/A	Unirrad	0.70	0.00	23.70	0.32	0.03	0.00
710	05121	15686	Calibration	N/A	Unirrad	0.72	0.00	8.13	0.96	0.01	0.00
711	0527674	15686	Calibration	N/A	Unirrad	0.69	0.00	34.80	0.46	0.03	0.00
712	05273	15686	Calibration	N/A	Unirrad	0.71	0.00	18.31	0.22	0.02	0.00
713	05432	15686	Calibration	N/A	Unirrad	0.70	0.00	28.71	0.35	0.01	0.00
741	0624465	15686	L-BB01-13	S 2-3	2	0.68	0.03	25.37	2.31	0.35	0.00
742	0615739	15686	L-BB01-13	S 2-3	2	0.68	0.03	25.37	2.31	0.35	0.00
743	0626528	15686	L-BB01-13	S 2-3	2	0.68	0.03	25.37	2.31	0.35	0.00
744	0626573	15686	L-BB01-13	S 2-3	2	0.68	0.03	25.37	2.31	0.35	0.00
745	0610239	15686	L-BB01-13	S 2-3	2	0.68	0.03	25.37	2.31	0.35	0.00
746	0610818	15686	L-BB01-13	S 2-3	2	0.68	0.03	25.37	2.31	0.35	0.00
747	0615409	15686	L-BB01-13	S 2-3	2	0.68	0.03	25.37	2.31	0.35	0.00
748	0631800	15686	L-BB01-13	S 2-3	2	0.68	0.03	25.37	2.31	0.35	0.00
749	0315310	15686	L-BB01-13	S 2-3	8	0.70	0.03	15.60	1.70	0.28	0.00
750	0622532	15686	L-BB01-13	S 2-3	2	0.68	0.03	25.37	2.31	0.35	0.00
751	0217061	15686	L-BB01-13	S 2-3	11	0.71	0.02	13.75	1.48	0.23	0.00
752	0411534	15686	L-BB01-13	S 2-3	5	0.69	0.03	17.72	1.93	0.31	0.00
753	0628315	15686	L-BB01-13	S 2-3	2	0.68	0.03	25.37	2.31	0.35	0.00

Liner Cell	Rod Number	Liner Number	Assembly Number	Liner no.	POB Category	Th-232 (kg)	U-232 (g)	U-233 (g)	U-234 (g)	U-235 (g)	U-238 (g)
754	0610607	15686	L-BB01-13	S 2-3	2	0.68	0.03	25.37	2.31	0.35	0
755	0524623	15686	L-BB01-13	S 2-3	2	0.68	0.03	25.37	2.31	0.35	0
756	0312083	15686	L-BB01-13	S 2-3	8	0.70	0.03	15.60	1.70	0.28	0
757	0531737	15686	L-BB01-13	S 2-3	2	0.68	0.03	25.37	2.31	0.35	0
758	0535154	15686	L-BB01-13	S 2-3	2	0.68	0.03	25.37	2.31	0.35	0
759	0614648	15686	L-BB01-13	S 2-3	2	0.68	0.03	25.37	2.31	0.35	0
760	0624382	15686	L-BB01-13	S 2-3	2	0.68	0.03	25.37	2.31	0.35	0
761	0618516	15686	L-BB01-13	S 2-3	2	0.68	0.03	25.37	2.31	0.35	0
762	0411056	15686	L-BB01-13	S 2-3	5	0.69	0.03	17.72	1.93	0.31	0
763	0528325	15686	L-BB01-13	S 2-3	2	0.68	0.03	25.37	2.31	0.35	0
764	0216356	15686	L-BB01-13	S 2-3	11	0.71	0.02	13.75	1.48	0.23	0
765	0623860	15686	L-BB01-13	S 2-3	2	0.68	0.03	25.37	2.31	0.35	0
766	0623724	15686	L-BB01-13	S 2-3	2	0.68	0.03	25.37	2.31	0.35	0
767	0404355	15686	L-BB01-04	S 1-1	4	0.69	0.03	17.17	2.13	0.38	0
768	0302578	15686	L-BB01-04	S 1-1	7	0.70	0.03	15.29	1.89	0.33	0
769	0502228	15686	L-BB01-04	S 1-1	1	0.68	0.03	24.34	2.54	0.41	0
770	0200343	15686	L-BB01-04	S 1-1	10	0.70	0.03	13.69	1.67	0.29	0
771	0535466	15686	L-BB01-13	S 2-3	2	0.68	0.03	25.37	2.31	0.35	0
772	0705084	15686	L-BB01-13	S 2-3	11	0.71	0.02	13.75	1.48	0.23	0
773	0527703	15686	L-BB01-13	S 2-3	2	0.68	0.03	25.37	2.31	0.35	0
774	0106614	15686	L-BB01-13	S 2-3	11	0.71	0.02	13.75	1.48	0.23	0
775	0202635	15686	L-BB01-13	S 2-3	11	0.71	0.02	13.75	1.48	0.23	0
776	0532763	15686	L-BB01-13	S 2-3	2	0.68	0.03	25.37	2.31	0.35	0
777	0536622	15686	L-BB01-13	S 2-3	2	0.68	0.03	25.37	2.31	0.35	0
778	0518387	15686	L-BB01-13	S 2-3	2	0.68	0.03	25.37	2.31	0.35	0
101	1604253	15687	L-GS22-01	B 2-2	26	2.89	0.09	52.10	4.74	0.75	0

Liner Cell	Rod Number	Liner Number	Assembly Number	Liner no.	POB Category	Th-232 (kg)	U-232 (g)	U-233 (g)	U-234 (g)	U-235 (g)	U-238 (g)
102	1408765	15687	L-GS22-01	B 2-2	17	2.92	0.09	40.74	3.63	0.61	0
103	1203662	15687	L-GS22-01	B 2-2	14	2.90	0.09	34.30	2.98	0.47	0
108	1512477	15687	L-GS22-01	B 2-2	23	2.88	0.10	46.88	4.50	0.72	0
109	1305439	15687	L-GS22-01	B 2-2	20	2.87	0.09	46.87	4.22	0.68	0
601	2202278	15687	L-GW52-01	B 3-2	29	2.45	0.05	28.98	2.29	0.31	0
602	2200805	15687	L-GW52-01	B 3-2	29	2.45	0.05	28.98	2.29	0.31	0
603	2401048	15687	L-GW52-01	B 3-2	31	2.46	0.05	34.11	2.62	0.37	0
604	2607563	15687	L-GW52-01	B 3-2	35	2.43	0.03	55.13	3.30	0.38	0
605	1607416	15687	L-GW52-01	B 3-2	27	2.90	0.09	52.06	4.53	0.70	0
606	1607075	15687	L-GW52-01	B 3-2	27	2.90	0.09	52.06	4.53	0.70	0
607	1615502	15687	L-GW52-01	B 3-2	27	2.90	0.09	52.06	4.53	0.70	0
608	1514365	15687	L-GW52-01	B 3-2	24	2.88	0.09	46.71	4.29	0.67	0
609	1513339	15687	L-GW52-01	B 3-2	24	2.88	0.09	46.71	4.29	0.67	0
610	1310187	15687	L-GW52-01	B 3-2	21	2.87	0.08	46.59	4.02	0.63	0
611	1310472	15687	L-GW52-01	B 3-2	21	2.87	0.08	46.59	4.02	0.63	0
612	1303872	15687	L-GW52-01	B 3-2	21	2.87	0.08	46.59	4.02	0.63	0
613	1105102	15687	L-GW52-01	B 3-2	15	2.91	0.08	33.30	2.73	0.41	0
614	1103012	15687	L-GW52-01	B 3-2	15	2.91	0.08	33.30	2.73	0.41	0
615	1103460	15687	L-GW52-01	B 3-2	15	2.91	0.08	33.30	2.73	0.41	0
616	1402542	15687	L-GW52-01	B 3-2	18	2.92	0.08	39.40	3.21	0.50	0
617	1410316	15687	L-GW52-01	B 3-2	18	2.92	0.08	39.40	3.21	0.50	0
618	1207520	15687	L-GW52-01	B 3-2	15	2.91	0.08	33.30	2.73	0.41	0
619	1203709	15687	L-GW52-01	B 3-2	15	2.91	0.08	33.30	2.73	0.41	0
620	1511469	15687	L-GW52-01	B 3-2	24	2.88	0.09	46.71	4.29	0.67	0
621	1401828	15687	L-GW52-01	B 3-2	18	2.92	0.08	39.40	3.21	0.50	0
622	1100767	15687	L-GW52-01	B 3-2	15	2.91	0.08	33.30	2.73	0.41	0

Liner Cell	Rod Number	Liner Number	Assembly Number	Liner no.	POB Category	Th-232 (kg)	U-232 (g)	U-233 (g)	U-234 (g)	U-235 (g)	U-238 (g)
623	2202518	15687	L-GW52-01	B 3-2	29	2.45	0.05	28.98	2.29	0.31	0
641	2516281	15687	L-GW52-01	B 3-2	35	2.43	0.03	55.13	3.30	0.38	0
642	2603044	15687	L-GW52-01	B 3-2	35	2.43	0.03	55.13	3.30	0.38	0
643	2514128	15687	L-GW52-01	B 3-2	35	2.43	0.03	55.13	3.30	0.38	0
644	2515585	15687	L-GW52-01	B 3-2	35	2.43	0.03	55.13	3.30	0.38	0
645	2621223	15687	L-GS22-01	B 2-2	34	2.43	0.05	53.87	3.78	0.47	0
646	2516503	15687	L-GW52-01	B 3-2	35	2.43	0.03	55.13	3.30	0.38	0
647	2516319	15687	L-GW52-01	B 3-2	35	2.43	0.03	55.13	3.30	0.38	0
648	1402660	15687	L-GS22-01	B 2-2	17	2.92	0.09	40.74	3.63	0.61	0
649	1505363	15687	L-GS22-01	B 2-2	23	2.88	0.10	46.88	4.50	0.72	0
650	1407748	15687	L-GS22-01	B 2-2	17	2.92	0.09	40.74	3.63	0.61	0
651	1412846	15687	L-GS22-01	B 2-2	17	2.92	0.09	40.74	3.63	0.61	0
652	1404668	15687	L-GS22-01	B 2-2	17	2.92	0.09	40.74	3.63	0.61	0
653	1401882	15687	L-GT22-03	B 3-6	18	2.92	0.08	39.40	3.21	0.50	0
654	1601164	15687	L-GT22-03	B 3-6	27	2.90	0.09	52.06	4.53	0.70	0
655	1613457	15687	L-GT22-03	B 3-6	27	2.90	0.09	52.06	4.53	0.70	0
656	1603483	15687	L-GT22-03	B 3-6	27	2.90	0.09	52.06	4.53	0.70	0
657	1104800	15687	L-GT22-03	B 3-6	15	2.91	0.08	33.30	2.73	0.41	0
658	1305724	15687	L-GT22-03	B 3-6	21	2.87	0.08	46.59	4.02	0.63	0
659	1308564	15687	L-GT22-03	B 3-6	21	2.87	0.08	46.59	4.02	0.63	0
660	1103315	15687	L-GT22-03	B 3-6	15	2.91	0.08	33.30	2.73	0.41	0
661	1101059	15687	L-GT22-03	B 3-6	15	2.91	0.08	33.30	2.73	0.41	0
662	1103443	15687	L-GT22-03	B 3-6	15	2.91	0.08	33.30	2.73	0.41	0
663	1306117	15687	L-GT22-03	B 3-6	21	2.87	0.08	46.59	4.02	0.63	0
664	1512486	15687	L-GT22-03	B 3-6	24	2.88	0.09	46.71	4.29	0.67	0
665	1513265	15687	L-GT22-03	B 3-6	24	2.88	0.09	46.71	4.29	0.67	0

Liner Cell	Rod Number	Liner Number	Assembly Number	Liner no.	POB Category	Th-232 (kg)	U-232 (g)	U-233 (g)	U-234 (g)	U-235 (g)	U-238 (g)
666	1507545	15687	L-GT22-03	B 3-6	24	2.88	0.09	46.71	4.29	0.67	0.00
667	1208078	15687	L-GU51-01	B 1-3	13	2.90	0.10	35.40	3.25	0.54	0.00
668	1401166	15687	L-GU51-01	B 1-3	16	2.92	0.09	40.74	3.63	0.61	0.00
669	1604318	15687	L-GU51-01	B 1-3	25	2.89	0.10	52.19	4.92	0.80	0.00
670	1200665	15687	L-GU51-01	B 1-3	13	2.90	0.10	35.40	3.25	0.54	0.00
671	1407187	15687	L-GU51-01	B 1-3	16	2.92	0.09	40.74	3.63	0.61	0.00
672	1605876	15687	L-GU51-01	B 1-3	25	2.89	0.10	52.19	4.92	0.80	0.00
673	1311738	15687	L-GU51-01	B 1-3	19	2.87	0.10	47.20	4.42	0.74	0.00
674	1306584	15687	L-GU51-01	B 1-3	19	2.87	0.10	47.20	4.42	0.74	0.00

Letter numbers associated with the above data and liners are as follows:

Letter	Date	Liner Numbers
WAPD-NRF(L) C-117	June 26, 1987	15685, 15686, 15687
WAPD-NRF(L) C-123	July 8, 1987	15687
WAPD-NRF(L) C-149	September 15, 1987	15683, 15685, 15686
WAPD-NRF(L) C-93	March 26, 1987	15681, 15682
WAPD-NRF(L) C-104	April 30, 1987	15683, 15684